

Current Probes

User Manual



 **ETS-LINDGREN**[®]
An ESCO Technologies Company

ETS-Lindgren Inc. reserves the right to make changes to any product described herein in order to improve function, design, or for any other reason. Nothing contained herein shall constitute ETS-Lindgren Inc. assuming any liability whatsoever arising out of the application or use of any product or circuit described herein. ETS-Lindgren Inc. does not convey any license under its patent rights or the rights of others.

© Copyright 2008-2022 by ETS-Lindgren Inc. All Rights Reserved. No part of this document may be copied by any means without written permission from ETS-Lindgren Inc.

Trademarks used in this document: The *ETS-Lindgren* logo is a trademark of ETS-Lindgren L.P.

Revision Record

MANUAL DESCRIPTION | Part #399297, Rev. D

Revision	Description	Date
A	Initial Release	December, 2008
B	Corrected spec for 91550-2	August, 2017
C	Removed discontinued probes	July, 2018
D	Warranty information removed	February, 2022

Table of Contents

Notes, Cautions, and Warnings	v
1.0 Introduction	7
ETS-Lindgren Product Information Bulletin	8
2.0 Maintenance	9
Annual Calibration	9
Service Procedures	9
3.0 Specifications	11
Model 91550-1 Current Probe.....	11
Model 91550-1 Physical Specifications	11
Model 91550-1 Electrical Specifications	11
Model 91550-1 Pulse Power Limits	12
Model 93686-8 Current Probe.....	12
Model 93686-8 Physical Specifications	12
Model 93686-8 Electrical Specifications	12
Model 94111-1 Current Probe.....	13
Model 94111-1 Physical Specifications	13
Model 94111-1 Electrical Specifications	14
Model 94111-1 Pulse Power Limits	14
4.0 Principles of Operation	15
Circuit	15
Basic RF Transformer.....	16
Sensitivity	17
Model 91550-1 Typical Sensitivity.....	17
Model 93686-8 Typical Sensitivity.....	17
Model 94111-1 Typical Sensitivity.....	18
Core Saturation and Intermodulation.....	18
Transfer Impedance.....	19
5.0 Assembly and Installation	21
Equipment Setup to Measure RF Current	21
For a Single Conductor	21
For a Two-Conductor Cable.....	21
For Multi-Conductor Cables	21

To Evaluate Shielding Effectiveness	22
Installation Instructions	22
Sample Test Configuration.....	23
6.0 Operation	25
Signal Measurement	26
Signal Injection	29
7.0 Typical Data.....	31
Model 91550-1 Current Probe.....	31
Model 91550-1 Transfer Impedance	31
Model 93686-8 Current Probe.....	32
Model 93686-8 Transfer Impedance	32
Model 94111-1 Current Probe.....	32
Model 94111-1 Transfer Impedance	32

Notes, Cautions, and Warnings

	<p>Note: Denotes helpful information intended to provide tips for better use of the product.</p>
<p>CAUTION</p>	<p>Caution: Denotes a hazard. Failure to follow instructions could result in minor personal injury and/or property damage. Included text gives proper procedures.</p>
<p>WARNING</p>	<p>Warning: Denotes a hazard. Failure to follow instructions could result in SEVERE personal injury and/or property damage. Included text gives proper procedures.</p>



See the ETS-Lindgren *Product Information Bulletin* for safety, regulatory, and other product marking information.

This page intentionally left blank.

1.0 Introduction

The **ETS-Lindgren Current Probe** is a clamp-on RF current transformer that determines the intensity of RF current present in an electrical conductor or group of conductors. The current probe is designed for use with electromagnetic interference (EMI) test receivers or spectrum analyzers, or with any similar instrument having a 50-ohm input impedance.

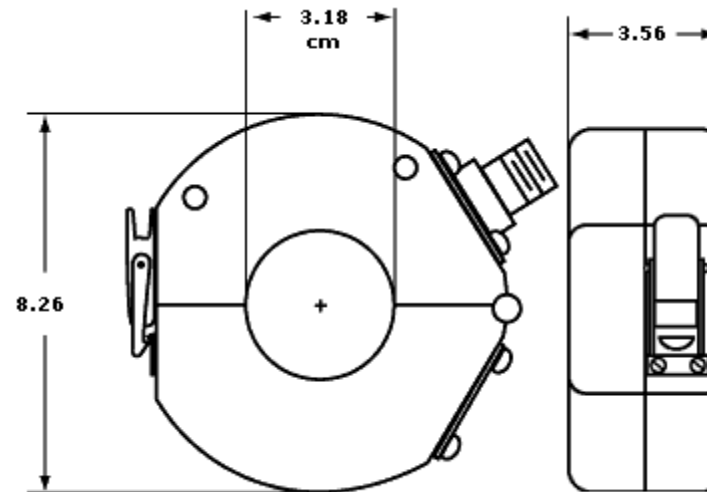

*All measurements are in centimeters

A current probe provides a way to accurately measure net (common mode) radio frequency current flowing on a wire or bundle of wires without requiring a direct connection to the conductor(s) of interest. The probe clamps around the test conductor which becomes a one turn primary winding; the probe forms the core and secondary winding of an RF transformer. Measurements can be made on single-conductor and multi-conductor cables, grounding and bonding straps, outer conductors of shielding conduits and coaxial cables, and so on.

This manual includes these ETS-Lindgren current probes:

- **Model 91550-1**
- **Model 93686-8**
- **Model 94111-1**

ETS-Lindgren Product Information Bulletin

See the ETS-Lindgren *Product Information Bulletin* included with your shipment for the following:

- Warranty information
- Safety, regulatory, and other product marking information
- Steps to receive your shipment
- Steps to return a component for service
- ETS-Lindgren calibration service
- ETS-Lindgren contact information

2.0 Maintenance

CAUTION

Before performing any maintenance, follow the safety information in the ETS-Lindgren *Product Information Bulletin* included with your shipment.



Maintenance is limited to external components such as cables or connectors.

If you have any questions concerning maintenance, contact ETS-Lindgren Customer Service.

Annual Calibration

See the *Product Information Bulletin* included with your shipment for information on ETS-Lindgren calibration services.

Service Procedures

For the steps to return a system or system component to ETS-Lindgren for service, see the *Product Information Bulletin* included with your shipment.

This page intentionally left blank.

3.0 Specifications



At the lower frequencies, the signal current I_p level can be as great as allowed for maximum power current. When both signal and power currents are high, their sum should not exceed the given limits.



L model current probes are calibrated down to 20 Hz.

Model 91550-1 Current Probe

MODEL 91550-1 PHYSICAL SPECIFICATIONS

Window Diameter:	3.18 cm (1.25 in)
Outside Diameter:	8.89 cm (3.5 in)
Width:	7.29 cm (2.87 in)
Output Connector:	Type N
Weight:	0.6 kg (1.31 lb)
Impedance:	50 Ω

MODEL 91550-1 ELECTRICAL SPECIFICATIONS

Frequency Range :	10 kHz–100 MHz
Transfer Impedance (Nominal):	5.0 $\Omega \pm 3$ dB 1 MHz–100 MHz
RF Current Range (RF CW):	42 amps
RF Current Range (Pulse):	100 amps
Maximum Power Current (DC–60 Hz):	350 amps
Maximum Power Current (400 Hz):	350 amps, 50 Hz–1500 Hz

Maximum Power Voltage:	No limitation; subject to adequate conductor insulation
Internal Loading:	No
Rated Output Load Impedance:	50 Ω
Sensitivity Under Rated Load:	0.17 microampere with 1 microvolt sensitivity receiver and 6 ohm transfer impedance

MODEL 91550-1 PULSE POWER LIMITS

RF Current Range (Pulse):	100 amps
----------------------------------	----------

Model 93686-8 Current Probe

MODEL 93686-8 PHYSICAL SPECIFICATIONS

Window Diameter:	6.65 cm (2.62 in)
Outside Diameter:	13.97 cm (5.5 in)
Width:	5.38 cm (2.12 in)
Output Connector:	Type N
Weight:	2.27 kg (5 lb)
Impedance:	50 Ω

MODEL 93686-8 ELECTRICAL SPECIFICATIONS

Frequency Range:	10 kHz–200 MHz
Transfer Impedance (Nominal):	8.0 $\Omega \pm 3$ dB 10 MHz–200 MHz
RF Current Range (RF CW):	0 amps–62 amps
RF Current Range (Pulse):	62 amps

Maximum Power Current (DC–60 Hz):	300 amps
Maximum Power Current (400 Hz):	300 amps
Maximum Power Voltage:	No limitation; subject to adequate conductor insulation
Sensitivity Under Rated Load:	0.125 microampere with 1 microvolt sensitivity receiver and 8 ohm transfer impedance
Model Maximum Power Current (400 Hz):	200 amps
Maximum Power Voltage:	No limitation; subject to adequate conductor insulation
Rated Output Load Impedance:	50 Ω
Sensitivity Under Rated Load:	0.1 microampere with 1 microvolt sensitivity receiver and 10 ohm transfer impedance

Model 94111-1 Current Probe

MODEL 94111-1 PHYSICAL SPECIFICATIONS

Window Diameter:	3.18 cm (1.25 in)
Outside Diameter:	8.89 cm (3.5 in)
Width:	3.56 cm (1.4 in)
Output Connector:	Type N
Weight:	0.42 kg (15 oz)
Impedance:	50 Ω

MODEL 94111-1 ELECTRICAL SPECIFICATIONS

Frequency Range:	1 MHz–1000 MHz
Transfer Impedance (Nominal):	<ul style="list-style-type: none"> • 0.9Ω(-1dB □Ω) ±3dB @1 MHz • 2.5Ω(8dB □Ω) □ ±3dB @10 MHz • 5Ω(14dB □Ω) □□±3dB @100 MHz • 5.6Ω(15dB Ω) ±□□3dB @500 MHz
RF Current Range (RF CW):	20.0 amps
RF Current Range (Pulse):	50 amps
Maximum Power Current (DC–400 Hz):	200 amps
Maximum Power Voltage:	No limitation; subject to adequate conductor insulation
Sensitivity Under Rated Load:	0.2 microampere with 1 microvolt sensitivity receiver and 5 ohms transfer impedance

MODEL 94111-1 PULSE POWER LIMITS

RF Current Range (Pulse):	50 amps for duty cycle less than 0.4
Maximum Power Current	(DC to 1500 Hz) 300 amps When both signal and power currents are high, their sum should not exceed the given limits

4.0 Principles of Operation

CAUTION

Before connecting any components or operating the probe, follow the safety information in the ETS-Lindgren *Product Information Bulletin* included with your shipment.

The current probe is an inserted-primary type of radio frequency current transformer. When the probe is clamped over the conductor or cable in which current is to be measured, the conductor forms the primary winding. The clamp-on feature of this probe enables easy placement around any conductor or cable.

Circuit

The circuit is that of a radio frequency transformer, as illustrated on page 16.

Because the current probe is intended for clamp-on operation, the primary shown on page 16 is the electrical conductor in which interference currents are to be measured. This primary is considered as one turn since it is assumed that the noise currents flow through the conductor and return to the source by way of a ground conductor such as a frame, common ground plane, or earth. On some current probe models the secondary output terminals are resistively loaded internally to provide substantially constant transfer impedance over a wide frequency range.

BASIC RF TRANSFORMER

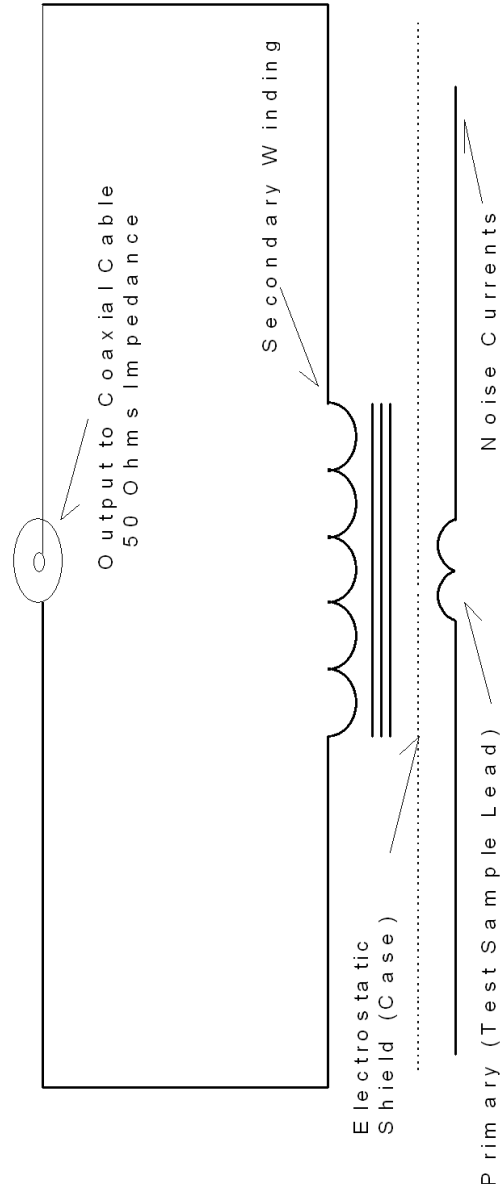

Sensitivity

Probe sensitivity in microamperes depends on the sensitivity in microvolts of the receiving equipment with which it is used. The following tables show the relationship of receiving sensitivity in microvolts to the overall sensitivity of the probe and receiver in microamperes. This data is based on the transfer impedance of each model.

MODEL 91550-1 TYPICAL SENSITIVITY

Test Equipment Sensitivity in Microvolts	91550-1 $Z_T = 5.0 \Omega$
5	1
2	0.4
1	0.2
0.1	0.02

MODEL 93686-8 TYPICAL SENSITIVITY

Test Equipment Sensitivity in Microvolts	93686-8 $Z_T = 8.0 \Omega$
4	0.5
2	0.25
1	0.125
0.1	0.0125

MODEL 94111-1 TYPICAL SENSITIVITY

Test Equipment Sensitivity in Microvolts	94111-1 $Z_T = 5.0 \Omega$
5	1
2	0.4
1	0.2
0.1	0.02

Core Saturation and Intermodulation

The magnetizing effects of a primary conductor carrying large currents at power line frequencies can saturate the current probe core material. Core saturation produces non-linear transforming action and can result in:

- A decrease in the current probe RF output for a given RF current input.
- Modulation of the RF output by the power line frequency.

CAUTION

The specified pulse duty cycle should not be exceeded or the current probe internal load resistor (if applicable) may be subject to damage. The load resistor must also be protected from excessive line currents.

The influence of intermodulation on the current probe output as measured with the EMI test equipment is negligible for primary conductor power frequency currents under 300 amperes. For primary power currents above 300 amperes, measurements taken by the EMI test equipment generally will not be affected by intermodulation due to the averaging characteristics for the quasi-peak and peak functions; the readings will increase with current.

Transfer Impedance

The RF current (I_P) in microamps in the conductor under test is determined from the reading of the current probe output in microvolts (E_S) divided by the current probe transfer impedance (Z_T).

$$I_P = \frac{E_S}{Z_T}$$

Or, in dB:

$$I_P(\text{dB}\mu\text{A}) = E_S(\text{dB}\mu\text{V}) - Z_T(\text{dB})$$

The typical transfer impedance of the current probe throughout the frequency range is shown in *Typical Data* on page 31. It is determined by passing a known RF current (I_P) through the primary test conductor and noting the voltage (E_S), developed across a 50-ohm load.

$$Z_T = \frac{E_S}{I_P}$$

This page intentionally left blank.

5.0 Assembly and Installation

CAUTION

Before connecting any components, follow the safety information in the ETS-Lindgren *Product Information Bulletin* included with your shipment.

Equipment Setup to Measure RF Current



Standing waves can exist on the test conductor under test at or near the resonant frequency. Under these conditions, several measurements taken along the line will provide a complete picture of the RF current distribution and amplitude.

FOR A SINGLE CONDUCTOR

1. Place the probe jaws around the conductor so that the conductor passes through the center opening.
2. Lock the jaws together.

FOR A TWO-CONDUCTOR CABLE

- To evaluate the common mode component of the noise current (the net effect of the currents leaving and returning): Place the probe over both conductors at the same time.
- To measure the interference current in either conductor separately: Place the probe over each wire individually.

FOR MULTI-CONDUCTOR CABLES

The probe will measure the net external effects of all the currents in the conductors that pass through the center of the probe.

To EVALUATE SHIELDING EFFECTIVENESS

When placed over shielding conduit, coaxial cable, or ignition shielding, the probe measures the current flowing on the external surface of the shield.

Installation Instructions



The window (aperture) of the probe will accommodate cables up to the following maximum outside diameters.

Current Probe	Maximum Outside Diameter
Model 91550-1	1.25 inches
Model 94111-1	1.25 inches
Model 93686-8	2.62 inches



For greatest accuracy, the conductor under measurement should be centered in the window of the current probe.

Place the probe around the conductor(s) to be measured and then carefully lock the probe jaws. Otherwise, inadequate shielding or incorrect air gap will result and the measurement will not be accurate.

The connecting cable used between the current probe and the EMI test equipment must have 50-ohm characteristic impedance and matching cable connectors. The current probe is calibrated for use only with a 50-ohm load. Therefore, the EMI test equipment must have a 50-ohm input impedance.

Observe precautions regarding minimum bending radius when installing and using the cable. For long cables and at high frequencies, cable loss may also be a factor. Use low loss cables and perform cable loss corrections if necessary.

The probe rejection of any external pickup from conductors not passing through the window is better than 60 dB. The presence of very strong magnetic fields will likely have an effect on probe sensitivity. Do not place the unit close to permanent magnets or the magnetic field structures of motors or generators.

Sample Test Configuration

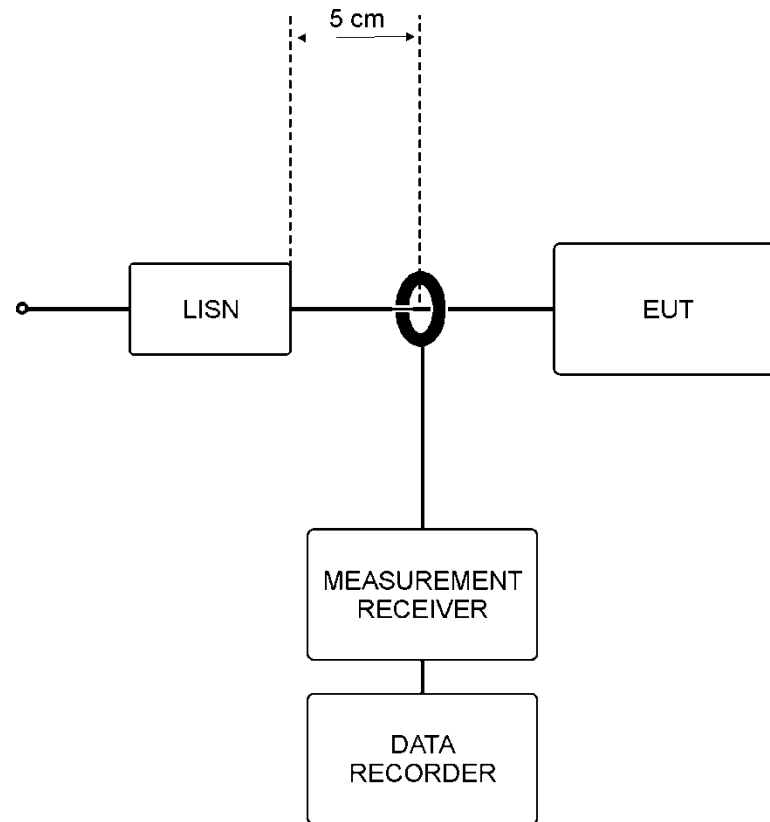

This page intentionally left blank.

6.0 Operation

CAUTION

Before connecting any components, follow the safety information in the ETS-Lindgren *Product Information Bulletin* included with your shipment.



If measuring uninsulated conductors: Use extreme care when installing the current probe and taking measurements. If possible, de-energize the test sample during assembly and disassembly of the setup. Also, arrange to center the test conductor in the current probe window for additional voltage breakdown protection.

Do not permit the uninsulated current probe connector and cable connectors to come in contact with the ground plane or other nearby conductors. This will prevent possible measurement error due to ground loops, and will avoid danger from high voltages.

Ensure that the 50-ohm load is capable of safely dissipating the incurred power. Should the load become disconnected, the developed voltage will be come much greater and may be very dangerous.

The RF current probe is a broadband RF transformer for use with EMI test equipment. Radio frequency currents can be measured in cables without physically disturbing the circuit.

Signal Measurement

OSCILLOSCOPE USE: IN TERMS OF RF AMPERES

1. Standardize the gain of the oscilloscope to correctly read the voltage (E_s) applied to the input terminals.
2. Divide E_s in volts by the average current probe transfer impedance Z_T in ohms. The result is the value of the RF signal in terms of amperes in the test conductor.

Example:

Assume an oscilloscope peak voltage measurement of 5 volts and the average Z_T to be 1.06 ohms. Then: $5/1.06 = 4.71$ amperes in the test conductor.

The example is valid providing that the oscilloscope rise time ($T = 0.3/BW$) is shorter than RF signal pulse duration. This also applies to the current probe which has a rise time of about 3 nanoseconds based on a 100 megahertz bandwidth.

IN TERMS OF dB ABOVE ONE MICROAMPERE AT METER INPUT (CW CONDUCTED MEASUREMENTS)

1. Adjust the EMI test equipment for standard gain and make a measurement of the CW signal (voltage output from the current probe) in terms of dB above one microvolt. Use procedures outlined in the EMI test equipment instruction manual.
2. Subtract the transfer impedance of the current probe in dB at the test frequency from the dB measurement of the previous step. The result is the value of the conducted CW signal in terms of dB above one microamp at meter input.



At meter input as used in the MIL-I-26600 and MIL-I-6181D specifications refers to the current in the test sample lead.

Example:

Frequency is 10.0 kHz; step 1 measurement is 52 dB above one microvolt. For example, suppose the transfer impedance of the current probe used in the example was 8.0 dB below one ohm at 10.0 kHz. Then, as outlined in step 2: 52 dB + 8.0 dB = 60 dB above one microampere at meter input.

IN TERMS OF dB ABOVE ONE MICROAMPERE PER MEGAHERTZ AT METER INPUT (BROADBAND INTERFERENCE MEASUREMENT)

1. Adjust the EMI test equipment for standard gain and make a peak measurement of the broadband interference (voltage output from the current probe) in terms of dB above one microvolt per megahertz. Use procedures outlined in the EMI test equipment instruction manual.
2. Subtract the transfer impedance of the current probe in dB at the test frequency from the dB measurement of the previous step. The result is the value of the broadband interference in terms of dB above one microamp per megahertz at meter input.



At meter input as used in the MIL-I-26600 and MIL-I-6181D specifications refers to the current in the test sample lead.

Example:

Frequency is 100 kHz; step 1 measurement is 41 dB above one microvolt per megahertz. For example, suppose the transfer impedance of the current probe was 8.0 dB below one ohm at 100 kHz. Then, as outlined in step 2: 41 dB + 8.0 dB = 49 dB above one microamp per megahertz at meter input.

This result is beyond the limit of 46.2 dB above one microamp per megahertz.

IN TERMS OF MICROAMPERE IN TEST SAMPLE LEAD (CW CONDUCTED MEASUREMENTS)

1. Adjust the EMI test equipment for standard gain and make a measurement of the CW signal (voltage output from current probe) in terms of microvolts at meter input. Use procedures outlined in the EMI test equipment instruction manual.
2. Divide the microvolt measurement of the previous step by the transfer impedance in ohms at the test frequency. The result is the value of conducted CW signal in terms of microamperes in the test sample lead.

Example:

Frequency is 3.0 kHz; step 1 measurement is 150 microvolts.
For example, suppose the transfer impedance of the current probe was 0.34 ohms. Then, as outlined in step 2, $150/0.34 = 441.1$ microamperes in the test sample lead.

IN TERMS OF MICROAMPERE PER MEGAHERTZ IN TEST SAMPLE LEAD (BROADBAND INTERFERENCE MEASUREMENT)

1. Adjust the EMI test equipment for standard gain and make a measurement of the broadband interference (voltage output from current probe), in terms of microvolts per megahertz at meter input. Use procedures outlined in the EMI test equipment instruction manual.
2. Divide the microvolt per megahertz measurement of the previous step by the transfer impedance in ohms at the test frequency. The result is the value of conducted broadband interference in terms of microamps per megahertz in the test sample lead.

Example:

Frequency is 10.0 kHz; step 1 measurement is 8000 microvolts per megahertz. For example, suppose the transfer impedance of the current probe was 0.39 ohms. Then, as outlined in step 2, $8000/0.39 = 20513$ microamps per megahertz in test sample lead.

Signal Injection



Applies to Model 94111-1 only.

Current probes may be used to inject RF currents into test conductors when performing susceptibility tests. Injection is best accomplished with current probes that do not have internal loading. Internal loading will absorb part (or most) of the driving power and can seriously limit the maximum levels of voltage and current that the current probe can handle as an injection device.

The current probe does not have an internal load and therefore is suited for signal injection. However, it will be limited by connector voltage rating (500 V) and by the thermal limit of the coil windings. A maximum continuous injection current into the current probe coils of 4.2 amps may be used; two or three times this level may be used for short periods of time. When injecting pulse signals, the average current should be held within the above limits, and the peak voltage held below 500 V.

Because of variable circuit impedances, there is no easy way to compute the RF current that may be injected into the test conductor. The practical way to determine the injected current is to measure it with a second current probe on the test conductor. The second current probe can be any model that covers the frequency range of interest.

This page intentionally left blank.

7.0 Typical Data

Model 91550-1 Current Probe

MODEL 91550-1 TRANSFER IMPEDANCE

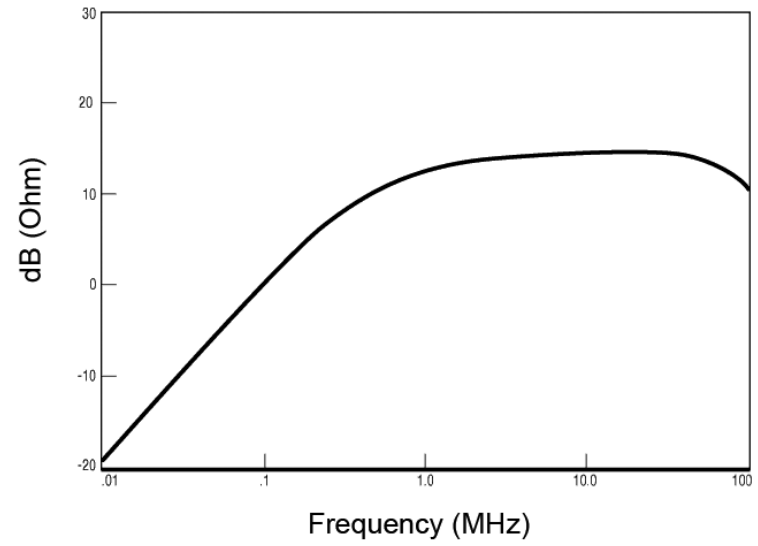

Model 93686-8 Current Probe

MODEL 93686-8 TRANSFER IMPEDANCE

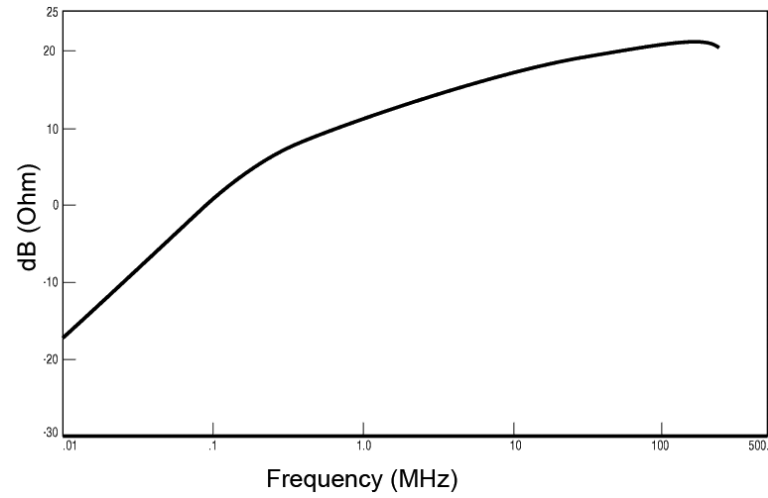

Model 94111-1 Current Probe

MODEL 94111-1 TRANSFER IMPEDANCE

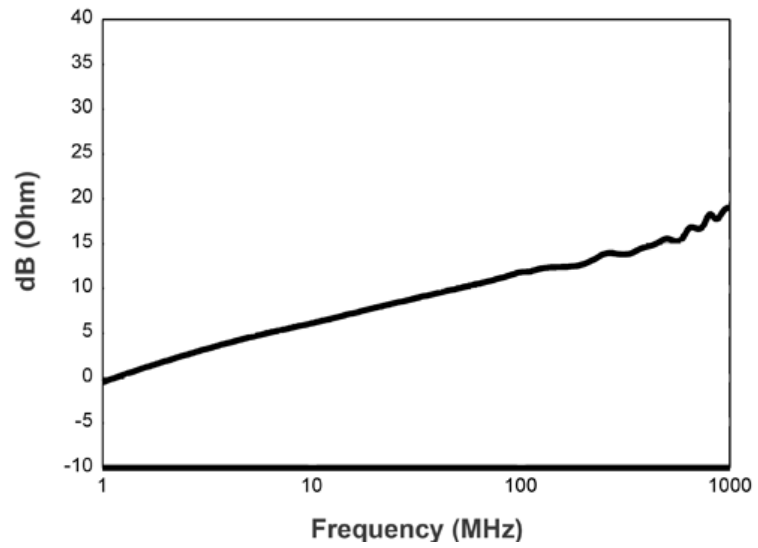

This page intentionally left blank.