

Model 3147

Log Periodic Dipole Antenna

User Manual

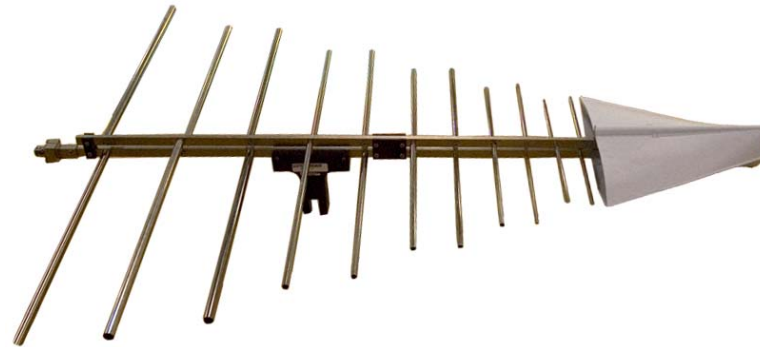

 **ETS-LINDGREN**[™]
An ESCO Technologies Company

ETS-Lindgren L.P. reserves the right to make changes to any product described herein in order to improve function, design, or for any other reason. Nothing contained herein shall constitute ETS-Lindgren L.P. assuming any liability whatsoever arising out of the application or use of any product or circuit described herein. ETS-Lindgren L.P. does not convey any license under its patent rights or the rights of others.

© Copyright 1999–2010 by ETS-Lindgren L.P. All Rights Reserved. No part of this document may be copied by any means without written permission from ETS-Lindgren L.P.

Trademarks used in this document: The *ETS-Lindgren* logo is a trademark of ETS-Lindgren L.P.

Revision Record

MANUAL 3147 LOG PERIODIC ANTENNA | Part #399160, Rev. F

Revision	Description	Date
A	Initial Release	January, 1999
B	Updated content/branding	October, 2002
C	Edited content, rebranding changes	June, 2008
D	Updated photos	April, 2009
E	<i>Added Mounting Instructions</i>	March, 2010
F	Corrected error in <i>Power Requirements</i> table; updated part numbers in <i>Mounting Instructions</i>	November, 2010

Table of Contents

Notes, Cautions, and Warnings	v
1.0 Introduction	7
Regarding Calibration of Log Periodic Dipole Antennas.....	8
ETS-Lindgren Product Information Bulletin	9
2.0 Maintenance	11
Maintenance Recommendations	11
Annual Calibration	11
Service Procedures	11
3.0 Specifications	13
Electrical Specifications	13
Physical Specifications	13
4.0 Mounting Instructions	15
Using Included Mounting Adapters.....	15
Additional Mounting Options.....	17
4-TR Mounting Options.....	17
7-TR and Mast Mounting Options.....	18
2x2 Boom Mounting Options	19
5.0 Operation	21
Model 3147 Assembly Instructions	21
Model 3147 Use.....	21
6.0 Typical Data	23
Typical VSWR for Model 3147.....	23
Typical Antenna Factor and Gain for Model 3147	24
Beamwidth for Horizontally and Vertically Polarized Model 3147.....	26
Front-to-Back Ratio for Model 3147.....	28
Cable Attenuation (dB) at 20°C for 6-M Cable.....	29
Typical Antenna Pattern for 200 MHz and 300 MHz	30
7.0 Radiated Emissions Measurement	31
Conversion Factors.....	32
8.0 Power Requirements	35
Power Requirements Table	36

80 Watts Continuous Power	36
40 Watts Continuous Power	38
Appendix A: Typical Antenna Patterns	41
400 MHz	41
500 MHz	41
600 MHz	42
700 MHz	42
800 MHz	43
900 MHz	43
1.0 GHz.....	44
1.5 GHz.....	44
2.0 GHz.....	45
2.5 GHz.....	45
3.0 GHz.....	46
3.5 GHz.....	46
4.0 GHz.....	47
4.5 GHz.....	47
5.0 GHz.....	48
Appendix B: Warranty	49

Notes, Cautions, and Warnings

	<p>Note: Denotes helpful information intended to provide tips for better use of the product.</p>
<p>CAUTION</p>	<p>Caution: Denotes a hazard. Failure to follow instructions could result in minor personal injury and/or property damage. Included text gives proper procedures.</p>
<p>WARNING</p>	<p>Warning: Denotes a hazard. Failure to follow instructions could result in SEVERE personal injury and/or property damage. Included text gives proper procedures.</p>



See the ETS-Lindgren *Product Information Bulletin* for safety, regulatory, and other product marking information.

This page intentionally left blank.

1.0 Introduction

The **ETS-Lindgren Model 3147 Log Periodic Dipole Antenna** is a linearly-polarized broadband antenna designed to operate over the frequency range of 200 MHz to 5 GHz. The antenna was designed with the latest revision to Part 15 of FCC Rules and Regulations in mind. See page 13 for specifications.

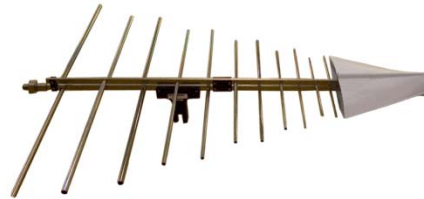

The Model 3147 is constructed from 30 elements mounted on two 6.35-mm by 12.7-mm booms. The choice of scaling factors, the various diameters of each element, and the center-to-center spacing of the booms yield excellent VSWR characteristics throughout the operating frequency range (see *VSWR* on page 23). The precise design of the feed and the positioning of the elements on the boom yield an optimum phase relationship. This causes the active region, at any given frequency, to propagate RF energy towards the smaller elements, leaving the elements behind it electrically dead.

The constant gain of the Model 3147 yields an antenna factor which varies linearly with frequency, as shown in *Typical Data* on page 23. The variation is smooth; therefore, accurate interpolation of performance between specified frequency points is simple.

Due to the relatively high upper frequency limit, the small elements on the Model 3147 are very thin. The antenna is equipped with an integral, low dielectric-constant radome to protect the elements from possible damage.

CAUTION

Do not disassemble or drop the antenna or the thin elements may be damaged.

Because the radome is almost RF-invisible, it has very little effect on the performance of the Model 3147 (see *VSWR* on page 23).

The base of the Model 3147 accepts an ETS-Lindgren or other tripod mount with 1/4–20 threads. Additionally, the antenna is shipped with a support rod. A variety of mounting options are available for the Model 3147. For information, see *Mounting Instructions* on page 15.

Regarding Calibration of Log Periodic Dipole Antennas

To meet the requirements of two different specifications, this log periodic dipole antenna was calibrated at two different spacings.

- SAE ARP 958 (Society of Automotive Engineers, Aerospace Recommended Practice) requires an antenna spacing of one meter, measured tip to tip.
- ANSI 63.5 requires a spacing of three and ten meters measured from the projection onto the ground plane of the midpoint of the longitudinal axis of the antenna.

The ARP and the ANSI requirements disagree because these standards were written for different purposes. Therefore, when calibrating the log periodic array antennas per ARP 958, ETS-Lindgren measures from tip to tip and sets the spacing to one meter. When calibrating the log periodic array antennas per ANSI C63.5, ETS-Lindgren measures from the midpoint to the midpoint of the log periodic antennas for 3-meter and 10-meter calibrations.



It is important in compliance demonstration testing to measure the spacing from the antenna to the Equipment Under Test (EUT) as it was measured when calibration was performed.

For additional information, contact ETS-Lindgren.

ETS-Lindgren Product Information Bulletin

See the ETS-Lindgren *Product Information Bulletin* included with your shipment for the following:

- Warranty information
- Safety, regulatory, and other product marking information
- Steps to receive your shipment
- Steps to return a component for service
- ETS-Lindgren calibration service
- ETS-Lindgren contact information

This page intentionally left blank.

2.0 Maintenance

CAUTION

Before performing any maintenance, follow the safety information in the ETS-Lindgren *Product Information Bulletin* included with your shipment.

Maintenance of the Model 3147 Log Periodic Dipole Antenna is limited to external components such as cables or connectors. If you have any questions concerning maintenance, contact ETS-Lindgren Customer Service.

Maintenance Recommendations

If the Model 3147 is used outdoors, periodic removal of the antenna cable connection and cleaning of any corrosion may be needed to maintain accuracy of the measurements. An inspection to determine the need for cleaning should be made at least every six months. More frequent inspection may be needed depending on the atmosphere and the environment in which the antenna is used.

Annual Calibration

See the *Product Information Bulletin* included with your shipment for information on ETS-Lindgren calibration services.

Service Procedures

For the steps to return a system or system component to ETS-Lindgren for service, see the *Product Information Bulletin* included with your shipment.

This page intentionally left blank.

3.0 Specifications

Electrical Specifications

Frequency Range:	200 MHz–5 GHz
VSWR:	Average: 1.25:1 Maximum: 1.7:1
Impedance:	50 Ω
Maximum Continuous Input Power:	80 W at 1 GHz 40 W at 5 GHz
Maximum Peak Input Power:	100 W at 1 GHz 50 W at 5 GHz
Connector:	Precision N female

Physical Specifications

Height:	7.62 cm 3.0 in
Width:	88 cm 34.65 in
Depth:	97 cm 38.19 in
Weight:	4.25 kg 9.36 lb

This page intentionally left blank.

4.0 Mounting Instructions

CAUTION

Before connecting any components, follow the safety information in the ETS-Lindgren *Product Information Bulletin* included with your shipment.

CAUTION

The Model 3147 is a precision measurement device. Handle with care.

Using Included Mounting Adapters

The Model 3147 Log Periodic Dipole Antenna ships with these mounting adapters:

- **100989 Polarizing Mounting Adapter with 7/8–14 thread receptacle**

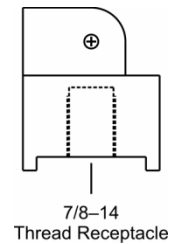

If you need to convert the polarizing adapter to a 1/4–20 receptacle, insert the 1/4–20 thread insert into the polarizing adapter



- **105861 1/4–20 Thread Insert**



To attach the included adapters to the Model 3147:

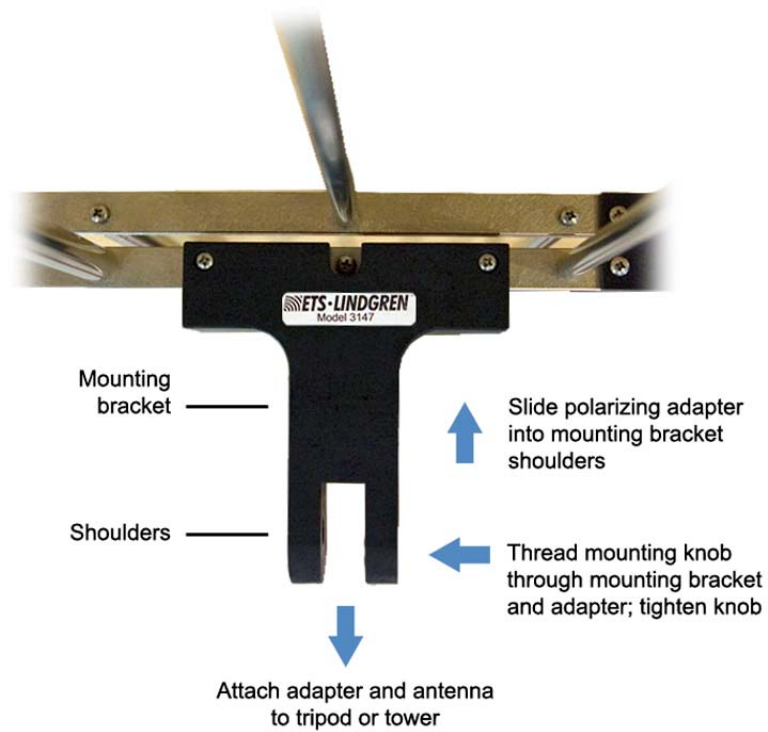

1. If required, insert the 1/4–20 thread insert into the polarizing adapter.
2. Remove the mounting knob from the mounting bracket on the antenna.
3. Slide the polarizing adapter into the mounting bracket by placing the polarizing adapter placed between the shoulders of the mounting bracket.

4. Thread the mounting knob through the mounting bracket, then through the polarizing adapter, and finally through the hex nut.



Do not cross thread or permanent damage to the adapter could occur.

5. Tighten the mounting knob to secure the antenna.
6. Attach the polarizing adapter and antenna to tripod or tower, as required.

Additional Mounting Options

4-TR MOUNTING OPTIONS

Following are additional options for mounting the Model 3147 onto an ETS-Lindgren 4-TR tripod. Contact the ETS-Lindgren Sales Department for information on ordering optional mounting hardware.

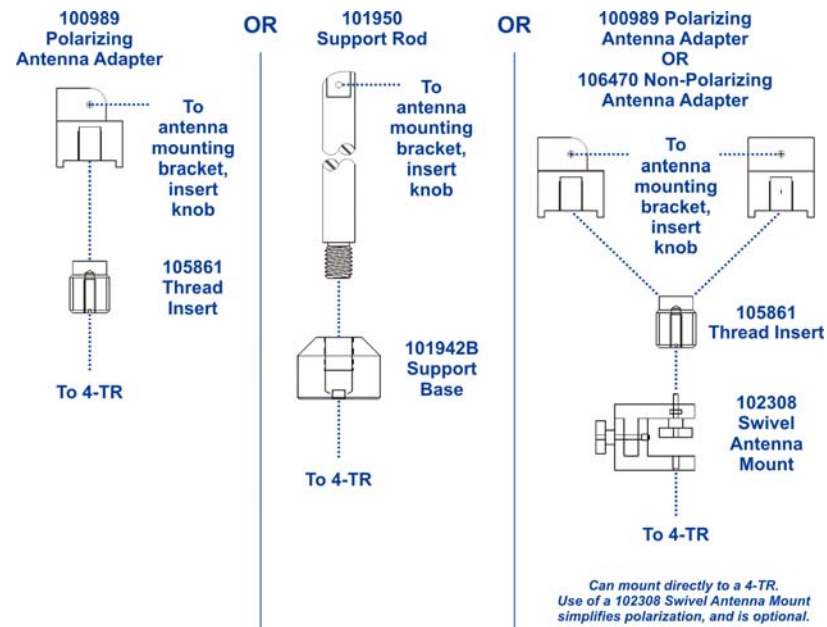

7-TR AND MAST MOUNTING OPTIONS

Following are options for mounting the Model 3147 onto an ETS-Lindgren 7-TR Tripod or mast. Contact the ETS-Lindgren Sales Department for information on ordering optional mounting hardware.



Mast refers to 2070 Series, 2075, and 2175 Antenna Towers.

7-TR refers to 109042, 108983, and 108507 booms:

- *109042 boom*—Straight boom; for general antenna mounting on a 7-TR
- *108983 boom*—Offset boom; for general antenna mounting on a 7-TR with pneumatic or manual polarization; can also be used to mount stinger-type antennas

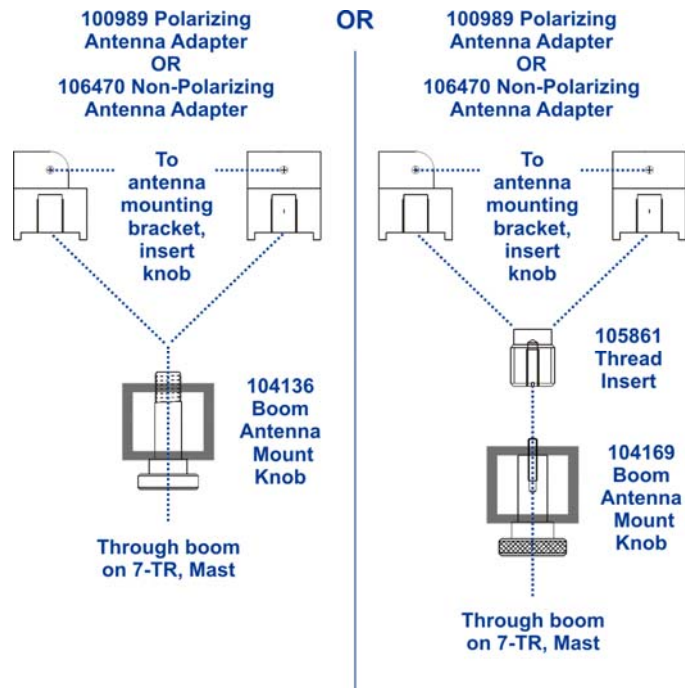

2x2 BOOM MOUNTING OPTIONS

Following are additional options for mounting the Model 3147 onto a 2x2 boom.
Contact the ETS-Lindgren Sales Department for information on ordering optional mounting hardware.



2x2 boom refers to a typical 2-inch by 2-inch boom.

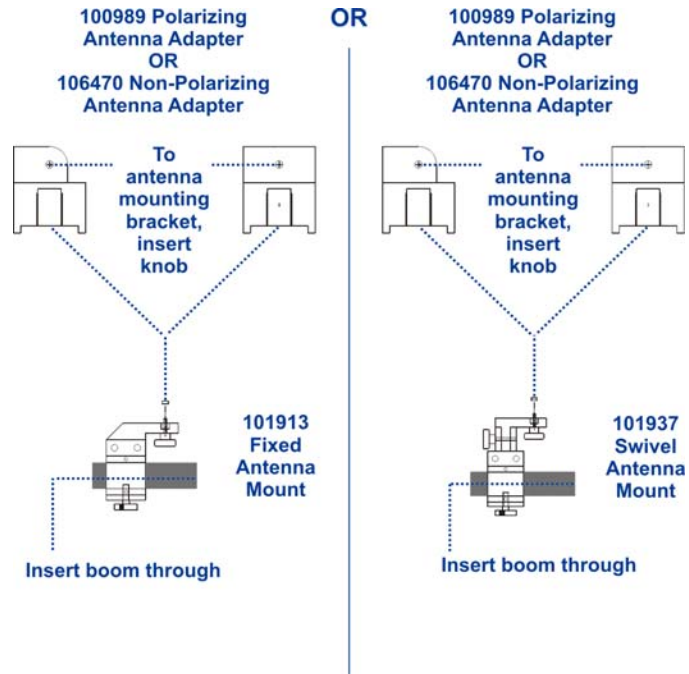

This page intentionally left blank.

5.0 Operation

CAUTION

Before connecting any components, follow the safety information in the ETS-Lindgren *Product Information Bulletin* included with your shipment.

Model 3147 Assembly Instructions



A variety of mounting options are available for the Model 3147. For information, see *Mounting Instructions* on page 15.

To attach the support rod to the base of the Model 3147 Log Periodic Dipole Antenna:

1. Remove the clamping screw from the mount on the antenna.
2. Insert the support rod.
3. Replace the screw.
4. Place the support rod and base onto a tripod, and then tighten the 1/4–20 screw in the bottom of the base.
5. Remove the red connector cover from the precision N connector.
6. Attach a cable to the precision N connector and to the input of a measuring device.

Model 3147 Use

The Model 3147 may be used for either reception or transmission of electromagnetic energy. The primary design goal is the efficient reception of signals from 200 MHz to 5 GHz for electromagnetic compatibility testing to commercial standards such as CFR 47 Part 15 of the FCC Rules and Regulations. Typical performance data is provided beginning on page 23 to assist with use. Methods of use for radiated emissions measurement are described on page 31.

This page intentionally left blank.

6.0 Typical Data

Following are typical measurements for the Model 3147 Log Periodic Dipole Antenna.

Typical VSWR for Model 3147



This is a plot of the VSWR showing the antenna with and without a radome. The effect of the radome on the electromagnetic performance of the antenna is minimal.

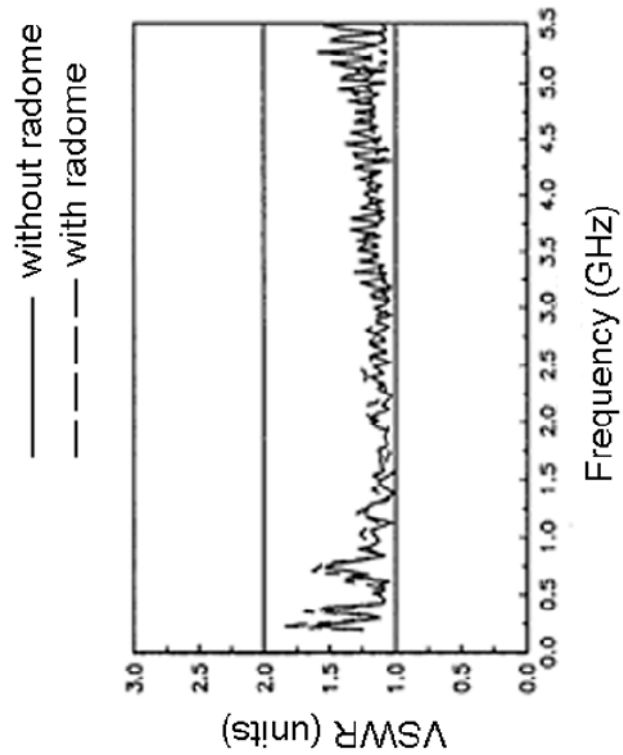

Typical Antenna Factor and Gain for Model 3147

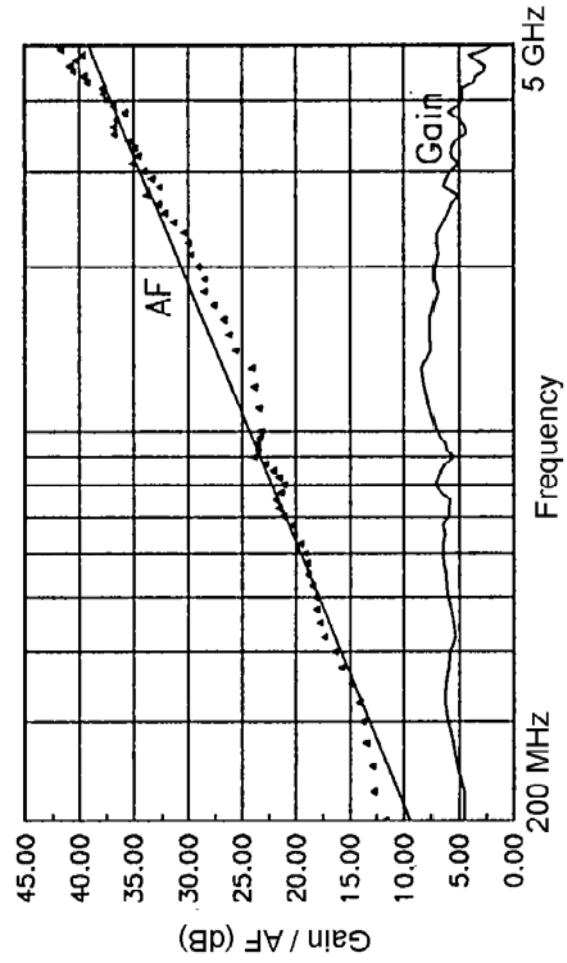

The antenna factor of the Model 3147 (triangles) measured at the distance of three meters as per ANSI C63.5. The standard states that *the spacing R between log-periodic array antennas is measured from the projection onto the ground plane of the midpoint of the longitudinal axis of each antenna*. This midpoint has been marked on the radome and labeled *Reference Point* Per ANSI C63.5. The line shown in the figure is a linear fit to the antenna factor data. The second curve shows the gain of the antenna as computed from the antenna factor by:

$$G(\text{dB}) = 20 \log(F_{\text{MHz}}) - 29.79 - AF_{\text{dB(m}^{-1}\text{)}}$$

Beamwidth for Horizontally and Vertically Polarized Model 3147



The beamwidth charts show the 3-dB and 10-dB power beamwidth as determined from the antenna patterns taken for both horizontal and vertical polarizations.

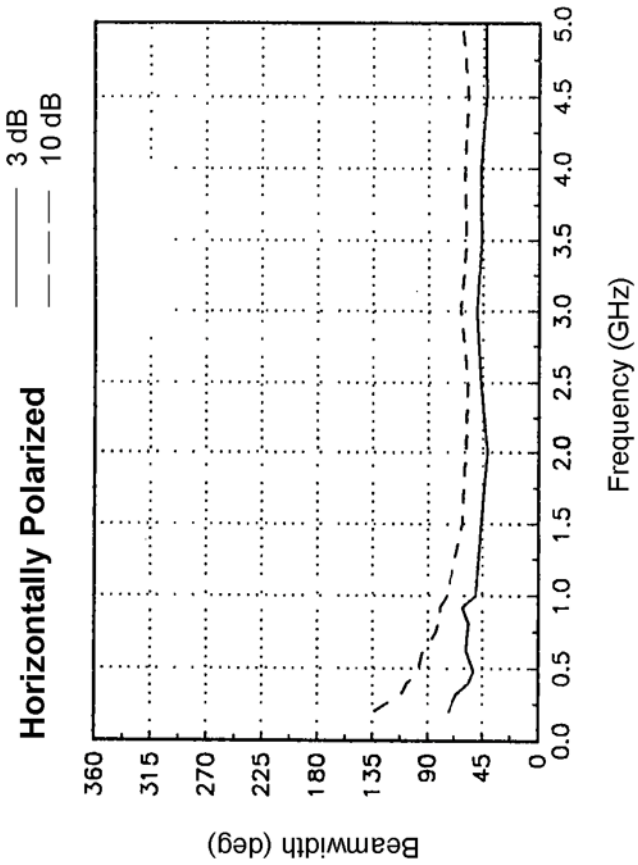

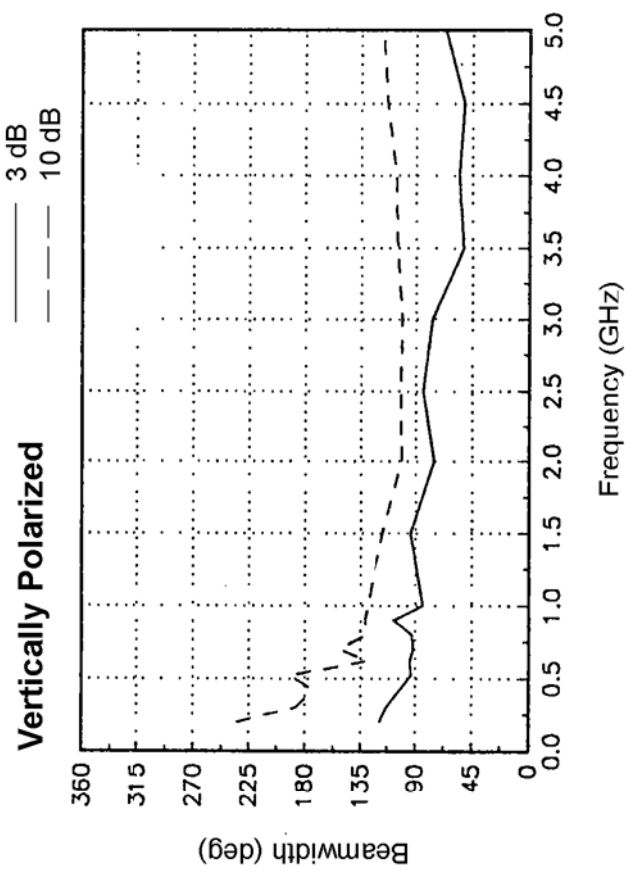

Front-to-Back Ratio for Model 3147



The front-to-back ratio is representative of how well the antenna propagates energy in the end fire direction. The measurement is made by first positioning two identical Model 3147 antennas face-to-face at a 2-meter height and a 3-meter distance. A signal is transmitted through one antenna and received with the other. The transmitting antenna is then rotated 180° in azimuth so that the back is pointed towards the receiving antenna. The difference between the two measurements is taken as the front-to-back ratio.

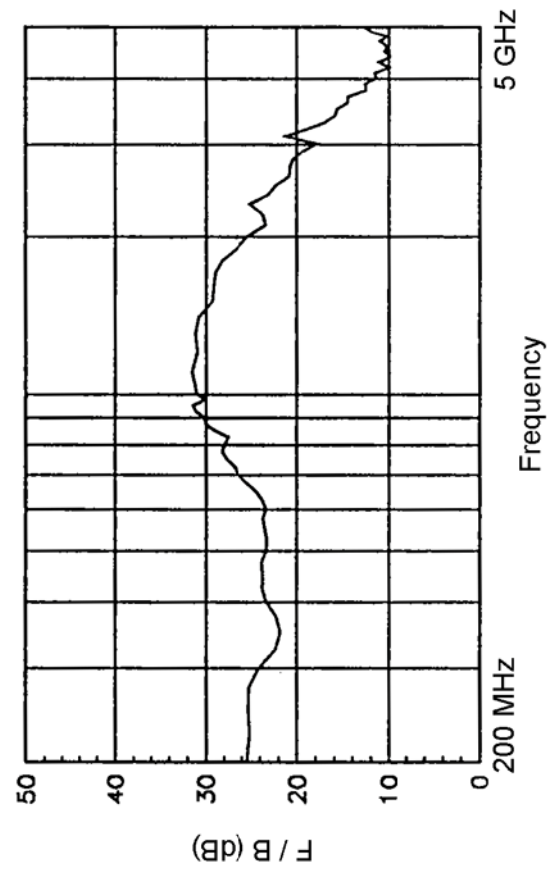

Cable Attenuation (dB) at 20°C for 6-M Cable

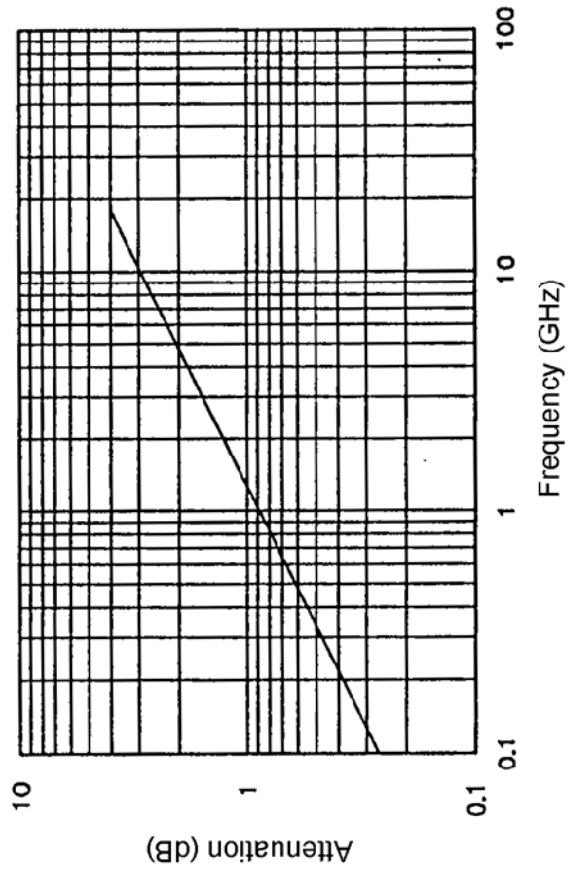

Typical Antenna Pattern for 200 MHz and 300 MHz

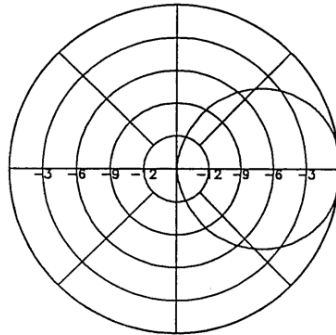

200 MHz, Horizontal Polarization

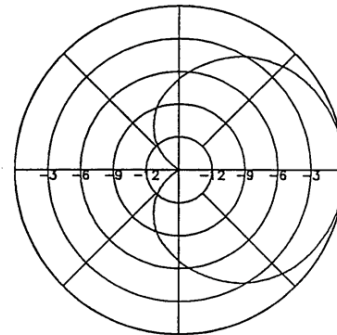

200 MHz, Vertical Polarization

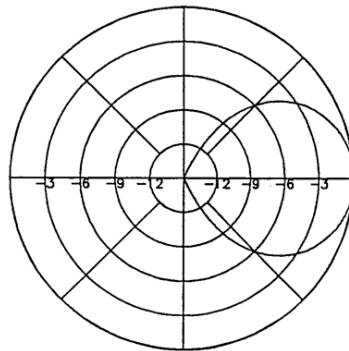

300 MHz, Horizontal Polarization

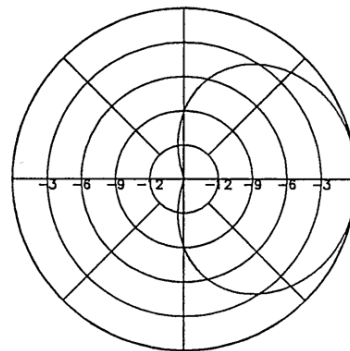

300 MHz, Vertical Polarization

This shows a sample antenna pattern taken at selected frequencies of 200 MHz and 300 MHz. Additional antenna patterns are located in *Appendix A* on page 41. These patterns were measured indoors using a separation distance of 1 meter to 1.5 meters between the transmit antenna and the receive antenna.

The antenna patterns in *Appendix A* and the beamwidths on page 26 are useful in determining the size of the Equipment Under Test (EUT) that can be measured with the Model 3147 at a specified distance.

7.0 Radiated Emissions Measurement

CAUTION

Before connecting any components, follow the safety information in the ETS-Lindgren *Product Information Bulletin* included with your shipment.

Ambient field strength values are measured as follows:

1. Install the antenna where measured field strength values are desired.
2. Select the desired orientation of the antenna, both boresite direction and polarization.
3. Connect the antenna output connector to the input of the receiving system using a coaxial cable. These antennas are calibrated for receiving systems having 50-Ω input impedance. Other values of receiving system input impedance will require correction for the differences in input impedance.
4. Select the desired frequency of measurement on the receiving system.
5. Measure the RF voltage, V_a , referenced to the input port of the receiving system. The units of the measurement should be in dB referenced to 1 microvolt, dB(μV). If the units of measurement as displayed by the receiver are not dB(μV), for example, in millivolts, they should be converted to microvolts and then converted to dB(μV) by:

$$V_a = 20 \times \log_{10} (\text{RF voltage in microvolts})$$

$$V_a = 20 \times \log_{10} V_d$$

6. To determine the field strength at the frequency of the observation, add the voltage reading from the receiving system in dB(μV) to the value given by the antenna factor chart at that frequency in dB (m⁻¹):

$$\text{RF Voltage, dB}(\mu\text{V}) + \text{Antenna Factor dB (m}^{-1}\text{)} = \text{Field Strength dB } (\mu\text{V/m)}$$

$$E_a = V_a + AF$$

If a long coaxial cable is used between the antenna and the receiving device, or the frequency of the observation is more than several tens of MHz, the losses in the coaxial cable, A_e , must be included in the computation. In this case the computation is:

$$\text{RF Voltage, dB}(\mu\text{V}) + \text{Cable Loss, dB} + \text{Antenna Factor, dB (m}^{-1}\text{)} = \text{Field Strength dB } (\mu\text{V/m})$$

$$E_a = V_a + AF + A_e$$

Conversion Factors

Following are some useful conversion formulas.

$\text{dBm} = \text{dB}(\mu\text{V}) - 107$
$\text{dB}(\text{mW/m}^2) = \text{dB}(\mu\text{V/m}) - 115.8$
$\text{dB}(\mu\text{V/m}) = \text{dB}(\mu\text{V}) + AF$
$\frac{\text{dB}(\mu\text{V/m}) - 120}{20}$ $\text{V/m} = 10$
$\text{dB}(\mu\text{A/m}) = \text{dB}(\mu\text{V/m}) - 51.5$
$\frac{\text{dB}(\mu\text{A/m}) - 120}{20}$ $\text{A/m} = 10$
$\text{dB}(\text{W/m}^2) = 10 \log(\text{V/m A/m})$
$\text{dB}(\text{mW/m}^2) = \text{dB}(\text{W/m}^2) + 30$
$\text{dB}(\text{pT}) = \text{dB}(\mu\text{A/m}) + 2.0$

The constants that appear in the above equations are obtained as follows:

In the first equation, the power is related to the voltage via the system impedance as:

$$P = \frac{V^2}{R}$$

In a 50-Ω system, the above equation becomes:

$$10 \log_{10} P = 20 \log_{10} V - 10 \log_{10}(50)$$

Converting from dB to dBm for power and from dB(V) to dB(μV) for voltage, the added constant becomes:

$$30 - 120 - 10 \log_{10}(50) = -107$$

The constant in the second equation is obtained by considering the pointing vector which relates the power density in (W/m^2) to the electric field density in (V/m) by:

$$P = \frac{|E|^2}{\eta}$$

Where η is the free space characteristic impedance equal to $120\pi \Omega$.

Transforming the previous equation to decibels and using the appropriate conversion factors to convert dB(W/m^2) to dB(mW/m^2) for power density and dB(V/m) to dB($\mu V/m$) for the electric field, the constant becomes:

$$30 - 120 - 10 \log_{10}(120\pi) = -115.8$$

For the constant in the fifth equation, the magnetic field density is related to the electric field density via the characteristic impedance of free space. When the transformation is made to decibels, the constant becomes:

$$20 \log_{10}(120\pi) = 51.5$$

In the last equation, the magnetic flux density \mathbf{B} in (T) is related to the magnetic field density \mathbf{H} in (A/m) the permeability of the medium in (H/m). For free space the permeability is $\mu_0 = 4\pi \times 10^{-7}$ H/m. Converting from (T) to (pT) and from (A/m) to ($\mu A/M$) and taking the log, the constant becomes:

$$240 - 120 + 20 \log_{10}(4\pi \times 10^{-7}) = 2.0$$

This page intentionally left blank.

8.0 Power Requirements

The Model 3147 Log Periodic Dipole Antenna may also be used as a transmitting antenna. The power input requirements for a desired electric field strength level are provided in the *Power Requirements* table on page 36. The power is computed according to the transmission equation:

$$\text{Power transmitted} = \frac{(\text{field strength})^2(\text{distance in meters})^2}{(30 \times \text{Numeric Gain})}$$

$$P_t = \frac{|E|^2 R^2}{30 g}$$

In the *Power Requirements* table on page 36, **R is 3 meters**. It is measured from the center of the antenna as per ANSI C63.5. The power limitation is 80 Watts maximum continuous power for frequencies below 1 GHz and 40 Watts maximum continuous power above 1 GHz. An asterisk indicates where the power required to generate a certain field level exceeded the maximum continuous power rating. As an example, to generate a 20 V/m electric field at 1 GHz, the measured antenna factor is 23.2 dB(m⁻¹). The gain in dB is computed using:

$$G(\text{dB}) = 20 \log_{10}(F_{\text{MHz}}) - 29.79 - \text{AF}$$

$$G(\text{dB}) = 20 \log_{10}(1000) - 29.79 - 23.2 = 7.0$$

Converting this value to obtain numeric gain:

$$g = 10^{0.7} = 5.0$$

Applying the formula for the power transmitted:

$$P_t = \frac{|E|^2 R^2}{30 g} = \frac{(20^2)(3^2)}{30(5)} = 24$$

Power Requirements Table

Power requirements for a given field strength computed using typical antenna calibration factors at 3-meter spacing.

80 WATTS CONTINUOUS POWER

Freq (MHz)	AF	Gain (dB)	Gain (num)	Field Strength (E)		
				1 V/m	10 V/m	20 V/m
200	11.7	4.5	2.8	0.106	10.6	42.6
225	12.8	4.5	2.8	0.106	10.6	42.6
250	12.9	5.2	3.3	0.091	9.1	36.2
275	13.5	5.5	3.5	0.085	8.5	33.8
300	13.8	6.0	4.0	0.075	7.5	30.1
325	14.1	6.3	4.3	0.070	7.0	28.1
350	14.9	6.2	4.2	0.072	7.2	28.8
375	15.8	5.9	3.9	0.077	7.7	30.8
400	16.4	5.8	3.8	0.079	7.9	31.6
425	17.4	5.3	3.4	0.089	8.8	35.4
450	17.8	5.5	3.5	0.085	8.5	33.8
475	18.1	5.7	3.7	0.081	8.1	32.3
500	18.2	6.0	4.0	0.075	7.5	30.1
525	18.5	6.1	4.1	0.074	7.4	29.4
550	18.9	6.2	4.2	0.072	7.2	28.8
575	19.0	6.4	4.4	0.069	6.9	27.5
600	19.2	6.5	4.5	0.067	6.7	26.9

Freq (MHz)	AF	Gain (dB)	Gain (num)	Field Strength (E)		
				1 V/m	10 V/m	20 V/m
625	19.6	6.5	4.5	0.067	6.7	26.9
650	20.2	6.3	4.3	0.070	7.0	28.1
675	20.3	6.5	4.5	0.067	6.7	26.9
700	21.2	5.9	3.9	0.077	7.7	30.8
725	21.6	5.9	3.9	0.077	7.7	30.8
750	21.9	5.8	3.8	0.079	7.9	31.6
775	21.4	6.6	4.6	0.066	6.6	26.3
800	21.1	7.2	5.2	0.057	5.7	22.9
825	21.6	6.9	4.9	0.061	6.1	24.5
850	22.1	6.7	4.7	0.064	6.4	25.6
875	22.8	6.3	4.3	0.070	7.0	28.1
900	23.9	5.4	3.5	0.087	8.6	34.6
925	23.5	6.1	4.1	0.074	7.4	29.4
950	23.6	6.2	4.2	0.072	7.2	28.8
975	23.3	6.7	4.7	0.064	6.4	25.6
1000	23.2	7.0	5.0	0.060	6.0	23.9

40 WATTS CONTINUOUS POWER

Freq (MHz)	AF	Gain (dB)	Gain (num)	Field Strength (E)		
				1 V/m	10 V/m	20 V/m
1000	23.2	7.0	5.0	0.060	6.0	23.9
1100	23.4	7.6	5.8	0.052	5.2	20.8
1200	23.8	8.1	6.5	0.046	4.6	18.6
1300	24.1	8.4	6.9	0.043	4.3	17.3
1400	25.6	7.5	5.6	0.053	5.3	21.3
1500	26.2	7.6	5.8	0.052	5.2	20.8
1600	26.7	7.6	5.8	0.052	5.2	20.8
1700	27.6	7.3	5.4	0.056	5.6	22.3
1800	28.5	6.9	4.9	0.061	6.1	24.5
1900	28.5	7.3	5.4	0.056	5.6	22.3
2000	29.1	7.2	5.2	0.057	5.7	22.9
2100	29.8	6.9	4.9	0.061	6.1	24.5
2200	30.0	7.1	5.1	0.058	5.8	23.4
2300	30.5	7.0	5.0	0.060	6.0	23.9
2400	31.4	6.5	4.5	0.067	6.7	26.9
2500	32.2	6.0	4.0	0.075	7.5	30.1
2600	32.8	5.7	3.7	0.081	8.0	32.3
2700	33.8	5.0	3.2	0.095	9.5	37.9
2800	32.7	6.5	4.5	0.067	6.7	26.9
2900	33.4	6.1	4.1	0.074	7.4	29.4

Freq (MHz)	AF	Gain (dB)	Gain (num)	Field Strength (E)		
				1 V/m	10 V/m	20 V/m
3000	34.0	5.8	3.8	0.079	7.9	31.6
3100	35.1	5.0	3.2	0.095	9.5	37.9
3200	34.6	5.7	3.7	0.081	8.1	32.3
3300	34.9	5.7	3.7	0.081	8.1	32.3
3400	35.5	5.3	3.4	0.089	8.8	35.4
3500	36.8	4.3	2.7	0.111	11.1	44.6
3600	36.9	4.4	2.8	0.109	10.9	43.6
3700	36.6	5.0	3.2	0.095	9.5	37.9
3800	35.8	6.0	4.0	0.075	7.5	30.1
3900	36.9	5.2	3.3	0.091	9.1	36.2
4000	37.6	4.7	3.0	0.102	10.2	40.7
4100	37.9	4.6	2.9	0.104	10.4	*
4200	37.9	4.8	3.0	0.099	9.9	*
4300	39.3	3.6	2.3	0.131	13.1	*
4400	39.6	3.5	2.2	0.134	13.4	*
4500	40.6	2.7	1.9	0.161	16.1	*
4600	40.9	2.6	1.8	0.165	16.5	*
4700	40.3	3.4	2.2	0.137	13.7	*
4800	39.7	4.1	2.6	0.117	11.7	*
4900	41.7	2.4	1.7	0.173	17.3	*
5000	42.0	2.1	1.6	0.185	18.5	*

This page intentionally left blank.

Appendix A: Typical Antenna Patterns

400 MHz

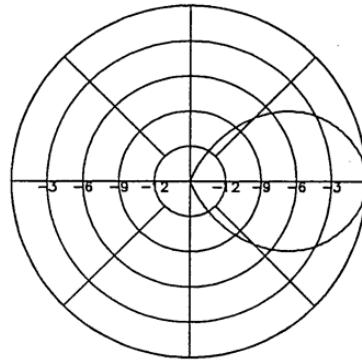

400 MHz, Horizontal Polarization

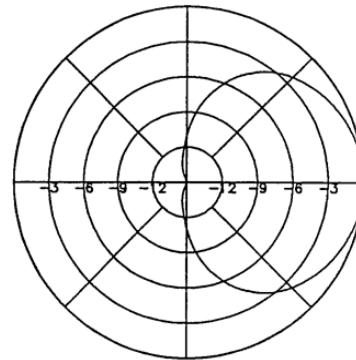

400 MHz, Vertical Polarization

500 MHz

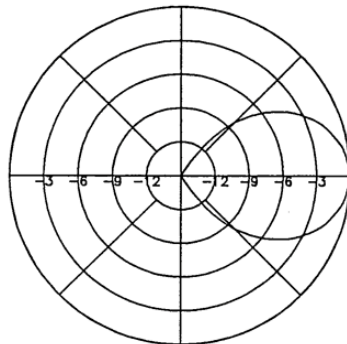

500 MHz, Horizontal Polarization

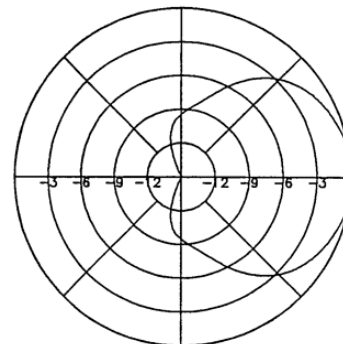

500 MHz, Vertical Polarization

600 MHz

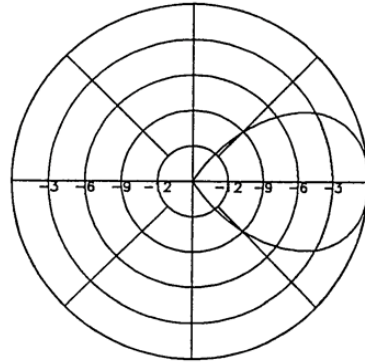

600 MHz, Horizontal Polarization

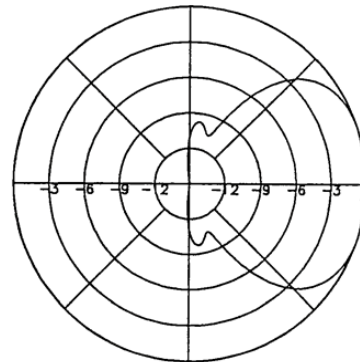

600 MHz, Vertical Polarization

700 MHz

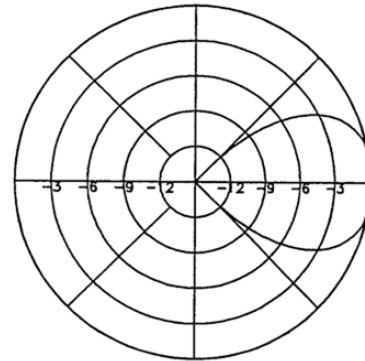

700 MHz, Horizontal Polarization

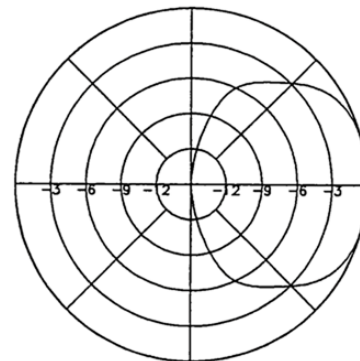

700 MHz, Vertical Polarization

800 MHz

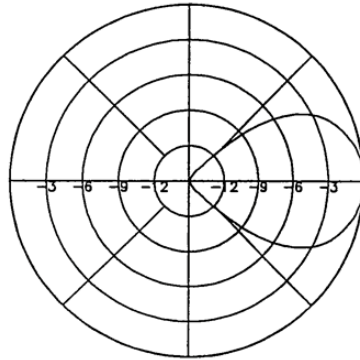

800 MHz, Horizontal Polarization

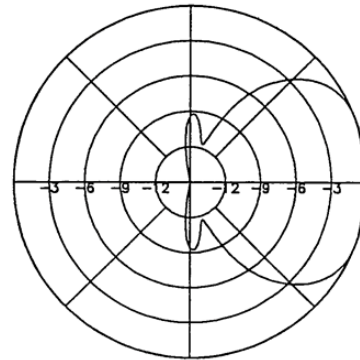

800 MHz, Vertical Polarization

900 MHz

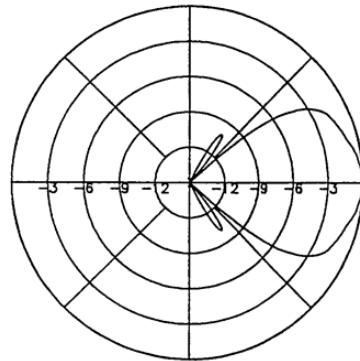

900 MHz, Horizontal Polarization

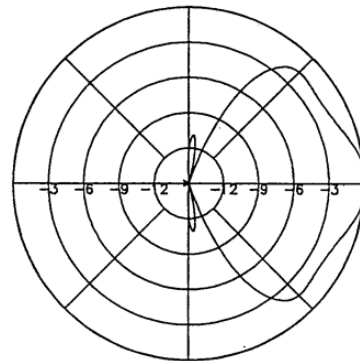

900 MHz, Vertical Polarization

1.0 GHz

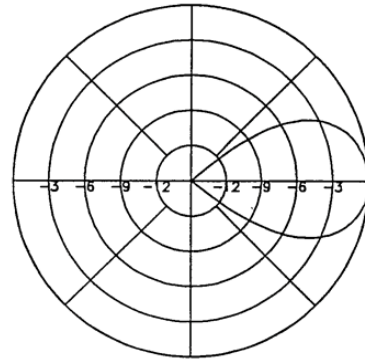

1.0 GHz, Horizontal Polarization

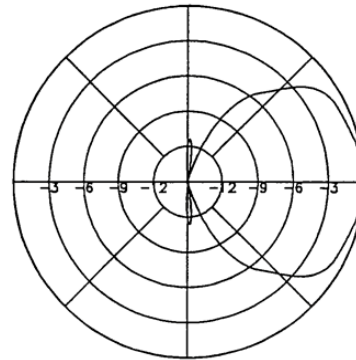

1.0 GHz, Vertical Polarization

1.5 GHz

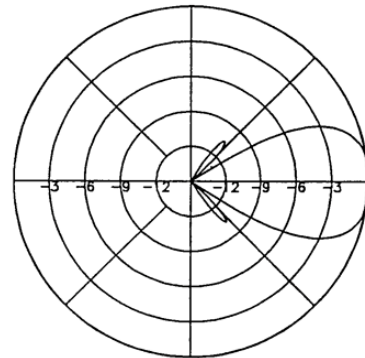

1.5 GHz, Horizontal Polarization

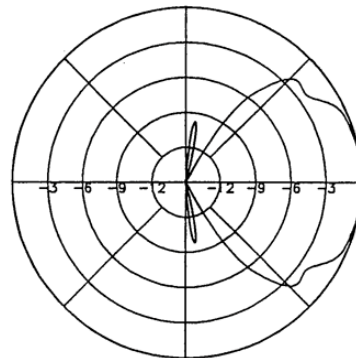

1.5 GHz, Vertical Polarization

2.0 GHz

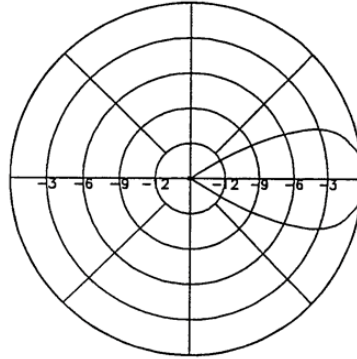

2.0 GHz, Horizontal Polarization

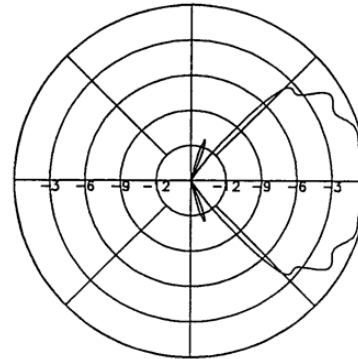

2.0 GHz, Vertical Polarization

2.5 GHz

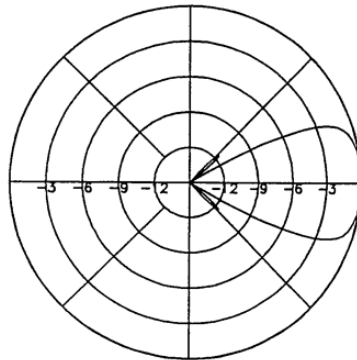

2.5 GHz, Horizontal Polarization

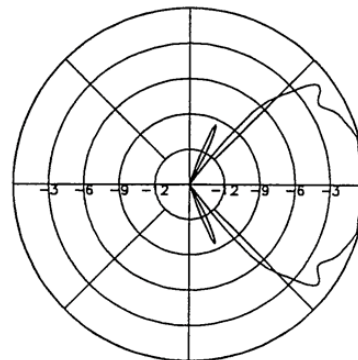

2.5 GHz, Vertical Polarization

3.0 GHz

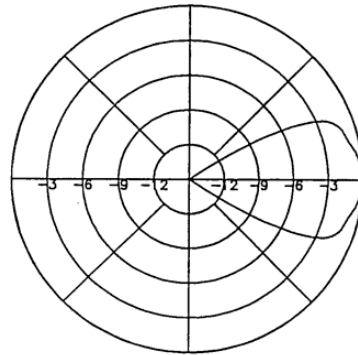

3.0 GHz, Horizontal Polarization

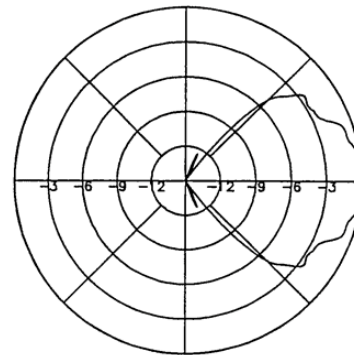

3.0 GHz, Vertical Polarization

3.5 GHz

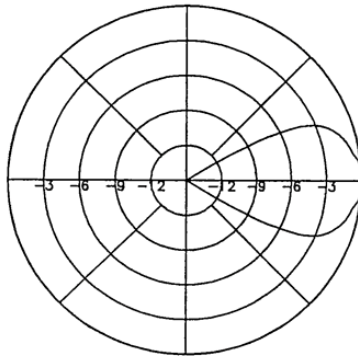

3.5 GHz, Horizontal Polarization

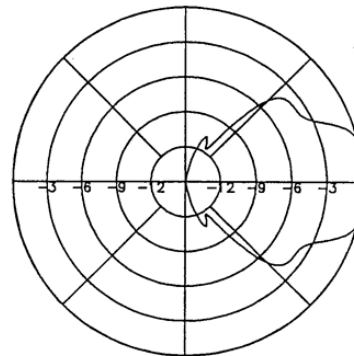

3.5 GHz, Vertical Polarization

4.0 GHz

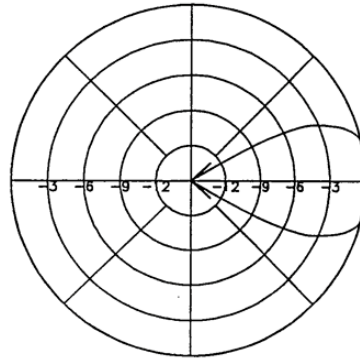

4.0 GHz, Horizontal Polarization

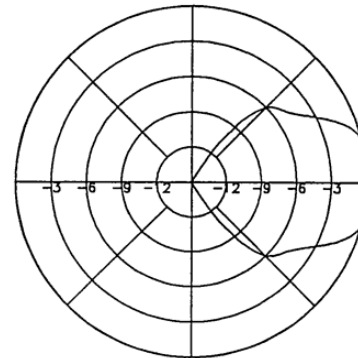

4.0 GHz, Vertical Polarization

4.5 GHz

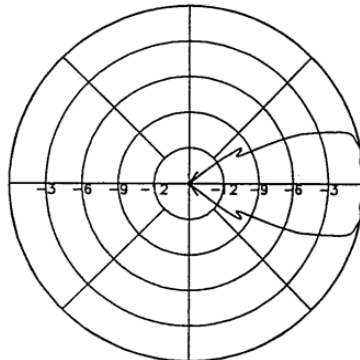

4.5 GHz, Horizontal Polarization

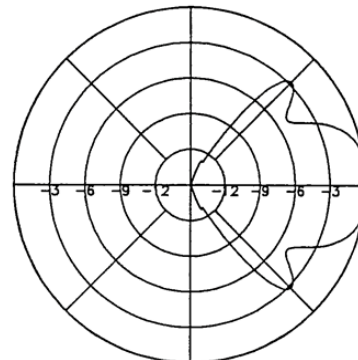

4.5 GHz, Vertical Polarization

5.0 GHz

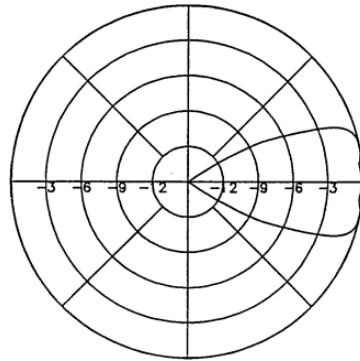

5.0 GHz, Horizontal Polarization

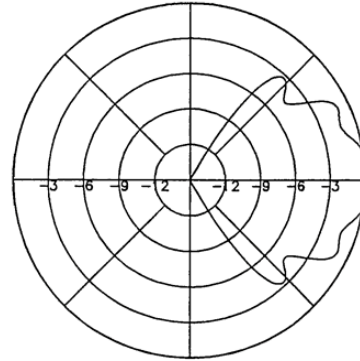

5.0 GHz, Vertical Polarization

Appendix B: Warranty



See the *Product Information Bulletin* included with your shipment for the complete ETS-Lindgren warranty for your Model 3147 Log Periodic Dipole Antenna.

DURATION OF WARRANTIES FOR MODEL 3147

All product warranties, except the warranty of title, and all remedies for warranty failures are limited to two years.

Product Warranted	Duration of Warranty Period
Model 3147 Log Periodic Dipole Antenna	2 Years