

EMSwitch™

RF Switch Plug-In Card

User Manual



Model 7001-001

Model 7001-003

Model 7001-002

(not all models shown)

ETS-Lindgren Inc. reserves the right to make changes to any product described herein in order to improve function, design, or for any other reason. Nothing contained herein shall constitute ETS-Lindgren Inc. assuming any liability whatsoever arising out of the application or use of any product or circuit described herein. ETS-Lindgren Inc. does not convey any license under its patent rights or the rights of others.

© Copyright 2014–2020 by ETS-Lindgren Inc. All Rights Reserved. No part of this document may be copied by any means without written permission from ETS-Lindgren Inc.

Trademarks used in this document: The *ETS-Lindgren* logo is a registered trademark, and *EMCenter*, *EMSwitch*, *TILE!*, and *EMQuest* are trademarks of ETS-Lindgren Inc.

Revision Record

MANUAL, EMSWITCH | Part #399343, Rev. F

Revision	Description	Date
A	Initial Release	June, 2014
B	Updated EMCenter models	June, 2014
C	Added Model 7001-005; updated <i>EMSwitch Remote Relay</i>	July, 2015
D	Updated Typical Data with main specifications	March, 2016
E	Updated physical specifications	December, 2016
F	Corrected specs on page 39-40; added replacement part information	May, 2020

Table of Contents

Notes, Cautions, and Warnings	v
Safety Information.....	v
1.0 Introduction	7
EMSwitch Models	8
18 GHz Models	8
40 GHz Models	8
12.4 GHz Model.....	8
EMCenter Modular RF Platform (Required)	9
EMSwitch Remote Relay (Optional)	10
Standard Configuration.....	10
Replacement Parts	10
Optional Items.....	10
2.0 Maintenance	11
Maintenance of Fiber Optics (If Used).....	11
Service Procedures	12
Contacting ETS-Lindgren	12
Sending a Component for Service.....	12
3.0 Specifications	13
Performance Specifications	13
Lifetime Relays	14
Electrical Specifications	14
Physical Specifications	15
Environmental Specifications.....	15
4.0 EMSwitch Card Controls and Connectors	17
Relay Number and Contact Definitions.....	17
Interlock	18
5.0 EMSwitch Plug-In Card Installation	19
Plug-In Card Installation	19
6.0 EMSwitch Remote Relay	21
Front and Back Panel Connectors.....	21
Relays.....	21

Readback Function	22
Set Up RS-232 Address	23
7.0 Operation	25
Powering On and Off EMCenter	25
Power On	25
Power Off	27
Manual Control of EMSwitch	28
Safety Interlock Relay	29
Relay Errors	30
8.0 EMSwitch Command Set	31
Examples	31
Example 1: Request Software Version	31
Example 2: Set Internal Relay	31
Example 3: Set External Relay	32
Remote Commands	33
Command Set—Common to All EMSwitch Models	33
Command Set—Model-Specific: 7001-001, 7001-002, 7001-011, 7001-012, 7001-021	34
Command Set—Model-Specific: 7001-003, 7001-005, 7001-013, 7001-015	36
Error Codes	37
9.0 Typical Data	39
Specifications of plug-in cards with SMA connectors	39
Specifications of plug-in cards with 2.92 mm connectors	40
Power Handling	41
VSWR	43
Appendix A: Warranty	45
Scope and Duration of Warranties	45
Warranty Exclusions	46
Buyer's Remedies	47
Appendix B: EC Declaration of Conformity	49

Notes, Cautions, and Warnings



Note: Denotes helpful information intended to provide tips for better use of the product.



Caution: Denotes a hazard. Failure to follow instructions could result in minor personal injury and/or property damage. Included text gives proper procedures.



Warning: Denotes a hazard. Failure to follow instructions could result in SEVERE personal injury and/or property damage. Included text gives proper procedures.

Safety Information



High Voltage: Indicates presence of hazardous voltage. Unsafe practice could result in severe personal injury or death.

OR



Protective Earth Ground (Safety Ground): Indicates protective earth terminal. You should provide uninterruptible safety earth ground from the main power source to the product input wiring terminals, power cord, or supplied power cord set.



Laser Warning: Denotes a laser (class 1M) is part of the operating system of the device.

This page intentionally left blank.

1.0 Introduction

The ETS-Lindgren EMSwitch™ RF Switch Plug-in Card is a general purpose multi-channel switch matrix used to switch the RF path of equipment for RF measurement applications, including immunity, emissions, and wireless measurements. EMSwitch is designed for use with the EMCenter™ Modular RF Platform; for more information about EMCenter, see page 9.



The first relay of each EMSwitch card can be used as a standard relay or as a safety interlock relay. When being used as a safety interlock relay, the RF input signal to the RF amplifier can be switched off to prevent personnel from being subjected to high RF fields. The RF interlock input can, for example, be connected to a switch mounted on the entrance door of the test chamber.

EMSwitch is fully supported by ETS-Lindgren TILE!™ (Totally Integrated Laboratory Environment), ETS-Lindgren EMQuest™ Data Acquisition and Analysis Software, and other test automation software packages. Contact ETS-Lindgren for additional information.

EMSwitch Models

EMSwitch cards switch RF signals up to 40 GHz, depending on the model, with powers up to 240 W (3 GHz) directly or any RF power switches indirectly. When high power RF amplifiers are used in a test system, the EMSwitch card can be connected to an optional EMSwitch Remote Relay Module. For more information, see page 10.

The following models of the EMSwitch card are available:



Note: The EMCenter supports any installed combination of EMSwitch cards.

18 GHz MODELS

- **7001-001**—Two SPDT coaxial relays
- **7001-002**—Four SPDT coaxial relays
- **7001-003**—Two SP6T coaxial relays
- **7001-005**—One SP6T coaxial relay

40 GHz MODELS

- **7001-011**—Two SPDT coaxial relays
- **7001-012**—Four SPDT coaxial relays
- **7001-013**—Two SP6T coaxial relays
- **7001-015**—One SP6T coaxial relay

12.4 GHz MODEL

- **7001-021**—One SPDT coaxial relay

EMCenter Modular RF Platform (Required)

The EMCenter Modular RF Platform is required for operation, and is sold separately.



Front Panel



Back Panel

The EMCenter may be controlled from a computer using these software products:

- ETS-Lindgren TILE!™ (Totally Integrated Laboratory Environment)
- ETS-Lindgren EMQuest™ Data Acquisition and Analysis Software
- Other test automation software

Contact ETS-Lindgren for ordering information.

EMSwitch Remote Relay (Optional)

The Model 7001-004 Remote Relay is an optional 19-inch 2U rack-mountable device to control up to four external (coax) relays using the touchscreen on the EMCenter or with one of these software products:

- ETS-Lindgren TILE!™ (Totally Integrated Laboratory Environment)
- ETS-Lindgren EMQuest™ Data Acquisition and Analysis Software
- Other test automation software

It has an internal power supply to power 12 VDC/28 VDC relays. For more information on the Remote Relay, see page 21.

Standard Configuration

- EMSwitch™ RF Switch Plug-in Card
- Interlock



Note: A 7000-xxx series EMCenter Modular RF Platform is required for operation, and is sold separately. Contact ETS-Lindgren for ordering information.

Replacement Parts

Replacement Part Description	Part Number
EMSwitch Interlock Plug (Binder 3-Way)	1608925

Optional Items

- Model 7001-004 Remote Relay

2.0 Maintenance



CAUTION: Before performing any maintenance, follow the information provided in *Safety Information* on page v.



WARNING: Maintenance of the EMSwitch card is limited to external components such as cables or connectors.



If you have any questions concerning maintenance, contact ETS-Lindgren Customer Service.

Maintenance of Fiber Optics (If Used)

Fiber optic connectors and cables can be damaged from airborne particles, humidity and moisture, oils from the human body, and debris from the connectors they plug into. Always handle connectors and cables with care, using the following guidelines.



CAUTION: Before performing any maintenance, disconnect the fiber optic cables from the unit and turn off power.

When disconnecting fiber optic cables, apply the included dust caps to the ends to maintain their integrity.

Before connecting fiber optic cables, clean the connector tips and in-line connectors.

Before attaching in-line connectors, clean them with moisture-free compressed air.

Failure to perform these tasks may result in damage to the fiber optic connectors or cables.

Service Procedures

CONTACTING ETS-LINDGREN



Note: Please see www.ets-lindgren.com for a list of ETS-Lindgren offices, including phone and email contact information.

SENDING A COMPONENT FOR SERVICE

1. Contact ETS-Lindgren Customer Service to obtain a Service Request Order (SRO).
2. Briefly describe the problem in writing. Give details regarding the observed symptom(s) or error codes, and whether the problem is constant or intermittent in nature. Please include the date(s), the service representative you spoke with, and the nature of the conversation. Include the serial number of the item being returned.
3. Package the system or component carefully. If possible, use the original packing materials or carrying case to return a system or system component to ETS-Lindgren.

3.0 Specifications



Note: The first switch on each EMSwitch card can be used as a true interlock switch.

Performance Specifications

	Number of Relays	Frequency Band	RF Switching Capacity
7001-001	2x SPDT	18 GHz	DC to 3 GHz: 240 W
7001-002	4x SPDT		3 to 8 GHz: 150 W
7001-003	2x SP6T		8 to 12.4 GHz: 120 W
7001-005	1xSP6T		12.4 to 18 GHz: 100 W
7001-011:	2x SPDT	40 GHz	DC to 6 GHz: 80 W
7001-012:	4x SPDT		6 to 12.4 GHz: 60 W
			12.4 to 18 GHz: 50 W
			18 to 26.5 GHz: 20 W
7001-013:	2x SP6T		26.5 to 40 GHz: 10 W
7001-015:	1xSP6T		DC to 6 GHz: 40 W
			6 to 12.4 GHz: 30 W
			12.4 to 18 GHz: 25 W
			18 to 26.5 GHz: 15 W
			26.5 to 40 GHz: 5 W
7001-021:	1x SPDT	12.4 GHz	DC to 1 GHz: 700 W
			1 to 2 GHz: 500 W
			2 to 3 GHz: 400 W
			3 to 8 GHz: 250 W
			8 to 12.4 GHz: 200 W

Lifetime Relays

- SPDT relays, SMA or 2.92mm (k): 10,000,000 cycles
- SP6T relay SMA: 5,000,000 cycles
- SP6T relay 2.92mm (k): 2,000,000 cycles
- N type relay: 1,000,000 cycles

Electrical Specifications

All EMSwitch™ RF Switch Plug-in Cards perform to the following electrical specifications:

- **Supply Voltage (Volts):** Through EMCenter



Note: The supply voltage for the Model 7001-004 Remote Relay is 230 VAC.

- **Power Consumption (Max Watts):** 30 W

Physical Specifications

	Exterior Dimension	RF Connectors	Remote Control External Relays
7001-001	One slot	SMA type	Fiber optic link
7001-002			
7001-003	Two slots	SMA type	
7001-005	Two slots		
7001-011	One slot	k type 2.92 mm	
7001-012			
7001-013	Two slots		
7001-015			
7001-021	One slot	N type	
7001-004 (H x W x D)	2U x 250 mm x 482.6 mm 2U x 9.8 in x 19 in	SMA type	

Environmental Specifications

All EMSwitch cards perform to the following environmental specifications:

- **Temperature Range:** 0°C to 40°C (32°F to 104°F)
- **Relative Humidity:** 10% to 90% (non-condensing)

This page intentionally left blank.

4.0 EMSwitch Card Controls and Connectors



CAUTION: Before placing into operation, follow the information provided in *Safety Information* on page v.

Relay Number and Contact Definitions

7001-001, 7001-002, 7001-011, 7001-012	
Relay number	Indicated below each relay, A to D.
Common	The center SMA connector of each relay, labeled COM .
Normally Open	The left SMA connector of each relay, labeled NO .
Normally Closed	The right SMA connector of each relay, labeled NC .
7001-003, 7001-005, 7001-013, 7001-015	
Common	The center connector; the six contacts are labeled J1 to J6.
7001-021	
Common	The center N connector, labeled COM .
Normally Open	The bottom N connector, labeled NO .
Normally Closed	The top N connector, labeled NC .

Interlock

The interlock connector provides two floating contacts which require shorting for the first relay.



If the interlock is open, the first relay will illuminate red on the EMCenter™ Modular RF Platform screen and the relay cannot be used. Use the supplied connector to wire to the emergency switch of your site. Connect the two pins of the connector.



Note: For replacement interlock connectors, contact ETS-Lindgren to order part number 1608925.

5.0 EMSwitch Plug-In Card Installation



CAUTION: Before connecting any components, follow the information provided in *Safety Information* on page v.



CAUTION: The EMSwitch card is designed to be used **ONLY** with the EMCenter. Do not use the card in combination with any other system.

Plug-In Card Installation



Note: Due to the width of the 7001-003, 7001-005, 7001-013, and 7001-015 EMSwitch cards, two consecutive empty slots are required for installation.

1. Determine in which empty slot in the EMCenter™ Modular RF Platform you want to install the EMSwitch™ RF Switch Plug-in Card. Looking at the back of the EMCenter, the slots are numbered 1 through 7 from left to right.
2. Remove the blank panel from the slot by removing the two screws at the top of the blank panel and the two screws at the bottom. Remove two consecutive blank panels if you are installing the 7001-003, 7001-005, 7001-013, or 7001-015 EMSwitch card.
3. Carefully insert the EMSwitch card into the slot(s) of the EMCenter. Tighten the four screws.
4. Turn on the EMCenter. The EMCenter will automatically detect the newly-installed EMSwitch card.
5. Depending on the test setup requirements, connect coaxial cables to the relay connections on the back panel of the EMCenter.
6. Connect the EMCenter to a personal computer using USB, RS-232, Ethernet, or IEEE (optional).
7. Plug the interlock into the connector on the back of the EMCenter.

The card installation is complete. You can control EMSwitch through the EMCenter touchscreen, with ETS-Lindgren TILE![™] (Totally Integrated Laboratory Environment), ETS-Lindgren EMQuest[™] Data Acquisition and Analysis Software, and other test automation software packages. Contact ETS-Lindgren for additional information.

6.0 EMSwitch Remote Relay



CAUTION: Before placing into operation, follow the information provided in *Safety Information* on page v.

For applications that require to switch higher power signals (>700 Watts), it is not possible to use internal relays of the switch cards; in those cases, special dedicated relays are needed in the test setup. For these external relays, EMSwitch™ Model 7001-004 Remote Relay, which is capable of driving two external relays, is available.

Model 7001-004 can drive any relay with a supply voltage of 12V, 24V, or 28V, and from SPDT to SP6T. For each relay a driver current of 0.5A is available, or 1A if only one relay is connected.

The type of relay and the usage of indicator contacts can be configured in software. The connection for relay 1 and relay 2 are identical.

Front and Back Panel Connectors

The front panel includes a key switch and an LED. If the EMSwitch™ Remote Relay is connected to a 220 V AC power supply and the on/off switch on the back panel is set to the **I** position, you can power on the remote relay by turning the key clockwise. The LED will illuminate.

The Remote Relay must be connected to a 220 V AC power supply via the mains lead, connected at the AC inlet on the back panel.

Relays

You can connect four relays to the remote relay. It is possible to connect relays with 1 input and 2, 3, 4, 5, or 6 outputs.

To connect external relays you must use the mating connector set included with the remote relay.

The **relay x drive** connectors on the back panel of the remote relay will switch the relays into position.

- For a 24 V relay, connect pin 1 (24 V DC output) to the Common of the relay power terminals.
- For a 12 V relay, connect pin 2 (12 V DC output) to the Common of the relay power terminals.
- Connect pin 3–8 to the power terminals 1–6 of the relay.

The number of power terminals to connect depends on the type of relay you use. For example, a 1–6 relay requires all of the pins, and a 1–3 relay requires three pins.

Readback Function

The **relay x readback** connectors on the back panel remote relay can verify if the external relay is set into position.

1. Connect pin 1 (3v3 out) to the indicator common of the relay.
2. Connect pin 2 to the first indicator of the relay.
3. Connect pin 3 to the second indicator; continue until complete.

The number of indicator terminals to connect depends on the type of relay you use. Pin 8 is not in use.

Set the readback function on or off in the EMCenter™ Modular RF Platform depending on the number of relay(s) with readback function that you use.

Set Up RS-232 Address

You can connect up to four external switch boxes to one EMCenter. Interconnect the switch boxes with straight RS-232 cables. The DIP switches on the back panel of the EMCenter allow you to set the individual addresses.

DIP Switch				EMSwitch Remote Relay Address
1	2	3	4	
On	On	On	—	Address 1
Off	On	On	—	Address 2
On	Off	On	—	Address 3
Off	Off	On	—	Address 4

This page intentionally left blank.

7.0 Operation



CAUTION: Before placing into operation, follow the information provided in *Safety Information* on page v.



CAUTION: Prior to operation, verify that the mains voltage is within the operating range of the equipment.

Powering On and Off EMCenter



Note: For information on using the EMCenter touchscreen, see the *EMCenter Modular RF Platform User Manual*.

POWER ON



Note: Verify all cards are installed correctly in the EMCenter.

1. Verify that the EMSwitch™ RF Switch Plug-in Card safety relay interlock connection is closed. For more information, see page 29.
2. Plug the power cord from the mains inlet on the back panel of the EMCenter into a power outlet.
3. Plug the interlock jack into the interlock connector on the back panel of the EMCenter.
4. Turn the power switch located on the back panel of the EMCenter to the on position.

5. Touch anywhere on the EMCenter screen. It will take approximately 20 seconds to boot. The Information screen will flash, and then the Home screen will display.

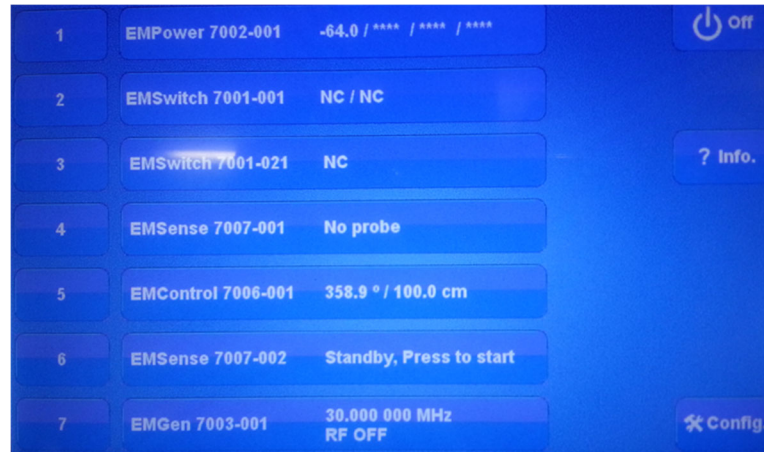

Sample EMCenter Home Screen

POWER OFF

1. Press the **Off** button located on the EMCenter screen.

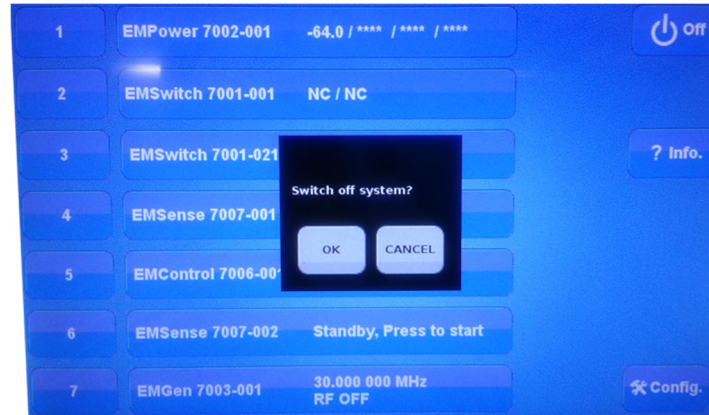

2. Press **OK** to switch off the system.

The standby light located on the front panel of the EMCenter will flash, and then will illuminate steadily.



Note: When the EMCenter is in standby mode, touch the screen anywhere to reboot.

3. Turn the power switch located on the back panel of the EMCenter to the off position.
4. Remove the power cord from the power connector on the back panel of the EMCenter.
5. Remove the interlock jack from the interlock connector on the back panel of the EMCenter.

Manual Control of EMSwitch

To change relay position settings, on the Home screen press the status box to the right of the slot number for the installed EMSwitch plug-in card. This will display the following switch screen:

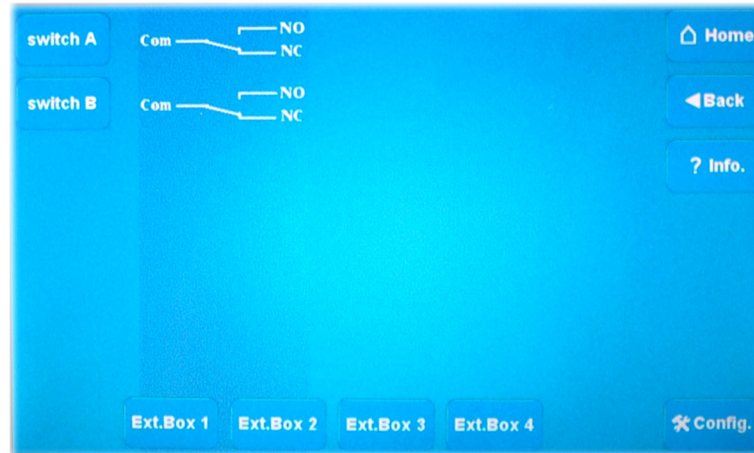

*Sample Switch Screen
(Com—Common NO—Normally Open NC—Normally Closed)*

Press a switch button (**switch A**, **switch B**, and so on) to toggle between **NO** and **NC**.

Safety Interlock Relay

Relay A on each EMSwitch plug-in card can be used as a safety interlock relay. As long as the connector is shorted (by an external interlock switch), the relay can be activated. However, as soon as the interlock circuit opens, relay A will return to the idle position.



Note: If you do not want to use this relay as a safety relay, the connector must be shorted in order to use it as a standard relay.

When the safety interlock relay is activated, the power supply to the first relay of the card will be interrupted (fully hardware controlled), causing the relay to switch to the normally open position. The EMCenter will detect this interlock status and display a message. For safety reasons, the software is not able to overrule this interlock condition.

After the interlock has been closed again, the relay will switch automatically to its original condition.

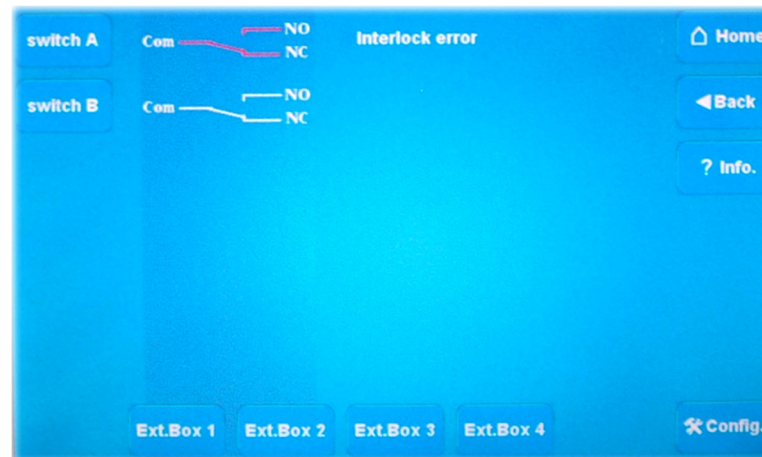

Sample Interlock Error Screen

The interlock hardware is implemented in a redundant way for maximum safety. The interlock relay can be used to interrupt the signal path between the signal generator and the power amplifier. An interlock switch mounted on the door of the test chamber can be used to activate the safety relay, preventing personnel from being subject to high field strengths when entering the test chamber.

Relay Errors

The EMSwitch plug-in card checks for the following error conditions of the internal relays:

1. **Over temperature**—A temperature sensor close to each relay checks for excessive heating of the relay. A **high temperature** error will display if the relay temperature exceeds 85°C (185°F).
2. **Switching error**—Each internal relay has a set of control contacts which are used to check if a relay has changed position. A **switching error** message will appear if this check fails.
3. **Interlock open for safety interlock relay**—When the interlock of relay A is opened, this will result in a **safety interlock open** error.

8.0 EMSwitch Command Set

See *Remote Commands* on page 33 for the commands that can be used with the EMSwitch™ RF Switch Plug-in Card. Each command must include a device ID number as the prefix; see the *EMCenter Modular RF Platform User Manual* for complete information on device ID numbers.



- Terminate each command with a line feed (LF, shown as `\n` in command syntax).
- Each response from the device is terminated with a line feed (LF, shown as `\n` in command syntax).

Examples

EXAMPLE 1: REQUEST SOFTWARE VERSION

To request the software version of the EMSwitch card with device ID number 1:

```
S1:VERSION_SW?
```

EXAMPLE 2: SET INTERNAL RELAY

To set the internal relay A from the EMSwitch card with device ID number 1 to normally open:

```
S1:INT_RELAY_A_NO
```

EXAMPLE 3: SET EXTERNAL RELAY

To set the external relay 3 from the EMSwitch Remote Relay with address 4, connected to the EMSwitch card at slot 2, position 5:

S2:N14RELAY_3_5

- S** = Device character of EMSwitch card
- 2** = Board number of EMSwitch card
- N1** = Indicates EMSwitch card to pass message to external interface
- 4** = Address of EMSwitch Remote Relay (configurable with DIP switches)
- RELAY_** = Message to switch relay
- 3** = Number of switch on EMSwitch Remote Relay
- _** = Separator
- 5** = Instruction to put switch in position 5

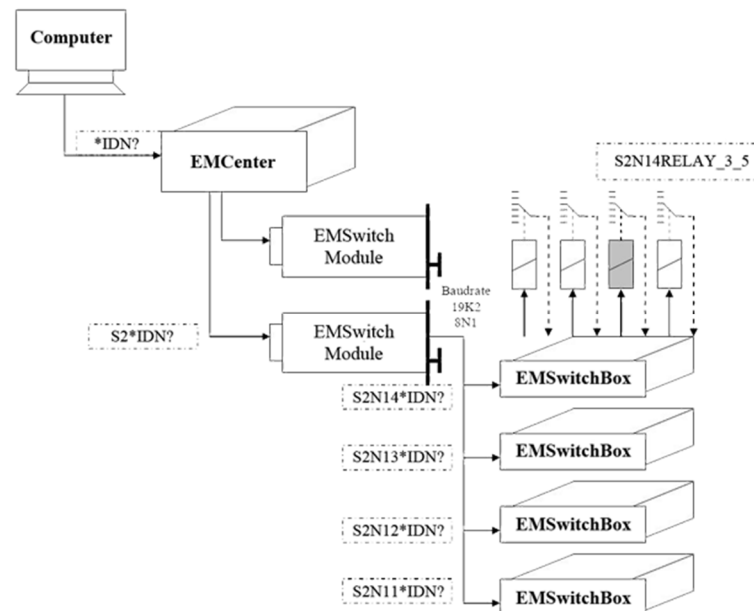

Remote Commands



Note: If you receive an error code in response to a command, see page 37 for a list of error codes.

COMMAND SET—COMMON TO ALL EMSWITCH MODELS

Command / Description	Reply
*IDN? Request device identification.	Model, Version X.Y.Z Example: ETS-Lindgren, EMSwitch 7001-003, 3.5.10
LOCAL Return to local mode, the local display is used to set items.	—
RESET/n Reset (clear the current error).	—
ID_NUMBER? Request unique identifier number.	x.x.x.x.x.x.x
VERSION_SW? Returns the software version number.	x.y.z OR x.y OR x
VERSION_HW? Returns the hardware version number.	x.y.z OR x.y OR x

COMMAND SET—MODEL-SPECIFIC: 7001-001, 7001-002, 7001-011, 7001-012, 7001-021

Description / Command	Reply
Returns the status of internal relay 1 (2, 3, or 4). INT_RELAY_A? INT_RELAY_B? INT_RELAY_C? INT_RELAY_D?	NO or NC
Sets the internal relay A (B, C, or D) to NO. INT_RELAY_A_NO INT_RELAY_B_NO INT_RELAY_C_NO INT_RELAY_D_NO	NO or NC
Sets the internal relay A (B, C, or D) to NC. INT_RELAY_A_NC INT_RELAY_B_NC INT_RELAY_C_NC INT_RELAY_D_NC	NO or NC
Returns the analog temperature of the internal relay A (B, C, or D). INT_TEMPERATURE_A? INT_TEMPERATURE_B? INT_TEMPERATURE_C? INT_TEMPERATURE_D?	100 Three ASCII characters with temperature in degrees Celsius

Description / Command	Reply
Set switch 2 of EMSwitch Remote Relay 1 to position 3. N11RELAY_2_3	OK
Set switch 2 of EMSwitch Remote Relay 2 to position 4. N12RELAY_2_4	OK
Get position of switch 2 of EMSwitch Remote Relay 1. N11RELAY_2?	One of the following: !, 2, 3, 4, 5, 6
Get position of switch 3 of EMSwitch Remote Relay 2. N12RELAY_3?	One of the following: !, 2, 3, 4, 5, 6
Set switch type of switch 3 of EMSwitch Remote Relay 2 to 1 to 2, 1 to 3, 1 to 4, 1 to 5, or 1 to 6. N12RELAYTYPE_3_2 N12RELAYTYPE_3_3 N12RELAYTYPE_3_4 N12RELAYTYPE_3_5 N12RELAYTYPE_3_6	OK
Get switch type of switch 3 of EMSwitch Remote Relay 2. N12RELAYTYPE_2?	One of the following: 2, 3, 4, 5, 6
Disable readback to switch 3 of EMSwitch Remote Relay 2. N12READBACK_3_0	OK
Enable readback to switch 3 of EMSwitch Remote Relay 2. N12READBACK_3_1	OK
Get readback status to switch 3 of EMSwitch Remote Relay 2. N12READBACK_3?	0 (disabled) OR 1 (enabled)

**COMMAND SET—MODEL-SPECIFIC: 7001-003, 7001-005, 7001-013,
7001-015**

Description / Command	Reply
Returns status of internal relay A or B. INT_RELAY_A? INT_RELAY_B?	One of the following: 1, 2, 3, 4, 5, 6
Sets internal relay A or B. INT_RELAY_A_1 INT_RELAY_A_2 INT_RELAY_A_3 INT_RELAY_A_4 INT_RELAY_A_5 INT_RELAY_A_6	One of the following: 1, 2, 3, 4, 5, 6

Error Codes

Error Code	Description
ERROR_201	Switch error while trying to switch to NC (internal relays only)
ERROR_202	Switch error while trying to switch to NO (internal relays only)
ERROR_203	Temperature error NC (internal relays only)
ERROR_204	Temperature error NO (internal relays only)
ERROR_205	Interlock error (internal relays only)
ERROR_206	Error Switch A
ERROR_207	Error Switch B
ERROR_208	Error Switch
ERROR_209	Error external card
ERROR_210	Error no external card connected
ERROR_211	Error status unknown
ERROR_215	Error out of config

This page intentionally left blank.

9.0 Typical Data

Specifications of plug-in cards with SMA connectors

Specification	SMA, 18 GHZ, SPDT relays				
Life Time	10.000.000 cycles				
Frequency	GHz	0 to 3	3 to 8	8 to 12.4	12.4 to 18
VSWR		1.10	1.20	1.20	1.40
Insertion Loss	dB	0.15	0.20	0.25	0.35
Isolation	dB	80	75	65	60
Average Power	W	240	150	120	100

Specification	SMA, 18 GHZ, SP6T relays				
Life Time	5.000.000 cycles				
Frequency	GHz	0 to 3	3 to 8	8 to 12.4	12.4 to 18
VSWR		1.20	1.30	1.40	1.50
Insertion Loss	dB	0.20	0.30	0.40	0.50
Isolation	dB	80	75	65	60
Average Power	W	240	150	120	100

Specifications of plug-in cards with 2.92 mm connectors

Specification	K 2.92 mm, 40 GHz, SPDT relays					
Life Time	10.000.000 cycles					
Frequency	GHz	0 to 6	6 to 12.4	12.4 to 18	18 to 26.5	26.5 to 40
VSWR		1.30	1.40	1.50	1.70	1.9
Insertion Loss	dB	0.30	0.40	0.50	0.70	0.8
Isolation	dB	70	60	60	55	50
Average Power	W	80	60	50	20	10

Specification	K 2.92 mm, 40 GHz, SP6T relays					
Life Time	2.000.000 cycles					
Frequency	GHz	0 to 6	6 to 12.4	12.4 to 18	18 to 26.5	26.5 to 40
VSWR		1.30	1.40	1.50	1.70	2.2
Insertion Loss	dB	0.20	0.40	0.50	0.70	1.1
Isolation	dB	70	60	60	55	50
Average Power	W	40	30	25	15	5

Power Handling

The RF power rating is the capability of handling RF power (CW power) through closed contacts. The RF power should be removed (turned off) before switching the relay.

Power ratings assume the following specifications; see the power handling data chart on page 42.

- Unity VSWR (matched load)
- Room temperature (25°C / 77°F)
- Sea level pressure (14.7 psi)
- Cold switching

Changes to these specifications require power derating; see the VSWR data chart on page 43.

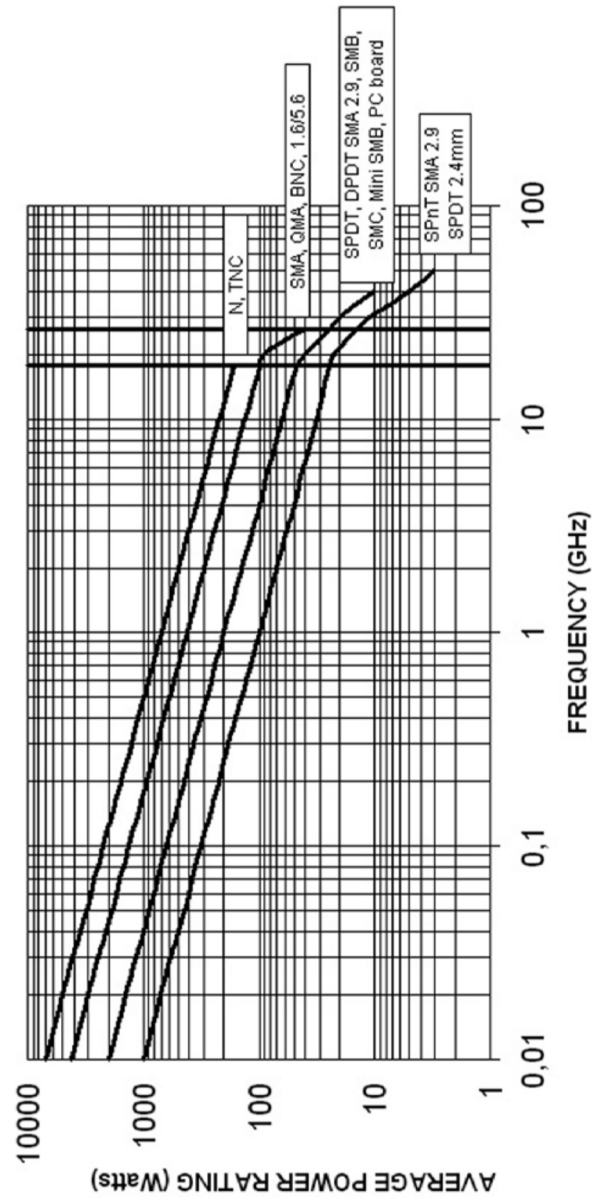

VSWR

The average power input must be reduced for load VSWR. above 1:1.

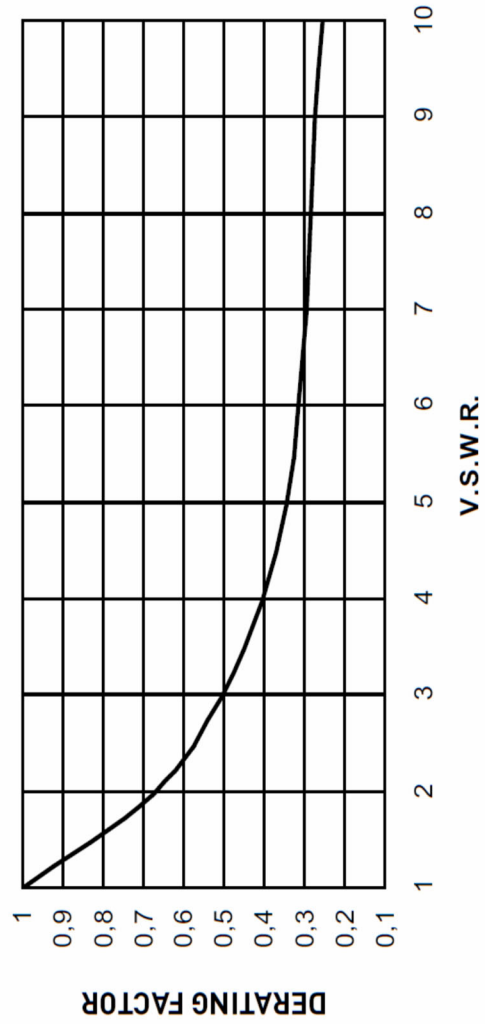

This page intentionally left blank.

Appendix A: Warranty

Scope and Duration of Warranties

Seller warrants to Buyer that the Products to be delivered hereunder will be (1) free from defects in material, manufacturing workmanship, and title, and (2) conform to the Seller's applicable product descriptions and specifications, if any, contained in or attached to Seller's quotation. If no product descriptions or specifications are contained in or attached to the quotation, Seller's applicable product descriptions and specifications in effect on the date of shipment shall apply. The criteria for all testing shall be Seller's applicable product specifications utilizing factory-specified calibration and test procedures and instruments.

All product warranties, except the warranty of title, and all remedies for warranty failures are limited to three years.

Product Warranted	Duration of Warranty Period
EMSwitch™ RF Switch Plug-in Card	3 Years

Any product or part furnished to Buyer during the warranty period to correct a warranty failure shall be warranted to the extent of the unexpired term of the warranty applicable to the repaired or replaced product.

The warranty period shall commence on the date the product is delivered to Buyer; however, if Seller assembles the product, or provides technical direction of such assembly, the warranty period for such product shall commence on the date the assembly of the product is complete. Notwithstanding the foregoing, in the event that the assembly is delayed for a total of thirty (30) days or more from the date of delivery for any reason or reasons for which Seller is not responsible, the warranty period for such product may, at Seller's options, commence on the thirtieth (30th) day from the date such product is delivered to Buyer. Buyer shall promptly inspect all products upon delivery. No claims for shortages will be allowed unless shortages are reported to Seller in writing within ten (10) days after delivery. No other claims against Seller will be allowed unless asserted in writing within thirty (30) days after delivery (or assembly if the products are to be assembled by Seller) or, in the case of alleged breach of warranty, within the applicable warranty period.

Warranty Exclusions

Except as set forth in any applicable patent indemnity, the foregoing warranties are exclusive and in lieu of all other warranties, whether written, oral, express, implied, or statutory. EXCEPT AS EXPRESSLY STATED ABOVE, SELLER MAKES NO WARRANTY, EXPRESS OR IMPLIED, BY STATUTE OR OTHERWISE, WHETHER OF MERCHANTABILITY OR FITNESS FOR ANY PARTICULAR PURPOSE OR USE OR OTHERWISE ON THE PRODUCTS, OR ON ANY PARTS OR LABOR FURNISHED DURING THE SALE, DELIVERY OR SERVICING OF THE PRODUCTS. THERE ARE NO WARRANTIES WHICH EXTEND BEYOND THE DESCRIPTION ON THE FACE HEREOF.

Warranty coverage does not include any defect or performance deficiency (including failure to conform to product descriptions or specifications) which results, in whole or in part, from (1) negligent storage or handling of the product by Buyer, its employees, agents, or contractors, (2) failure of Buyer to prepare the site or provide an operating environmental condition in compliance with any applicable instructions or recommendations of Seller, (3) absence of any product, component, or accessory recommended by Seller but omitted at Buyer's direction, (4) any design, specification, or instruction furnished by Buyer, its employees, agents or contractors, (5) any alteration of the product by persons other than Seller, (6) combining Seller's product with any product furnished by others, (7) combining incompatible products of Seller, (8) interference with the radio frequency fields due to conditions or causes outside the product as furnished by Seller, (9) improper or extraordinary use of the product, or failure to comply with any applicable instructions or recommendations of Seller including maintenance, calibration and cleaning procedures and intervals, or (10) acts of God, acts of civil or military authority, fires, floods, strikes or other labor disturbances, war, riot, or any other causes beyond the reasonable control of Seller.

This warranty does not include (1) batteries, (2) cables, (3) gasket, (4) fingerstock, or any item that is designed to be consumable. Seller does not warranty products of others which are not included in Seller's published price lists.

Buyer's Remedies

If Seller determines that any product fails to meet any warranty during the applicable warranty period, Seller shall correct any such failure by either, at its option, repairing, adjusting, or replacing without charge to Buyer any defective or nonconforming product, or part or parts of the product. Seller shall have the option to furnish either new or exchange replacement parts or assemblies.

Warranty service shall be performed at the Seller's factory, or the Buyer's site at the sole discretion of the Seller. Within the warranty period, the Buyer shall be responsible for all transportation to the Seller's factory, and the Seller shall be responsible for transportation of goods to the Buyer's site.

Within the contiguous 48 United States, warranty service performed during the applicable warranty period will be performed without charge to Buyer during Seller's normal business hours. After the warranty period, service will be performed at Seller's prevailing service rates. Subject to the availability of personnel, after-hours service is available upon request at an additional charge.

Outside the contiguous 48 United States, travel and per diem expenses, when required, shall be the responsibility of the Buyer, or End User, whichever is applicable regardless of the warranty period.

The remedies set forth herein are conditioned upon Buyer promptly notifying Seller within the applicable warranty period of any defect or non-conformance and making the product available for correction.

The preceding paragraphs set forth Buyer's exclusive remedies and Seller's sole liability for claims based on failure of the products to meet any warranty, whether the claim is in contract, warranty, tort (including negligence and strict liability) or otherwise, and however instituted, and, upon the expiration of the applicable warranty period, all such liability shall terminate. IN NO EVENT SHALL SELLER BE LIABLE TO BUYER FOR ANY SPECIAL, INDIRECT, INCIDENTAL OR CONSEQUENTIAL DAMAGES OF ANY KIND ARISING OUT OF, OR AS A RESULT OF, THE SALE, DELIVERY, NON-DELIVERY, SERVICING, ASSEMBLING, USE OR LOSS OF USE OF THE PRODUCTS OR ANY PART THEREOF, OR FOR ANY CHARGES OR EXPENSES OF ANY NATURE INCURRED WITHOUT SELLER'S WRITTEN CONSENT DESPITE ANY NEGLIGENCE ON BEHALF OF THE SELLER. IN NO EVENT SHALL SELLER'S LIABILITIES UNDER ANY CLAIM MADE BY BUYER EXCEED THE PURCHASE PRICE OF THE PRODUCT IN RESPECT OF WHICH DAMAGES ARE CLAIMED. This agreement shall be construed in accordance with laws of the State of Texas. In the event that any provision hereof shall violate any applicable statute, ordinance, or rule of law, such provision shall be ineffective to the extent of such violation without invalidating any other provision hereof.

Any controversy or claim arising out of or relating to the sale, delivery, non-delivery, servicing, assembling, use or loss of use of the products or any part thereof or for any charges or expenses in connection therewith shall be settled in Austin, Texas by arbitration in accordance with the Rules of the American Arbitration Association, and judgment upon the award rendered by the Arbitrator may be entered in either the Federal District Court for the Western District of Texas or the State District Court in Austin, Texas, all of the parties hereto consenting to personal jurisdiction of the venue of such court and hereby waive the right to demand a jury trial under any of these actions.

Appendix B: EC Declaration of Conformity

ETS-Lindgren Inc. declares these products to be in conformity with the following standards, following the provisions of EMC-Directive 2004/108/EC:

EMSwitch RF Switch Plug-In Card

Emission: EN 61326-1:2006, Class B
Electrical equipment for measurement, control, and laboratory use.

Immunity: EN 61326-1:2006, Industrial level, performance criteria A
Electrical equipment for measurement, control, and laboratory use.

Technical Construction Files are available upon request.