

HI-2790B

Calibration Comparison System

User Manual



 **ETS-LINDGREN**[®]
An ESCO Technologies Company

ETS-Lindgren Inc. reserves the right to make changes to any products herein to improve functioning or design. Although the information in this document has been carefully reviewed and is believed to be reliable, ETS-Lindgren does not assume any liability arising out of the application or use of any product or circuit described herein; nor does it convey any license under its patent rights nor the rights of others. All trademarks are the property of their respective owners.

© Copyright 2001–2016 by ETS-Lindgren Inc. All Rights Reserved. No part of this document may be copied by any means without written permission from ETS-Lindgren Inc.

Trademarks used in this document: The *ETS-Lindgren* logo is a trademark of ETS-Lindgren Inc.

Revision Record

MANUAL, HI-2790B | Part # H-600092, Rev. E

Revision	Description	Date
A	Initial Release	February, 2001
B	Updated Power/Control Module information; branding changes	June, 2008
C	Minor edits/updates	June, 2011
D	Minor edits to tables in <i>Operation</i>	October, 2014
E	Updated part numbers and instructions regarding connecting components	May, 2016

Table of Contents

Notes, Cautions, and Warnings	v
General Safety Considerations	v
1.0 Introduction	7
General Description	7
HI-2790B Calibration Comparison System Block Diagram	8
ETS-Lindgren Product Information Bulletin	9
2.0 Maintenance	11
Replacing the Fuse.....	11
Service Procedures	12
Contacting ETS-Lindgren	12
Sending a Component for Service.....	12
Calibration Services and Annual Calibration	12
3.0 Setup	13
Connecting Components	13
4.0 Operation	15
Description of Controls	15
Operation of Controls.....	15
Error Messages	17
Establishing a Reference Field	18
Recording Data	20
Microwave Oven Survey Instrument Daily Ellipticity Check.....	21
Microwave Oven Survey Meter Calibration Comparison, 30-Day Check, Initial Conditions	21
Calibration Comparison	22
30-Day Comparison Requirements	23
5.0 Calibration Comparison Log 30-Day Check	25
6.0 Calibration Comparison Log 2 dB Limitation Check	29
7.0 HI-2790B Operational Log	33
8.0 CDRH Section 8 Report Guidelines	35
8.1 Microwave Test Instruments (Type and Quantity).....	35

8.2 Daily Check.....	35
8.3 30-Day Constancy Check	36
8.4 Repair of Survey and Calibration Instruments.....	37
8.5 Annual Calibration and Periodic Calibration	37
9.0 Specifications.....	39
Appendix A: Warranty	41
Duration of Warranties.....	41
Appendix B: Declaration of Conformity	43

Notes, Cautions, and Warnings



Note: Denotes helpful information intended to provide tips for better use of the product.



Caution: Denotes a hazard. Failure to follow instructions could result in minor personal injury and/or property damage. Included text gives proper procedures.



Warning: Denotes a hazard. Failure to follow instructions could result in **SEVERE** personal injury and/or property damage. Included text gives proper procedures.



Note: See the ETS-Lindgren *Product Information Bulletin* for safety, regulatory, and other product marking information.

General Safety Considerations



Warning: For indoor use only, do not expose to rain..



Note: See the ETS-Lindgren *Product Information Bulletin* for safety, regulatory, and other product marking information.

This page intentionally left blank.

1.0 Introduction

The **ETS-Lindgren HI-2790B Calibration Comparison System** is an instrument calibration comparison system that can be used by microwave oven manufacturers to comply with the Center for Devices and Radiological Health (CDRH) requirements as outlined in *Guide for Preparing Reports on Radiation Safety of Microwave Ovens*, dated March 1985. The HI-2790B is a complete system containing all of the equipment necessary to check microwave oven survey instruments and monitor the calibration stability of these instruments. This involves checking each instrument periodically to make sure that its response is within specification, and its calibration remains constant. This must not be confused with performance of absolute calibration or transfer calibration on the instrument.

In addition to defining a standard format for data, the information provided in this manual is intended to guide the oven manufacturer in establishing procedures for using the HI-2790B system to generate information for reporting to the U.S. Food and Drug Administration, Department of Health and Human Services, Center for Devices and Radiological Health.



Note: The HI-2790B system replaces the HI-2790A and HI-2795A Calibration Comparison Systems. The HI-2790B system offers a broader, continuous power range from 0.1 to more than 5 mW/cm². The internal microwave (2.45 GHz) power source offers a more stable RF signal to the test chamber. The HI-2790B Power/Control Module has a single mains input operating from 100 to 240 VAC, 50/60 Hz.

General Description

The HI-2790B system consists of:

- A portable anechoic chamber mounted on a frame with castor wheels for ease of movement.
- A Power/Control Module containing a 2450 MHz source and a power meter for monitoring power to the waveguide and forward, reflected, and transmitted power.

- An HI-1710 Microwave Survey Meter to serve as a Local Calibration Reference (HI-1710 LCR).



Note: For maximum accuracy and traceability, the HI-1710A LCR and the HI-2623 Probe/Preamp Assembly must be used together as a single unit. The HI-2623 assembly should not be used for general oven leakage testing or any other purpose.

The HI-1710A LCR and the HI-2790B Power/Control Module are mounted on top of the cabinet toward the rear edge. The Power/Control Module is connected directly to the waveguide through a coax cable assembly. The waveguide penetrates the chamber and terminates in a slot antenna radiating toward the probe holding fixture. The fixture is mounted in the wall directly opposite the slot antenna.

The probe holding fixture is slotted so that the probe can be inserted into the chamber without removing the probe spacer cone. The fixture allows the probe under test to be rotated 360 degrees, but has adequate friction to limit axial motion. A fixture mounted on a horizontal cross-member in the chamber accurately maintains the spacing of the probe sensing head to the slot antenna.

HI-2790B CALIBRATION COMPARISON SYSTEM BLOCK DIAGRAM

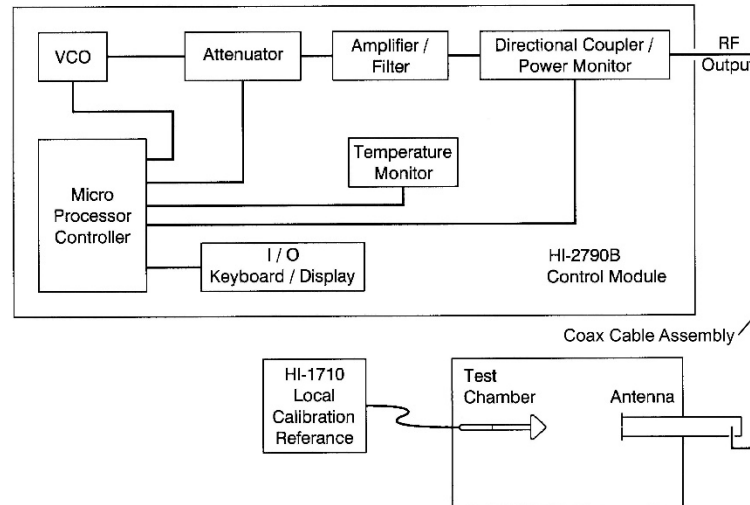

ETS-Lindgren Product Information Bulletin

See the ETS-Lindgren *Product Information Bulletin* included with your shipment for the following:

- Warranty information
- Safety, regulatory, and other product marking information
- Steps to receive your shipment
- Steps to return a component for service
- ETS-Lindgren calibration service
- ETS-Lindgren contact information

This page intentionally left blank.

2.0 Maintenance



CAUTION: Before performing any maintenance, follow the safety information in the ETS-Lindgren *Product Information Bulletin* included with your shipment.



WARNING: Maintenance of the HI-2790B and HI-1710A LCR is limited to external components such as cables or connectors.



Clean the exterior of the cabinet using a damp cloth and mild cleaner. Always unplug the unit before cleaning. Keep the interior of the cabinet free of any foreign objects.

Warranty may be void if the housing is opened.



If you have any questions concerning maintenance, contact ETS-Lindgren Customer Service.

Replacing the Fuse



Caution: Disconnect the HI-2790B and HI-1710A from power before replacing a fuse.

If the HI-2790B Calibration Comparison System or HI-1710A Microwave Survey Meter (HI-1710A LCR) fails to operate, check for a blown fuse inside the power entry module. A blown fuse must be replaced with the same value and type of fuse, or an unsafe condition may result. Use only 250 Volt, 1.0 Amp, Type T (5 mm x 20 mm) fuses.

To replace a fuse:

1. Two fuses are located in the fuse drawer in the power input module. Use a screwdriver to open the drawer.
2. The fuse towards the outside of the drawer is the spare. Remove the spare fuse from the module.

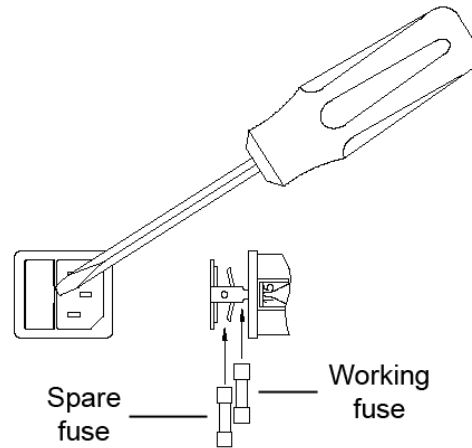

3. Replace the blown fuse with the spare fuse.
4. Slide the fuse drawer back into the module. Make sure that the drawer snaps securely into its locked position.

Service Procedures

CONTACTING ETS-LINDGREN



Note: Please see www.ets-lindgren.com for a list of ETS-Lindgren offices, including phone and email contact information.

SENDING A COMPONENT FOR SERVICE

For the steps to return a system or system component to ETS-Lindgren for service, see the *Product Information Bulletin* included with your shipment.

CALIBRATION SERVICES AND ANNUAL CALIBRATION

See the *Product Information Bulletin* included with your shipment for information on ETS-Lindgren calibration services.

3.0 Setup



CAUTION: Before connecting any components, follow the safety information in the ETS-Lindgren *Product Information Bulletin* included with your shipment.

Connecting Components

See *HI-2790B Calibration Comparison System Block Diagram* on page 8 for a description of connections.

1. Connect the HI-2790B Power/Control Module and the HI-1710A Microwave Survey Meter (HI-1710A LCR) to the mains power supply.



Note: Some models of the HI-1710A LCR provide a voltage setting switch at the power input to select 115 or 220 VAC input voltage.

2. Attach one end of the coax cable assembly to the RF output connector on the HI-2790B Power/Control Module.
3. Attach the other end of the coax cable assembly to the input connector on the waveguide.

This page intentionally left blank.

4.0 Operation



CAUTION: Before placing into operation, follow the safety information in the ETS-Lindgren *Product Information Bulletin* included with your shipment.

Description of Controls

The following controls on the HI-2790B Power/Control Module allow the control, adjustment, and monitoring of all functions of the HI-2790B Calibration Comparison System.

Control	Function
POWER	Turns unit on and off.
RF	Turns RF power to the test chamber on and off.
RF LEVEL	Adjusts power level up and down.
CAL	Sets HI-2790B Power/Control Module to calibration mode. This mode adjusts the RF Power display to read a calibrated value that matches the reading on the HI-1710A LCR.
DISPLAY SELECT	Selects the Operating menu or the Status menu.
UP / DOWN	Steps the display through the selected menu.

Operation of Controls

Operation	Screen
-----------	--------

1. Turn on power to the HI-1710A LCR and the HI-2790B Power/Control Module.

The two modes of the Power/Control Module that display are **Operating** and **Status**. When initially turned on, the product screen displays.



The version screen displays, and then the RF power operating mode screen displays.



2. In Operating mode, the home (initial) screen is RF power. Press the UP ARROW key and the DOWN ARROW key to change the displayed parameters within the selected Operating mode. The following parameters are displayed in the Operating mode:

- **RF Power** 
- **Reflected Power** 
- **Forward Power** 

Operation	Screen
<ul style="list-style-type: none"> • Net or Difference Power—DIF power is the difference between the forward and reflected power values, and represents the net power delivered to the chamber. 	

Error Messages



Note: There are no user serviceable error messages.

The HI-2790B Power/Control Module continually monitors the power supply voltages, the forward and reflected power levels, and the phase lock loop. If any of these readings fall outside the correct operating range of the unit, the unit will turn off the RF power and display one of the following messages:

- **10.5V LO**
- **10.5V HI**
- **6V LO**
- **6V HI**
- **5V LO**
- **5V HI**
- **REF HI**
- **FOR HI**
- **LOCK LOST RESET**

If an error message appears, turn the HI-2790B Power/Control Module off to reset the unit, and then turn it on again. If the error message persists, return the unit to ETS-Lindgren for service.

Establishing a Reference Field

4.1.1	Position the HI-1710A LCR sensing probe in the probe holder with the rear of the probe head firmly seated against the end of the holding fixture. Insert the end of the probe handle into the probe holder and tighten the thumbscrew.
4.1.2	Select the 0–2 mW/cm ² range, FAST response (Filter 2), and the PEAK HOLD selection to OFF (PEAK HOLD LED is not lit).
4.1.3	Turn on the RF and adjust the RF LEVEL until approximately 1.00 mW/cm ² is displayed on the HI-1710A LCR.
4.1.4	Allow the system to stabilize for ten minutes with the RF switch on.
4.1.5	Rotate the probe in the probe holder, noting the highest reading and the lowest reading in one full rotation of the probe. Using the highest and lowest observed readings, rotate the probe to obtain a reading exactly midway between the high and low reading. Alternately, a mark can be made on the probe handle to allow repositioning the probe at the same point for all 30-day comparisons.
4.1.6	With the probe adjusted or rotated for a mid-reading, readjust the RF LEVEL to obtain an indication on the HI-1710A LCR of 1.00 mW/cm ² .
4.1.7	Make sure the Power/Control Module is displaying RF Power. If not sure, press the UP and DOWN keys simultaneously to change the display to the RF Power indication.
4.1.8	Calibrate the HI-2790B Power/Control Module RF Power reading by pressing and holding the CAL button, and then pressing the UP or DOWN buttons until the Power/Control display indicates the same value as the HI-1710A LCR (typically 1.00).
4.1.9	With the RF power on and the HI-1710A LCR indicating 1.00, note the Power/Control Module in the FWD, REF, and DIF readings and record in the operational log. Rotate the probe through one complete revolution and record the highest and the lowest readings. Check the ZERO condition of the HI-1710A LCR and re-zero if necessary. The HI-2790B system is now ready to perform calibration checking.

4.1.10	Check the system field level at 1 mW/cm ² by placing the HI-1710A LCR probe in the chamber and aligning the probe at its midpoint reading.
4.1.11	Remove the HI-1710A LCR probe and place it in its holder on top of the system.
4.1.12	This ends the setup procedure for the HI-2790B system. The information logged in step 4.1.9 on page 18 must be reviewed to make sure that the HI-2790B system remains stable. No value of the DIF or the RF Power reading may be lower than 10% less than the highest reading observed over a 12-month period between annual calibrations of the HI-1710A LCR. If a reading falls below these limits, carefully review and repeat the setup procedure. If it is still outside the limits, check the rest of the data for indications of the problem area. The HI-1710A LCR bias, ellipticity, and the ambient temperature readings should also remain within specified limits.

Recording Data

Record the following data in a permanent log similar to the example *HI-2790B Operational Log* on page 33.

4.2.1	Each log should identify the HI-2790B Power/Control Module serial number and the serial numbers of the HI-1710A LCR and HI-2623 Probe/Preamp Assembly.
4.2.2	Date.
4.2.3	Power/Control Module FWD, REF, DIFF, and RF Power readings (at 1.0 mW/cm ²).
4.2.4	HI-1710A LCR bias voltage.
4.2.5	HI-1710A LCR ellipticity values (maximum, minimum, and mean).
4.2.6	Ambient temperature and Power/Control Module internal temperature.
4.2.7	The REMARKS column, in addition to noting unusual observations, should identify whether daily checks or 30-day checks are being performed, the type of instrument being checked, and so on.
4.2.8	Power/Control Module RF Power (at mW/cm ²).
4.2.9	The person performing the test should be identified in the Initial column.

Microwave Oven Survey Instrument Daily Ellipticity Check

4.3.1	Zero the instrument to be checked, making sure the access door is closed and the RF switch is off. Insert the probe of the instrument to be measured into the HI-2790B probe holding fixture. Make sure the probe is properly located against the stop on the holding fixture. Set the scale of the instrument to that used for compliance testing (usually the 0-2 mW/cm ² range).
4.3.2	Turn RF POWER switch on and adjust the RF LEVEL control to obtain a mid-scale reading (approximately 1 mW/cm ²) on the meter being checked.
4.3.3	Rotate the probe to obtain the minimum reading.
4.3.4	Readjust the RF POWER control so that the meter on the instrument being checked indicates precisely 1.0 mW/cm ² .
4.3.5	Rotate the probe to obtain the maximum reading.
4.3.6	If this value is less than 1.10 mW/cm ² , the calibration status of the meter is acceptable. If greater than 1.10 mW/cm ² , it may be rejected.
4.3.7	Record in a permanent log the daily checks on all instruments, indicating whether each instrument was accepted or rejected.

Microwave Oven Survey Meter Calibration Comparison, 30-Day Check, Initial Conditions

4.4.1	Meters to be checked must be turned on and allowed to stabilize in accordance with the manufacturer recommendations.
4.4.2	Select the desired probe range, zero the instrument, making sure the access door is closed and the RF switch is off, and place the instrument on top of the HI-2790B system to the left of the door.
4.4.3	Place the probe in the holder as described in step 4.1.1 on page 18. Close the door.

Calibration Comparison

4.5.1	With the Power/Control Module RF POWER set to OFF, check that the instrument being checked is properly zeroed. Turn the RF Power switch on and check that the indicated RF POWER is 1.0 mW/cm ² as established in step 4.1.9 on page 18. Rotate the probe slowly through one full revolution (360 degrees) and record the maximum and minimum readings.
4.5.2	Add the MAX reading to the MIN reading and divide the sum by two. The result is the MEAN value.
4.5.3	<p>Subtract the MIN reading from the MAX reading, divide the result by the MEAN reading from the previous step, and then multiply this result by 100. This is the TOTAL ELLIPTICITY in percent. The maximum allowable ellipticity should be obtained from the manufacturer specifications. Enter these values into the <i>Calibration Comparison Log</i>.</p> <p>Example: The test indicates a MAX value of 1.023 and a MIN value of 0.985.</p> <ul style="list-style-type: none">• Add 1.023 and 0.985. This equals 2.008.• Divide 2.008 by 2. This gives a MEAN value of 1.004.• Subtract the MIN value (0.985) from the MAX value (1.023). This gives a value of 0.038. <p>Divide 0.038 by the MEAN value (1.004), and then multiply the result by 100. This gives a TOTAL ELLIPTICITY of 3.78%.</p>

30-Day Comparison Requirements

4.6.1	No value of the MEAN reading of any instrument may be lower than 90% of the highest reading observed over a 12-month period between annual calibrations of the HI-1710A LCR. Any time the MEAN reading or ELLIPTICITY reading is outside the specified limits, that instrument must be rejected. It should be returned to the original manufacturer for repair and/or recalibration. Never attempt to adjust the calibration of an instrument. See <i>Calibration Comparison Log 30-Day Check</i> on page 25 for suggested log, examples, and forms usage instructions.
4.6.2	No two acceptable instruments shall yield readings that differ by more than 2 dB, including polarization extremes. See <i>Calibration Comparison Log 2 dB Limitation Check</i> on page 29 for log forms and suggested procedure. A separate 2 dB band may be used for all instruments checked on a given HI-2790B system.

This page intentionally left blank.

5.0 Calibration Comparison Log 30-Day Check

To make sure that microwave survey instruments are being checked in accordance with Center for Devices and Radiological Health (CDRH) guidelines, complete the *Calibration Comparison Log 30 Day Check* form on page 26 using the following instructions, and in conjunction with the HI-2790B Calibration Comparison System.



Note: The word MEAN is used to refer to the average or center value of the polarization ellipticity reading.

5.1.1	A separate log should be kept for each instrument, identifying it by model number and serial number.
5.1.2	Record the maximum, minimum, and mean values, and calculate the ellipticity as follows: Total % ellipticity = $\frac{\text{MAX minus MIN}}{\text{MEAN}} \times 100$
5.1.3	Comparison readings should always be made at the mean and for a given instrument. No reading may be lower than 10% below the highest reading during the 12-month period between annual calibrations. <ul style="list-style-type: none">• The first reading in a 12-month period between annual calibrations will always be acceptable if it is within the dB band for all instruments.• The ellipticity must be within the manufacturer specifications. For ETS-Lindgren instruments the limit is 10% total, plus or minus 5%. Compare the mean reading and the ellipticity reading against these limits and determine acceptance or rejection.

5.1.4	The person performing the test should be identified in the INITIAL column.
5.1.5	The mean readings and/or limits may be graphically displayed as desired in the chart space provided at the bottom of the log.
5.1.6	Logs for an acceptable meter and a rejected meter are shown in the example logs on pages 27 and 28.

CALIBRATION COMPARISON LOG 30 DAY CHECK

Holiday Survey Meter Model No. _____, Serial No. _____

PERIOD	DATE	MAX	MIN	MEAN	ELLIPT	COMMENTS	ACC/ REJ	INITIAL
1								
2								
3								
4								
5								
6								
7								
8								
9								
10								
11								
12								

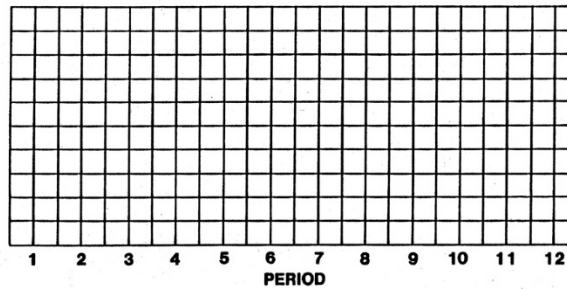

CALIBRATION COMPARISON LOG 30 DAY CHECK

Holiday Survey Meter Model No. 1700 Serial No. 37212

PERIOD	DATE	MAX	MIN	MEAN	ELLPT	COMMENTS	ACC/REJ	INITIAL
1	3/12/84	1.04	.99	1.015	.049		A	BJ
2	4/16/84	1.05	.99	1.02	.059	10% low limit is .918 (1.02-10%)	A	BJ
3	5/14/84	1.05	.97	1.01	.079		A	BJ
4	6/18/84	.99	.93	.96	.062		A	BJ
5	7/16/84	1.03	.95	.99	.081		A	BJ
6	8/13/84	.96	.88	.92	.087		A	BJ
7	9/17/84	.99	.93	.96	.062		A	BJ
8	10/5/84	1.03	.95	.99	.081		A	BJ
9	11/19/84	1.06	.97	1.015	.089		A	BJ
10	12/7/84	.98	.91	.945	.074		A	BJ
11	1/14/85	1.04	.97	1.005	.070		A	BJ
12	2/11/85	.99	.92	.955	.073		A	BJ

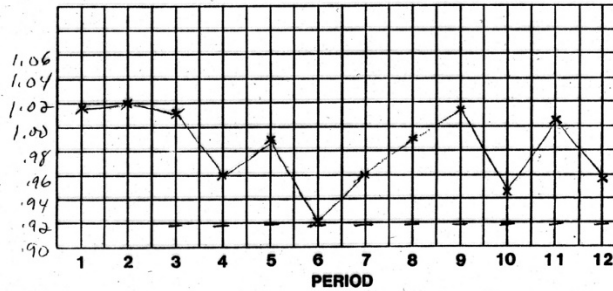

CALIBRATION COMPARISON LOG 30 DAY CHECK

Holiday Survey Meter Model No. 1501, Serial No. 24989

PERIOD	DATE	MAX	MIN	MEAN	ELLPT	COMMENTS	ACC/REJ	INITIAL
1	3/12/84	.99	.93	.96	.062		A	BS
2	4/16/84	.96	.88	.92	.087		A	BS
3	5/14/84	1.09	.97	1.005	.070	low limit is .904 (1.005 - 10%)	A	BS
4	6/18/84	.99	.92	.955	.073		A	BS
5	7/16/84	1.06	1.00	1.03	.058	new low limit is .927	R	BS
6								
7								
8								
9								
10								
11								
12								

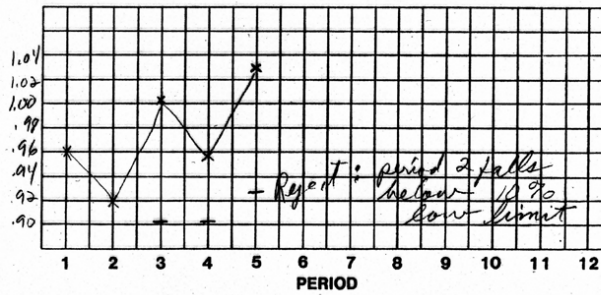

6.0 Calibration Comparison Log 2 dB Limitation Check

See the example logs on pages 31 and 32. Every 30 days review the results of the 30-day calibration comparison check on all meters, including the HI-1710A LCR. Note the highest (max) reading and the lowest (min) reading from all meters for the current 30-day check. This information can be obtained from the **MAX** and the **MIN** columns on the *Calibration Comparison Log 30-day Check* log for each meter.

6.1.1	Record the highest max and the lowest min on the <i>Calibration Comparison Log 2 dB Limitation Check</i> on page 31. For the first month the highest max will be A and the lowest min will be B.
6.1.2	For the future months A must be updated to the highest max and B must be updated to the lowest min.
6.1.3	Divide the highest max by the lowest min to obtain the ratio A/B. If the ratio is less than 1.59, enter Yes in the last column. If the ratio is greater than 1.59, enter No .
6.1.4	If the ratio is greater than 1.59, action must be taken to reduce the ratio A/B to less than 1.59. For example, the log on page 32 reports an unacceptable result for March 1985. It indicates a new meter introduced in January read higher than the other meters, but that all readings were within acceptable limits. In March, however, it forced the A/B ratio to exceed 1.59. Removing that meter from service dropped the A number back to its former level.

CALIBRATION COMPARISON LOG
2 dB Limitation Check

Calibration Comparison System No. _____

Period	Date of 30 day check	Highest Max	Lowest Min	A	B	A/B	A/B Less than 1.59?	Comments
1								
2								
3								
4								
5								
6								
7								
8								
9								
10								
11								
12								

Period is the number of months since the last LCR calibration.
Readings must include polarization extremes.

CALIBRATION COMPARISON LOG
2 dB Limitation Check

Calibration Comparison System No. 48312

Period	Date of 30 day check	Highest Max	Lowest Min	A	B	A/B	A/B Less than 1.59?	Comments
1	10-7-85	1.17	.88	1.17	.88	1.33	Yes	
2	11-4-85	1.14	.86	1.17	.86	1.36	Yes	
3	12-3-85	1.16	.90	1.17	.86	1.36	Yes	
4	1-6-86	1.09	.92	1.17	.86	1.36	Yes	
5	2-3-86	1.20	.88	1.20	.86	1.39	Yes	
6	3-4-86	1.22	.84	1.22	.84	1.45	Yes	
7	4-7-86	1.14	.95	1.22	.84	1.45	Yes	
8	5-5-86	1.17	.89	1.22	.84	1.45	Yes	
9	6-3-86	1.10	.90	1.22	.84	1.45	Yes	
10	7-7-86	1.20	.88	1.22	.84	1.45	Yes	
11	8-4-86	1.18	.90	1.22	.84	1.45	Yes	
12	9-4-86	1.17	.96	1.22	.84	1.45	Yes	

Period is the number of months since the last LCR calibration.
Readings must include polarization extremes.

CALIBRATION COMPARISON LOG
2 dB Limitation Check

Calibration Comparison System No. 483/2

Period	Date of 30 day check	Highest Max	Lowest Min	A	B	A/B	A/B Less than 1.58?	Comments
1	10-5-84	1.17	.90	1.17	.90	1.3	Yes	
2	11-5-84	1.10	.88	1.17	.88	1.33	Yes	
3	12-4-84	1.20	.84	1.20	.84	1.43	Yes	
4	1-7-85	1.29	.90	1.29	.84	1.53	Yes	
5	2-4-85	1.33	.87	1.33	.84	1.58	Yes	
6	3-4-85	1.35	.92	1.35	.84	1.61	NO	See note below
7	4-2-85	1.19	.88	1.33	.84	1.58	Yes	
8	5-6-85	1.16	.90	1.33	.84	1.58	Yes	
9	6-3-85	1.15	.88	1.33	.84	1.58	Yes	
10	7-8-85	1.18	.88	1.33	.84	1.58	Yes	
11	8-5-85	1.20	.84	1.33	.84	1.58	Yes	
12	9-5-85	1.11	.86	1.33	.84	1.58	Yes	

Period is the number of months since the last LCR calibration.
Readings must include polarization extremes.

Note: HI-1501, SN 33333 removed from service 3-4-85. Highest max
No now 1.20 and A/B = 1.33/.84 or 1.58.

This page intentionally left blank.

8.0 CDRH Section 8 Report Guidelines

Following is a suggested set of answers to Section 8 of the Center for Devices and Radiological Health (CDRH) *Guide for Preparing Reports on Radiation Safety of Microwave Ovens*.

8.1 Microwave Test Instruments (Type and Quantity)

To be answered by each oven manufacturer. List the manufacturer, model number, and quantity of meters as requested.

For example: ETS-Lindgren Model HI-1501, quantity: 13

8.2 Daily Check

8.2.1	Check Yes .
8.2.2	Check Yes .
8.2.3	Check Yes .
8.2.4	The maximum allowable polarization ellipticity for all ETS-Lindgren microwave survey meters is $\pm 5\%$, or 10% total, or 0.10 total. See the manufacturer specifications for allowable ellipticity for other models.
8.2.5	Check Yes .
8.2.6	Check Yes .
8.2.7	ETS-Lindgren Calibration Comparison System Model number (insert model number) is used for performing the daily check on all hand scan instruments. The daily check of the Automated Microwave Oven Screening System (AMOSS) is performed in accordance with the sign-on self-test criteria that are part of the operational program of AMOSS.

8.2.8	Check Yes .
8.2.9	Check Yes .
8.2.10	Check box and supply a sample of the daily check record for a hand-held meter and a sample print-out of the AMOSS daily sign-on log form.

8.3 30-Day Constancy Check

8.3.1	<p>Instrument Intercomparison System</p> <ul style="list-style-type: none"> • Manufacturer name and model number: ETS-Lindgren Model HI-2790B • RF source frequency and frequency stability: 2450 MHz, ± 0.1 MHz • RF source amplitude modulation: CW with approximately 1% ripple • HI-1710A LCR manufacturer and model number: ETS-Lindgren Model HI-1710A • Radiated Power Monitor (RPM) manufacturer and model number: N/A
8.3.2	Do not check this box.
8.3.3	Check Yes .
8.3.4	Check Yes .
8.3.5	<p>A. Check HI-1710A LCR. B. Check HI-1710A LCR.</p>
8.3.6	Check Yes .
8.3.7	Check Yes .
8.3.8	Check the box, enclose a copy of a page of the Operational Log from the system, and label it Attachment 8.3.8 .
8.3.9	Check Yes .
8.3.10	Check Yes .

8.3.11	Check Yes .
8.3.12	Check Yes .
8.3.13	Check the box, enclose a copy of the 2 dB Limitation Check Log, and label it Attachment 8.3.13 .
8.3.14	Check Yes .
8.3.15	Check the box, enclose a copy of the 30-day Check Log, and label it Attachment 8.3.15 .

8.4 Repair of Survey and Calibration Instruments

8.4.1	All microwave survey compliance instruments are repaired and recalibrated by ETS-Lindgren.
8.4.2	Check the box and include a copy of your procedure, and label it Attachment 8.4.2 .
8.4.3	The HI-1710A LCR and Power/Control Module are repaired and recalibrated by ETS-Lindgren.
8.4.4	Check Yes .

8.5 Annual Calibration and Periodic Calibration

8.5.1	Check No and add Only the LCR .
8.5.2	Check Yes and enter annually in the blank.



Note: The oven manufacturer procedures must provide adequate documentation to back up the statements and check marks made in this section

This page intentionally left blank.

9.0 Specifications

Frequency:	2450 + 0.1 MHz over an ambient temperature range of 20 degrees to 24 degrees C
Frequency Stability:	50 ppm/°C + 0.0025%
Dynamic Range:	0.1 – 5 + mW/cm ² Plane-wave equivalent power density at probe test location.
Input Power:	100 – 240 VAC 0.8 – 0.4 A max 50 – 60 Hz
Fuses:	250 Volt, 1.0 Amp, Type T (5 mm x 20 mm)
Output:	2450 MHz, 4 W max Do not operate without 50 ohm load.
Local Calibration Reference:	HI-1710A Microwave Survey System (HI-1710A LCR)
Size:	<ul style="list-style-type: none"> • Width: 770 mm wide • Depth: 1040 mm deep • Height: 1230 mm high (1360 mm with HI-2790B Power/Control Module)
Weight:	45 kg (shipping) (100 lbs)
Support:	Castor wheels for ease of location

Repeatability of Measurements:	If the recommended procedures are followed, an operator can repeat measurements to plus or minus 2% (of this, plus or minus 1% will be due to the last digit uncertainty of the digital meter on the HI-1710A LCR).
Inside Dimensions of Anechoic Material:	18 in x 18 in x 18 in
Environmental:	<ul style="list-style-type: none"> • Operating temperature: 10 degrees to 40 degrees C • Humidity: 5% to 95% relative humidity, non-condensing
Power Cable:	This unit is shipped with a three-wire power cable that meets or exceeds the requirements of EN60799. When this cable is connected to an appropriate AC power source, it connects the chassis to earth ground. The type of power cable shipped with each unit depends on the country of destination.



Note: The power cable used must be rated for a minimum of 250V/10A.

Appendix A: Warranty



Note: See the *Product Information Bulletin* included with your shipment for the complete ETS-Lindgren warranty for your HI-2790B Calibration Comparison System.

Duration of Warranties

All product warranties, except the warranty of title, and all remedies for warranty failures are limited to one year.

Product Warranted	Duration of Warranty Period
HI-2790B Calibration Comparison System	1 Year

This page intentionally left blank.

Appendix B: Declaration of Conformity

Factory

ETS-Lindgren L.P.
1301 Arrow Point Drive
Cedar Park, TX, USA 78613

Issued by

ETS-Lindgren L.P.
1301 Arrow Point Drive
Cedar Park, TX, USA 78613

ETS-Lindgren L.P. declares under sole responsibility that the:

Model / Part Number: HI-2790B
Model / Part Name: Calibration Comparison System
Date of Declaration: April 19, 2001

to which this declaration relates, meets the requirements and is in conformity with the relevant EC Directives listed in the following using the relevant section(s) of the EC harmonized standards and other normative documents:

APPLICABLE DIRECTIVE(S)

- Low Voltage Directive (LVD), 73/23/EEC and its amending directives
- Electromagnetic Compatibility Directive (EMC), 89/336/EEC and its amending directives

APPLICABLE HARMONIZED STANDARDS(S) AND/OR NORMATIVE DOCUMENT(S)

- EN 61000-3-2:1995 Electromagnetic Compatibility (EMC) – Part 3: Limits Section 2: Limits for harmonic current emissions (equipment input current less than or equal to 16 A per phase)
- EN 61000-3-3:1995 Electromagnetic Compatibility (EMC) – Part 3: Limits Section 3: Limitation of voltage fluctuations and flicker in low-voltage supply systems for equipment with rated current less than or equal to 16 A
- EN 61010-1: Safety requirements for electrical equipment for measurement, control, and laboratory use – Part 1: General requirements (IEC 1010-1 : 1990 + A1 : 1992, Modified)

- EN 61326:1997 (Amendment A1: 1998) Electrical equipment for measurement, control, and laboratory use – EMC requirements
- EN 61326-1:1997 Electrical equipment for measurement, control, and laboratory use—EMC requirements

AUTHORIZED SIGNATORIES



Bryan Sayler,
General Manager

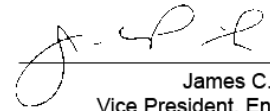

James C. Psencik,
Vice President, Engineering

The authorizing signatures on this Declaration of Conformity document authorize ETS-Lindgren L.P. to affix the CE mark to the indicated product. CE marks placed on these products will be distinct and visible. Other marks or inscriptions liable to be confused with the CE mark will not be affixed to these products.

ETS-Lindgren L.P. has ensured that technical documentation shall remain available on premises for inspection and validation purposes for a period ending at least 10 years after the last product has been manufactured.