

Models 7002-001 | 7002-002, 7002-003, 7002-004, 7002-005

EMPower™ Meter Plug-in Card and USB RF Power Sensor

User Manual



ETS-Lindgren Inc. reserves the right to make changes to any products herein to improve functioning or design. Although the information in this document has been carefully reviewed and is believed to be reliable, ETS-Lindgren does not assume any liability arising out of the application or use of any product or circuit described herein; nor does it convey any license under its patent rights nor the rights of others. All trademarks are the property of their respective owners.

© Copyright 2015-2019 by ETS-Lindgren Inc. All Rights Reserved. No part of this document may be copied by any means without written permission from ETS-Lindgren Inc.

Trademarks used in this document: The *ETS-Lindgren* logo is a registered trademark, and *EMCenter*, *EMPower*, *TILE!*, and *EMQuest* are trademarks of ETS-Lindgren Inc.; *Microsoft* and *Windows* are registered trademarks of Microsoft Corporation in the United States and/or other countries.

Revision Record

MANUAL, EMPOWER CARD | Part #399345, Rev. B

Revision	Description	Date
A	Initial Release	March, 2015
B	Update	September, 2019

Table of Contents

Notes, Cautions, and Warnings	v
Safety Information	v
1.0 Introduction	6
Product Characteristics	6
Standard Configuration.....	7
EMCenter™ Modular RF Platform	7
EMPower™ Meter Plug-In Card	7
EMPower™ USB RF Power Sensor	8
Shielded USB Cable	9
Optional Configuration.....	9
Software	9
Other Items	9
2.0 Maintenance	10
Replacement and Optional Parts.....	10
Service Procedures	11
Contacting ETS-Lindgren.....	11
Sending a Component for Service	11
3.0 Specifications.....	12
EMPower™ Meter Plug-in Card Specifications (Model 7002-001)	12
Physical Specifications	12
Environmental Specifications.....	12
Electrical Specifications	12
EMPower™ USB RF Power Sensor (Models 7002-002 & -004)	12
Physical Specifications	12
Environmental Specifications.....	13
Electrical Specifications	13
EMPower™ USB RF Power Sensor (Models 7002-003 & -005)	13
Physical Specifications	13
Environmental Specifications.....	14
Electrical Specifications	14
4.0 EMPower Plug-In Card Installation.....	16
5.0 Manual Operation with EMCenter.....	18
Powering On and Off.....	18

Powering On	18
Powering Off	19
Access Sensor Settings.....	20
Frequency	21
Filter	21
Offset.....	22
Net Power	22
Gain.....	23
VSWR	23
6.0 Computer Operation of Sensor.....	25
Stand alone terminal program controlled sensor.....	25
TILE! controlled sensor	26
7.0 Command Set.....	27
Syntax for EMCenter commands.....	27
Description of Different Sensor Modes.....	28
Mode 0: RMS Power.....	28
Mode 1: Peak Power.....	28
Mode 2: Envelope Tracing	29
Mode 3: Burst Logging	29
Commands for All Sensor Modes.....	29
Mode 2 Sensor Commands (Envelope Tracing Mode).....	32
Response Times for Data Readout Mode 2 - Envelope Tracing	34
Graphical explanation of the Trigger Mechanism	35
Mode 3 Sensor Commands (Burst Mode).....	35
Error Codes for Plug-in card.....	36
Error Codes for Sensors.....	36
Return Sensor to Factory Defaults	37
Appendix A: Warranty	38
Scope and Duration of Warranties	38
Warranty Exclusions.....	39
Buyer's Remedies	39
Appendix B: EC Declaration of Conformity	41

Notes, Cautions, and Warnings



Note: Denotes helpful information intended to provide tips for better use of the product.



CAUTION: Denotes a hazard. Failure to follow instructions could result in minor personal injury and/or property damage. Included text gives proper procedures.



WARNING: Denotes a hazard. Failure to follow instructions could result in **SEVERE** personal injury and/or property damage. Included text gives proper procedures.

Safety Information



High Voltage: Indicates presence of hazardous voltage. Unsafe practice could result in severe personal injury or death.

OR



Protective Earth Ground (Safety Ground): Indicates protective earth terminal. You should provide uninterruptible safety earth ground from the main power source to the product input wiring terminals, power cord, or supplied power cord set.



Waste Electrical and Electronic Equipment (WEEE) Directive: (European Union) At end of useful life, this product should be deposited at an appropriate waste disposal facility for recycling and disposal. Do not dispose of with household waste.

1.0 Introduction

This manual contains information about EMPower™ products, namely the plug-in card and power sensors. Please read this manual carefully and make sure to pay special attention to the chapters regarding your new product(s).



The **ETS-Lindgren EMPower™ Meter Plug-in Card** for the EMCenter™ Modular RF Platform can control up to four EMPower sensors simultaneously. One EMCenter unit can contain up to eight EMPower cards, resulting in a maximum of 32 sensors per EMCenter. Alternatively, an EMPower sensor can be connected directly to a PC using a standard USB port and included software.

The **EMPower™ USB RF Power Sensor** is able to perform accurate power measurements with a high measurement speed at power levels close to the noise floor without the need for zero adjustment. It provides accurate measurements over a wide frequency range, which enables effective measurements in accordance with the latest EMC standards.

PRODUCT CHARACTERISTICS

The EMPower sensor excels at these features:

- **Ease of use** — The USB interface makes the EMPower sensor easy to use. Up to four sensors can be connected to a single EMPower card in an EMCenter Modular RF Platform.
- **High speed** — The unprecedented detector technology of the EMPower sensor enables extremely fast accurate power measurements, even at low power levels. EMC immunity measurements are time consuming. The total elapsed time depends on the number of frequency points, the dwell time, and the speed of the power meter. As the first two parameters are generally prescribed by standards, the only one that can be optimized is the speed of the power meter.

- **Accuracy** — The EMPower sensor allows high precision measurements with a large dynamic range. With a high accuracy of 0.25 dB over the complete band, the EMPower sensor is suitable for measurements in accordance with automotive, military, telecom, wireless, and EMC basic standards.
- **Low measurement uncertainties** — Impedance mismatches contribute to measurement uncertainty. The EMPower sensor has a low Voltage Standing Wave Ratio (VSWR) resulting in low measurement uncertainties compared to other contributions in EMC measurement setups.
- **CW Signals & RF Bursts** — To enable the measurement of RF bursts, the EMPower can also be delivered as a RF pulse power head. The pulse version of the EMPower is able to measure RF bursts as short as a few microseconds. The normal version of the EMPower only supports power measurements for CW signals.

NOTE: To achieve the required speeds for pulse measurements, the sensor needs to be directly connected to a PC USB 2.0 port with the supplied USB cable. TILE does not support pulse mode.

Standard Configuration

The standard configuration is an EMPower USB RF Power Sensor and a 2-meter cable. The Power sensor can be used together with the EMPower plug-in card or connected directly to a PC using a standard USB port and included software. Please specify the model of the sensor when ordering.

EMCENTER™ MODULAR RF PLATFORM

The properly configured Model 7002-001 EMCenter is required for operating the plug-in card, and is sold separately. Contact ETS-Lindgren for ordering information.



EMPOWER™ METER PLUG-IN CARD

The Model 7002-001 EMPower Plug-In Card is required for operating the sensor with the EMCenter, and is sold separately. Contact ETS-Lindgren for ordering information.



EMPOWER™ USB RF POWER SENSOR

This manual describes four of the five versions of the EMPower RF Power Sensors below. The differences between these models is the range that they cover and the measurements that they can perform. Power Sensor Model 7002-006 has its own separate manual available on the ETS-Lindgren website.

The Power sensor can be used together with the EMPower plug-in card or connected directly to a PC with a cable using a standard USB port and included software. Contact ETS-Lindgren for ordering information, and please specify model when ordering.

- **Model 7002-002** — Support RMS measurements for CW signals and covers the 9 kHz to 6 GHz range.
- **Model 7002-003** — Measure RF bursts as short as a few microseconds and covers the 9 kHz to 6 GHz range.
- **Model 7002-004** — Support RMS measurements for CW signals and covers the 80 MHz to 18 GHz range.
- **Model 7002-005** — Measure RF bursts as short as a few microsecond and covers the 80 MHz to 18 GHz range.



SHIELDED USB CABLE

The Shielded USB cable is required to use the RF Power Sensor. Contact ETS-Lindgren for ordering information.



Optional Configuration

Contact ETS-Lindgren for ordering information.

SOFTWARE

The EMPower may be controlled from a computer using these software products:

- ETS-Lindgren TILE!™ (Totally Integrated Laboratory Environment)
- ETS-Lindgren EMQuest™ Data Acquisition and Analysis Software
- Other test automation software

OTHER ITEMS

- Additional EMPower USB RF Power Sensors (please specify the model when ordering)
- IEEE Interface Card
- ISO 17025 Accredited Calibration for EMPower USB RF Power Sensor ordered

2.0 Maintenance



CAUTION: Before performing any maintenance, follow the safety information in the ETS-Lindgren *Product Information Bulletin* included with your shipment.



WARNING: Maintenance of the EMPower is limited to external components such as cables or connectors. If you have any questions concerning maintenance, contact ETS-Lindgren Customer Service.



To prevent electrical shock, do not remove cover. Always unplug the unit before starting maintenance, such as removing/inserting the plug-in cards.



If you have any questions concerning maintenance, contact ETS-Lindgren Customer Service.

Replacement and Optional Parts



Note: ETS-Lindgren may substitute a similar part or new part number with the same functionality for another part/part number. Contact ETS-Lindgren for questions about part numbers and ordering parts.

Following are the part numbers for ordering replacement or optional parts for the EMPower™ Meter Plug-In cards and power sensors.

Part Description	Part Number
EMPower Plug-in Card	<ul style="list-style-type: none">• Model 7002-002 — Plug-in card properly configured for sensor.
EMPower USB RF Power Sensor	<ul style="list-style-type: none">• Model 7002-002 — 9 kHz to 6 GHz range.• Model 7002-003 — 9 kHz to 6 GHz range.• Model 7002-004 — 80 MHz to 18 GHz range.• Model 7002-005 — 80 MHz to 18 GHz range.

Shielded USB Cable	<ul style="list-style-type: none">• Shielded USB Cable — 2m cable used with the power sensor.
--------------------	--

Service Procedures

CONTACTING ETS-LINDGREN



Note: Please see www.ets-lindgren.com for a list of ETS-Lindgren offices, including phone and email contact information.



Note: ETS-Lindgren is not responsible for service on equipment that has been configured with software other than what is provided by ETS-Lindgren. Support for such configurations requires a secondary charge from ETS-Lindgren.

SENDING A COMPONENT FOR SERVICE

For the steps to return a system or system component to ETS-Lindgren for service, see the *Product Information Bulletin* included with your shipment.

1. Contact ETS-Lindgren Customer Service to obtain a Service Request Order (SRO).
2. Briefly describe the problem in writing. Give details regarding the observed symptom(s) or error codes, and whether the problem is constant or intermittent in nature. Please include the date(s), the service representative you spoke with, and the nature of the conversation. Include the serial number of the item being returned.
3. Package the system or component carefully. If possible, use the original packing materials or carrying case to return a system or system component to ETS-Lindgren.

3.0 Specifications

EMPower™ Meter Plug-in Card Specifications (Model 7002-001)

PHYSICAL SPECIFICATIONS

Data Connector (Card side):	USB type A
Data Connector (Sensor side):	USB type B
Form Factor:	Occupies one slot in EMCenter
Max Number of Sensors per Card:	4

ENVIRONMENTAL SPECIFICATIONS

Relative Humidity:	10% to 90% (non-condensing)
Temperature Range (Operating):	0°C to 40°C (32°F to 104°F)
Temperature Range (Storage):	-20°C to 85°C (-4°F to 185°F)

ELECTRICAL SPECIFICATIONS

Communication:	USB 1.1
Power Consumption (mW):	Less than 200 mW
Supply Voltage:	Through EMCenter

EMPower™ USB RF Power Sensor (Models 7002-002 & -004)

PHYSICAL SPECIFICATIONS

Connector to Plug-in Card or PC (Data)	USB-B
USB Communication	USB 1.1
USB Power Consumption	< 200 mA
RF Input Connector	N-type Precision

ENVIRONMENTAL SPECIFICATIONS

Relative Humidity:	10% to 90% (non-condensing)
Temperature Range (Operating):	0°C to 40°C (32°F to 104°F)
Temperature Range (Storage):	-20°C to 85°C (4°F to 185°F)

ELECTRICAL SPECIFICATIONS

Model	7002-002	7002-004
Accuracy (23° ± 2° C)	0.25 dB	0.25 dB (≤ 10 GHz) 0.50 dB (> 10 GHz)
Calibrated Frequency Range	9 kHz to 6 GHz	80 MHz to 18 GHz
Detector Type	Diode	Diode
Input Damage Level	>20 dBm	>20 dBm
Maximum Linearity Error (0 dBm ref)	0.05 dB/10 dB	0.05 dB/10 dB
Measuring Speed (Per Second)	20K, 100K or 1 M	20K, 100K or 1 M
Measurement Function	RMS CW Power	RMS CW Power
Measurement Units	dBm	dBm
Power Measuring Range	-55 dBm to +10 dBm	-45 dBm to +10 dBm
Resolution	0.01 dB	0.01 dB
Temperature Effect	< 0.15 dB Over Full Temperature Range	< 0.15 dB Over Full Temperature Range
VSWR	<1.05 @ 10 MHz to 100 MHz <1.15 @ 100 MHz to 2 GHz <1.35 @ 2 GHz to 6 GHz	<1.20 @ 80 MHz to 10 GHz <1.35 @ 10 GHz to 18 GHz

EMPower™ USB RF Power Sensor (Models 7002-003 & -005)

PHYSICAL SPECIFICATIONS

Connector to Plug-in Card or PC (Data)	USB-B
--	-------

USB Communication	USB 1.1
USB Power Consumption	< 200 mA
RF Input Connector	N-type Precision

ENVIRONMENTAL SPECIFICATIONS

Relative Humidity:	10% to 90% (non-condensing)
Temperature Range (Operating):	0°C to 40°C (32°F to 104°F)
Temperature Range (Storage):	-20°C to 85°C (4°F to 185°F)

ELECTRICAL SPECIFICATIONS

Model	7002-003	7002-005
Accuracy (23° ± 2° C)	0.25 dB	0.25 dB (≤ 10 GHz) 0.50 dB (> 10 GHz)
Calibrated Frequency Range	9 kHz to 6 GHz	80 MHz to 18 GHz
Detector Type	Diode	Diode
Input Damage Level	>20 dBm	>20 dBm
Logging Buffer Record Mode	4,000 Samples 2,000 Pre-trigger 2,000 Post-trigger	4,000 Samples 2,000 Pre-trigger 2,000 Post-trigger
Maximum Linearity Error (0 dBm ref)	0.05 dB/10 dB	0.05 dB/10 dB
Measuring Speed (Per Second)	20K, 100K or 1 M	20K, 100K or 1 M
Measurement Function	Peak Power	Peak Power
Measurement Units	dBm	dBm
Power Measuring Range	-55 dBm to +10 dBm	-45 dBm to +10 dBm
Resolution	0.01 dB	0.01 dB
Temperature Effect	< 0.15 dB Over Full Temperature Range	< 0.15 dB Over Full Temperature Range

VSWR	<1.05 @ 10 MHz to 100 MHz <1.15 @ 100 MHz to 2 GHz <1.35 @ 2 GHz to 6 GHz	<1.20 @ 80 MHz to 10 GHz <1.35 @ 10 GHz to 18 GHz
------	---	--

4.0 EPower Plug-In Card Installation



CAUTION: Before connecting any components, follow the information provided in *Safety Information* on page v and in the *ETS-Lindgren Product Information Bulletin* included with your shipment.



Always unplug the unit before starting maintenance to prevent electrical shock. Maintenance includes removal of the plug-in cards or the top panel.



1. Determine in which empty slot of the EMCenter you want to install the EPower card. You may use slots 1 through 7, numbered from left to right as you look at the back of the EMCenter.

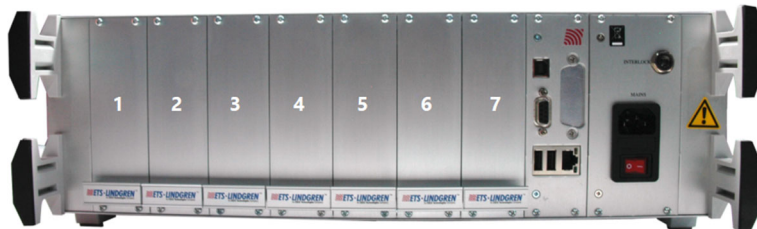

2. Remove the blank panel from the slot by removing the two screws at the top of the blank panel and the two screws at the bottom. Do not lose the screws.
3. Carefully insert the EPower card into the slot of the EMCenter. Reinsert and tighten the four screws.



Note: To allow the EMCenter time to accurately auto-detect, you must wait at least 10 seconds after connecting an EMPower sensor. Otherwise, this may result in incorrect power sensor detection. If this occurs, restart the EMCenter to allow re-detection of all connected power sensors.

4. Connect the Power Sensor to the EMPower card using the included USB cable. The EMCenter will automatically detect the EMPower sensor when it is connected to one of the four USB slots on the EMPower card.
5. The card installation is complete.

POWERING OFF

1. Go to the Home screen and press the OFF button located on the EMCenter screen.

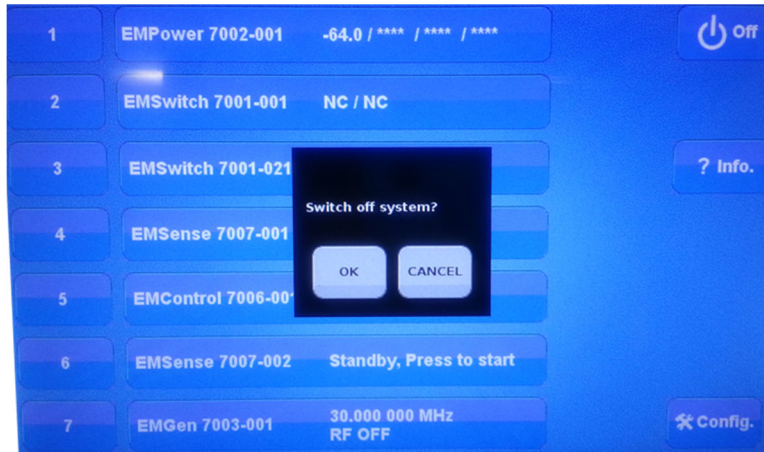

2. Press OK to switch off the system. The screen will go black and the standby light located on the front panel of the EMCenter will flash, and then will illuminate steadily.



Note: When the EMCenter is in standby mode, touch the screen anywhere to reboot.

3. To power down the EMCenter completely, flip the power switch located on the back panel of the EMCenter to the OFF position.
4. Remove the power cord from the power connector on the back panel of the EMCenter.



Access Sensor Settings

Once the EMCenter is ON, the EMPower card can be activated from the Home screen of the EMCenter touchscreen. The large status button on the Home screen will display any detected plug-in card and its sensor measurements as seen below. To monitor the measured power level(s), one can go to the Control screen by pressing the EMPower status button.

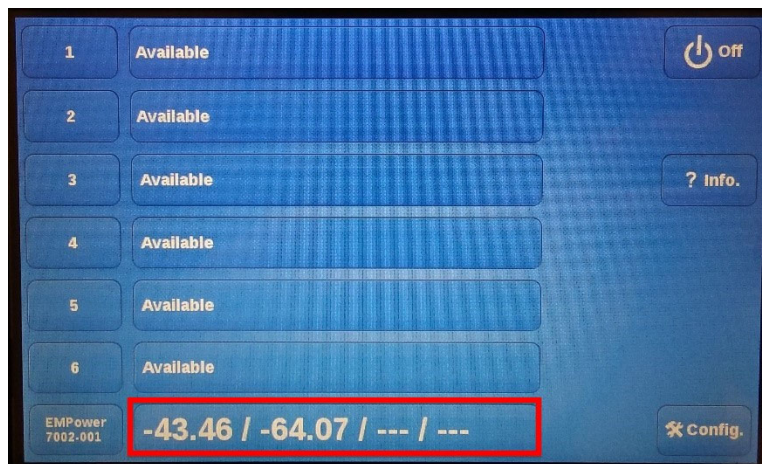

The user can change the frequency, filter, and offset settings on the Control screen. The operator can also use the pre-defined calculations gain, VSWR, and Net Power to calculate between two different power meter measurements; however, this function is only applicable for mode 0.

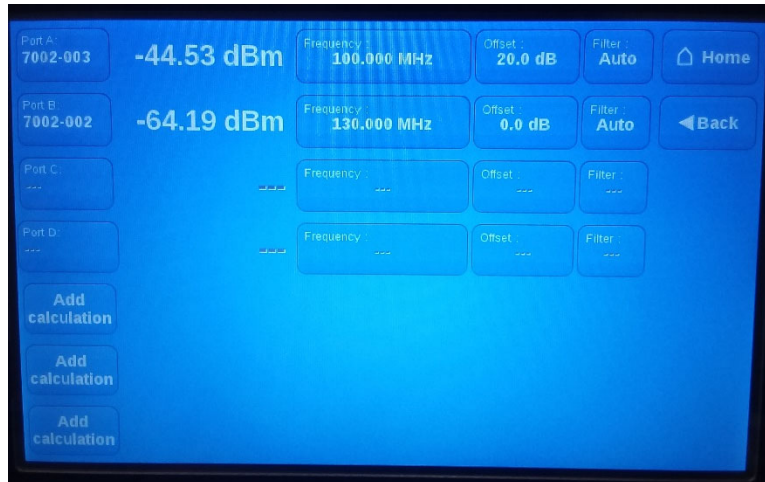

FREQUENCY

The frequency measurement is set to obtain the correct absolute power level. The frequency selection window will appear after pressing the frequency button. Input the desired number and select the unit to set the frequency setting. See the 'Command Set' section for more information about the FREQUENCY<n> command.

NOTE: If the user does not enter the correct measurement frequency, the power sensor will not display the correct absolute power level.

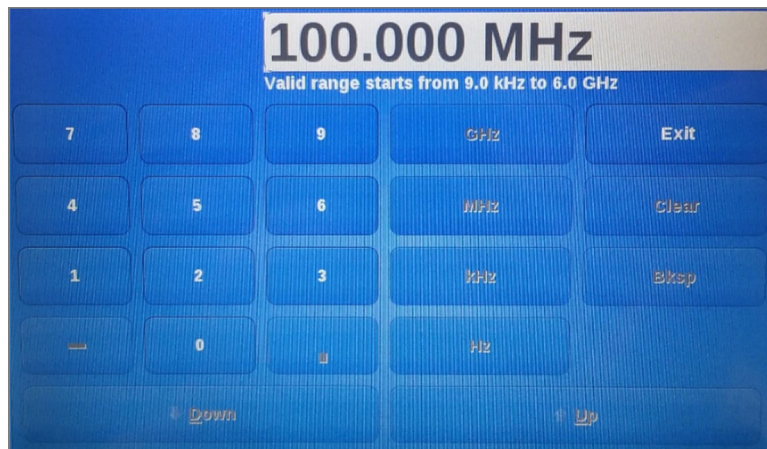

FILTER

The filter sets the number of samples used to calculate the RMS power value. The selection window will appear after pressing the filter button. Select the desired number to set the filter setting. See the 'Command Set' section for more information about the FILTER<n> command.

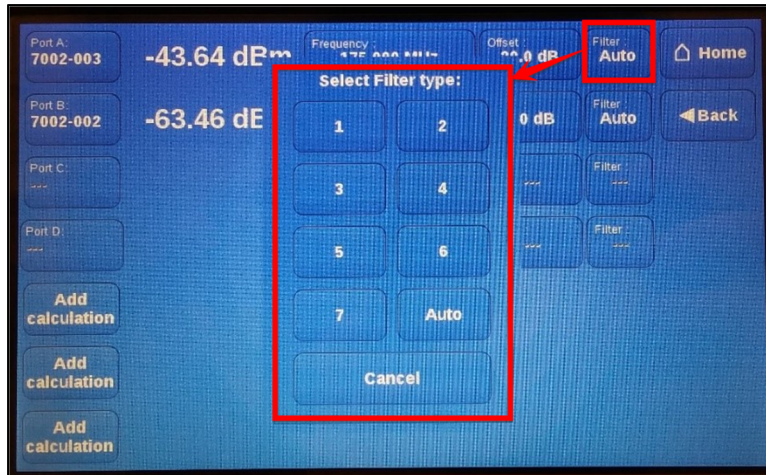

OFFSET

The offset is used to compensate for a fixed, known value such as 20 dB attenuation. The selection window will appear after pressing the offset button. Input the desired number and select dB to set the offset setting. The offset value will be added to the measured value of the EMPower. See the 'Command Set' section for more information about the `POWER_OFFSET<n>` command.

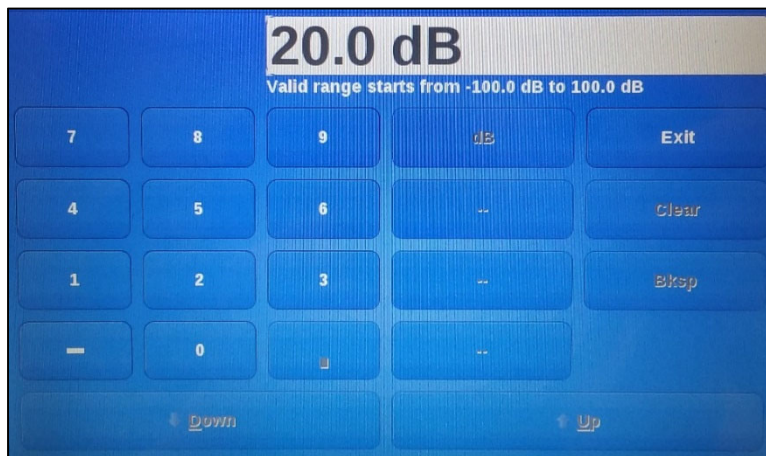

NET POWER

The Net power function calculates the logarithmic difference in dBm between the measured power of Input 1 and Input 2. This window will appear after pressing the Add Calculation button below the power sensor data. Select Net power and the inputs, then select OK. The Add Calculation button will change to Net power and the calculation result will appear next to it.

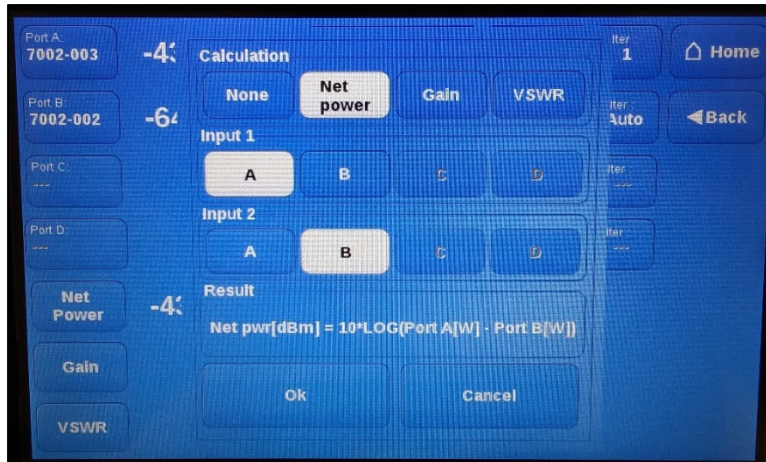

GAIN

The Gain function will calculate the difference in dBm between the measured power of Input 1 and Input 2. This window will appear after pressing the Add Calculation button below the power sensor data. Select Gain and the inputs, then select OK. The Add Calculation button will change to Gain and the calculation result will appear next to it.

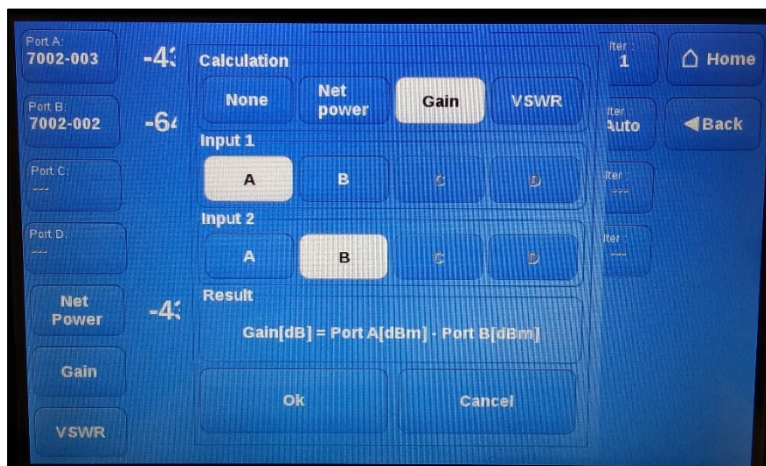

VSWR

The VSWR function will calculate the VSWR based on the measured forward power of Input 1 divided by the measured reflected power of Input 2. This window will appear after pressing the Add Calculation button below the power sensor data. Select VSWR and the inputs, then select OK. The Add Calculation button will change to VSWR and the calculation result will appear next to it.

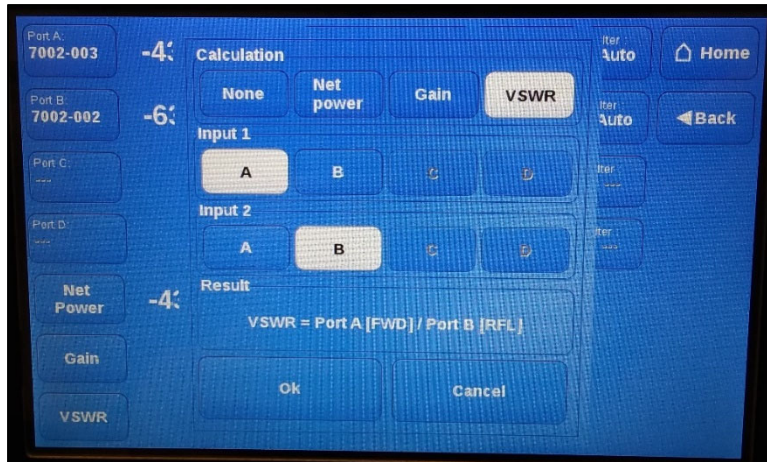

6.0 Computer Operation of Sensor

Stand alone terminal program controlled sensor

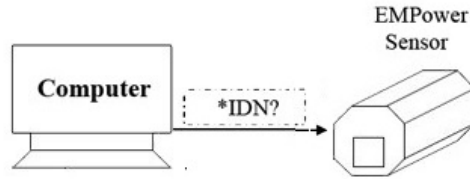

The EMPower sensor can be connected directly to a PC by communicating using a virtual COM-port (VCP). All 4 sensor modes can use this operation method; modes 2 and 3 only operate through a PC and not with the EMCenter.

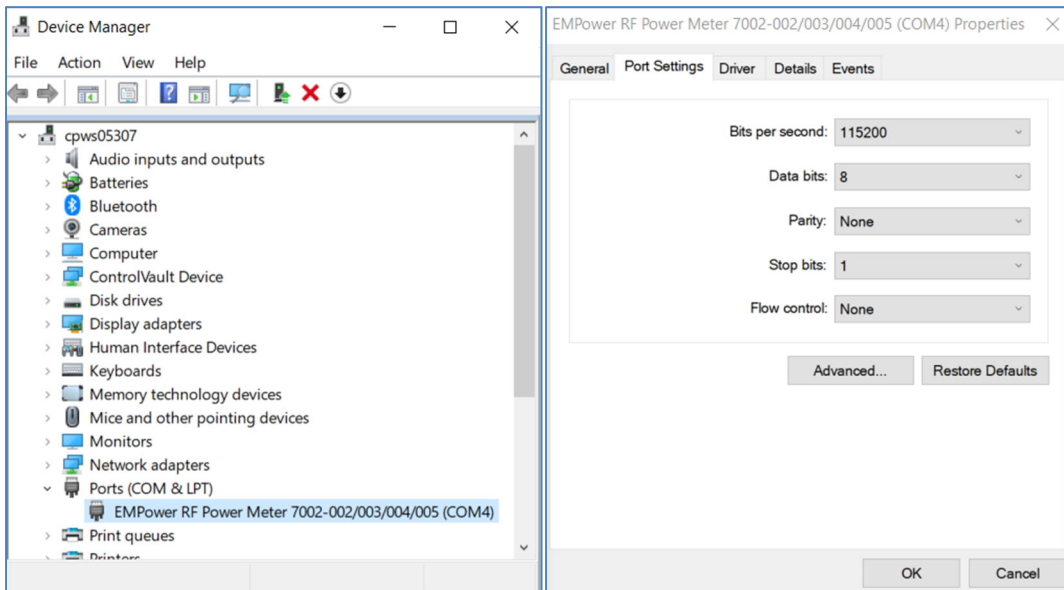

1. Open the Windows Control Panel and search for the Device Manager.
2. Once the device manager is open, connect the EMPower sensor to the computer's USB 2.0 compatible port with the supplied USB cable.
3. Once the cable is plugged into the computer, the EMPower sensor will be shown in the device list. A virtual COM-port (VCP) will be present in the list of Ports. This COM-port can be used to communicate with the EMPower using any terminal program.

TILE! controled sensor

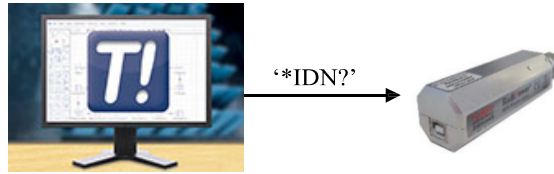

NOTE: TILE does not support pulse mode.

1. Connect the sensor either to the EMCenter or directly to the PC.
2. Open the TILE profile and create a new TILE! instrument.
3. On the driver tab, select the required EMPower device driver *ETS_EMPower.ins*.
 - a. If the sensor is connected to the EMCenter, go to the address tab and set the communication to VISA and set the Device ID (EMCenter Slot #) to match the slot of the EMPower card. Then on the settings tab, set the channel letter to match the port letter the sensor is plugged into.
 - b. If the sensor is directly connected to the PC, go to the address tab and set the communication to serial and set the correct COM-port. If you don't know what the COM-port is, see section *Stand Alone Sensor with PC*.
4. Select OK to save the settings.
5. Verify the instrument communication with the *IDN? command in the Instrument Interactive Control window (Hand icon on the TILE taskbar).

7.0 Command Set

The following tables in this section shows all available commands for the EMPower™ Meter Plug-in Card and the EMCenter RF sensors.



NOTE: Terminate each command with a carriage return (CR).



NOTE: If you receive an error code in response to a command, see page 36 for a list of error codes.

Syntax for EMCenter commands

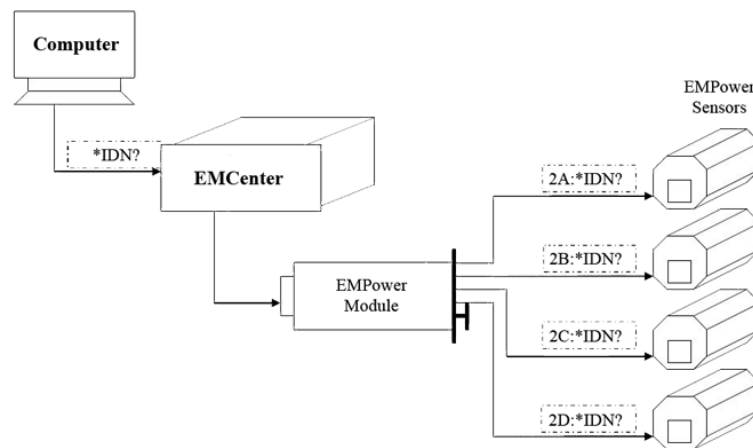

When controlling the EMPower sensor with an EMCenter, please note that each command must also include a device ID number as the prefix. See the EMCenter Modular RF Platform User Manual for complete information on device ID numbers.

For example, to query the filter setting of the EMPower sensor connected to port A of the EMPower card in slot 2, use the command:

Command = 2A:FILTER?

A = Board number of EMPower card

B = Port of the EMPower sensor

FILTER? = Message to EMPower sensor

- IEEE commands for Interface Clear and Clear are not supported and IEEE status flags in either serial or parallel poll or as a service request are not supported.
- When IEEE communication is used, the first command/request should be *IDN?\r.
- The default communication setting for the serial USB port is 115200,8,N,1.



NOTE: The prefix of the slot number and port letter only applies when the sensor is connected to an EMCenter. If the sensor is directly connected to the controlling computer, then do not add the prefix.

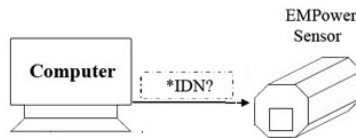

Description of Different Sensor Modes

The EMPower™ USB RF Power Sensor uses a high-performance demodulating logarithmic amplifier to detect the RF signal. The demodulated signal is sampled at high speed by a powerful DSP, which processes all samples. The burst/pulse versions of the EMPower sensors, 7002-003 and 7002-005, support these four modes of operation.

MODE 0: RMS POWER

Mode 0 is used to perform RMS power measurements of CW signals. In RMS mode, the EMPower sensor samples the demodulated signal at high speed up to a maximum of 10 Msps. The RMS value of the power is calculated over the number of samples defined by the filter setting and can be read by a simple command. Due to the high sampling speed, the number of readings is high even at large filter settings.

MODE 1: PEAK POWER

Mode 1 is used to perform peak measurements on RF signals. In peak mode, the EMPower sensor keeps track of the highest level that has been detected. This can be done for an infinite time. Once the power level has been read, the maximum value is automatically reset.

MODE 2: ENVELOPE TRACING

Mode 2 is used to capture the envelope of an RF signal. Envelope tracing is a unique feature that enables the possibility to visualize; for example, the in-rush phenomena of transmitters or signal generators without the need of an expensive RF analyzer. Due to the extensive trigger possibilities, almost any RF signal can be captured in the buffers of the EMPower sensor.

This mode is only available when the Power sensor is directly connected to the PC.

MODE 3: BURST LOGGING

Mode 3 is used to log RF bursts of frequency-hopping devices. For more complex transmitters like frequency-hopping devices, a special burst mode has been implemented. During the observation time, which can be up to 1 second at 1 Msps measurement speed, the time and RMS power of each RF burst is logged into memory. These measurements can be used to perform conducted measurements of RF output power according to new version of the ETSI EN 300 328 standard.

This mode is only available when the Power sensor is directly connected to the PC.

Commands for All Sensor Modes

In mode 0 (RMS mode), a new power measurement is started after the POWER? command is given. Depending on the filter setting, the EMPower sensor performs the required number of measurements and returns the RMS value.

For power measurements of AM modulated signals, acquisition speed, filter, and VBW settings are important to obtain accurate measurements. For example, if an AM modulated signal is to be measured with a modulation frequency of 1 kHz, the VBW should be set to 0, 1, 2, or AUTO. In general, the VBW should be 10 times smaller than the RF carrier frequency, but higher than the modulation frequency.

The acquisition speed and filter should be set in so that at least one full period of the modulation signal is measured. At 1 Msps, the filter should be set to 5 or higher, which results in 1000 or more samples. At lower sampling speeds (for example, 100 kps), the filter should be set to 3 or higher to measure at least one full period of the envelope signal.

In mode 1 (max hold) the POWER? command will return the highest value measured since the previous POWER? command. After reading the power, the stored value will be cleared.

In mode 2 (envelope tracing), temperature readings are not updated as long as the triggering is armed. While armed, temperature readings are still possible, but the actual values are taken before the measurement is armed. As soon as a trigger occurs, the temperatures are updated in the sensor.

Command	Response	Description
*IDN?	ETS-Lindgren, EMPower 7002-003, 2.60	Returns company, card model, and sensor software version
ID_NUMBER?	1.121.170.24.25.0.0.93	Request unique ID number of EMPower sensor
VERSION_SW?	2.60	Returns sensor software version
ACQ_SPEED <s> ¹	OK	Sets ADC sample speed in kSps: <s> = 20, 100, 1000, or 10000
ACQ_SPEED?	20, 100, 1000, or 10000	Returns ADC speed in kSps
AUTO_STORE <s>	OK	Sets the auto store mode: <0> = settings not automatically stored, default <1> = settings stored in flash after each change of the settings
AUTO_STORE?	0 or 1	Returns the current store setting
BURST?<NUM>	-12.34 - 12.35 dBm	Request multi measure power level in dBm; the number of measurements is requested in <NUM>
FILTER <n> ²	OK	Sets the number of samples used to calculate the RMS power value: <1> = 10 samples <2> = 30 samples <3> = 100 samples <4> = 300 samples <5> = 1000 samples <6> = 3000 samples <7 ³ > = 5000 samples
FILTER?	1, 2, 3, 4, 5, 6, 7, or AUTO	Returns the filter setting
FILTER AUTO	OK	Sets the filter to AUTO; the number of samples depends on the dBm range: +10 to -20 dBm = 100 samples -20 to -30 dBm = 300 samples -30 to -40 dBm = 1000 samples -40 to -50 dBm = 3000 samples below -50 dBm = 5000 samples
FREQUENCY <f> ⁴	OK	Set the frequency <f> in kHz

¹ Models 7002-002 and -004 can be set to 10 mSps in firmware versions higher than 2.7.0

² This setting only applies to mode 0

³ This setting only applies to model 7002-002

⁴ The frequency can be set at resolution 0.1 kHz in firmware versions higher than 2.4.x

FREQUENCY?	1300000 kHz	Returns the frequency in kHz
FREQUENCY? MAX	6000000 kHz	Returns the Highest measurable frequency
FREQUENCY? MIN	9 kHz	Returns the Lowest measurable frequency
MODE <m> ⁵	OK	Sets mode of sensor: <0> = RMS mode <1> = max hold, peak <2> = envelope tracing mode <3> = burst mode
MODE?	0, 1, 2, or 3	Returns current mode
POWER?	-63.84 dBm	Returns the measured power in dBm
POWER_OFFSET <p>	OK	Sets the power offset in dB: <p> = -100.00 to 100.00
POWER_OFFSET?	30.00	Returns the power offset in dB
POWER_UNIT <u> ⁶	OK	Sets the power units: <0> = dBm <1> = Watts
POWER_UNIT?	0 or 1	Returns the power unit
REBOOT SYSTEM	OK	Reboots the system / Restarts embedded software
RESET	OK	Resets the EMPower™ to default values; see Reset to Factory Defaults
STORE	OK	Stores the current settings in flash memory
TEMPERATURE? ⁷	307	Returns board temperature in 0.1 degrees Celsius. In this example: 30.7°C

⁵ This command only applies to models 7002-003 and -005

⁶ This command only applies to the *Power?* command in modes 0 and 1

⁷ Power measurements will be interrupted if a temperature reading is requested

VBW <n> ⁸	OK	<p>Sets Video bandwidth (VBW):</p> <p><0> = 10MHz <1> = 1MHz <2> = 200kHz <3> = 1kHz</p> <p>The VBW should be 10 times smaller than the lowest frequency to be measured.</p> <p>If a VBW has been set for mode 0, this will not affect the VBW setting for mode 1, 2, or 3, and vice versa. Each mode remembers its own VBW setting separate from the other modes.</p>
VBW?	0, 1, 2, 3, or AUTO	Returns the VBW setting
VBW AUTO	OK	<p>Set the VBW to automatic. The VBW is coupled to the sample speed of the power meter:</p> <p>10 MHz at 1 MSps 1 MHz at 100 kSps 200 kHz at 20 kSps</p>

Mode 2 Sensor Commands (Envelope Tracing Mode)

Command	Response	Description
ACQ_AUTO_TRIGGER <t>	OK	<p>Sets the trigger mode that should be used:</p> <p><1> = automatic (normal) triggering <0> = single triggering</p>
ACQ_AUTO_TRIGGER?	0 or 1	<p>Returns trigger mode.</p> <p>If auto trigger mode is set to 1, the power sensor will be automatically armed each time the data has been read from the device.</p>
ACQ_LOG_DATA?	Power values from buffer samples 0 to 1000	Returns log power values from buffer in dBm (ASCII text dump, values are separated by a “;”)
ACQ_LOG_DATA_ENH? <i>,<j>	Power values from buffer <i> samples before trigger to <j> samples after trigger	Returns log data from pre and/or post trigger buffer (text dump). Buffer sizes <i> and <j> can be 0 to 2000

⁸ This command only applies to models 7002-002 and -003

ACQ_LOG_DATA_ENH_BIN? <i>,<j>	Power values from buffer <i> samples before trigger to <j> samples after trigger	Returns log data from pre and/or post trigger buffer (binary dump, 2 byte integer *100) special code 0x7777 represents data start, 0xAAAA represents data end
ACQ_LOG_DELAY <d>	OK	Sets number of samples that a trigger will be delayed after the measurement is armed. <d> = 0 to 2000000
ACQ_LOG_DELAY?	0 to 2000000	Returns number of samples that searching for a trigger will be delayed after first occurring trigger
ACQ_LOG_MAX?	-9.97 dBm	Returns the highest power value in dBm recorded in buffers
ACQ_LOG_RESET	OK	Resets (clears) the sample buffers and arms the envelope trace measurement to wait for the next valid trigger
ACQ_LOG_STATUS?	0 or 1	0 = waiting for trigger 1 = buffers filled
ACQ_LOG_THRESHOLD <l>	OK	Sets the trigger level to power level <l> in dBm
ACQ_LOG_THRESHOLD?	-40.00; 12345	Returns trigger level; second value is an internal level for debug purposes
ACQ_LOG_TRIGGER <a>,,<c>	OK	Sets trigger mode: <a> = 0 for Edge triggering or 1 for Level triggering (During edge trigger the distance between two samples is 10, during level trigger the distance between to samples is 1) = 0 for Falling edge or 1 for Rising edge <c> = 1 to 100 for number of samples used to evaluate edge or level trigger
ACQ_LOG_TRIGGER?	0 or 1; 0 or 1; 1 to 100	Returns Trigger mode: <a> = mode = rising/falling edge <c> = trigger filter

ACQ_LOG_TRIG_DIST <d>	OK	Sets the distance between two consecutive samples for detecting rising or falling edge (d=1 to100). This command is only used for debugging. Default distance is 10 samples. VALUE will not be stored in flash memory.
ACQ_LOG_TRIG_HOLDOFF <d>	OK	Sets number of samples that a trigger will be held off after first occurring trigger. If a trigger occurs during the hold off period, the counter will be reset. <d> = 0 to 1000000
ACQ_LOG_TRIG_HOLDOFF?	0 to 1000000	Returns number of samples that trigger will be held off after first occurring trigger

RESPONSE TIMES FOR DATA READOUT MODE 2 - ENVELOPE TRACING

In mode 2, several commands can be used to read the data from the buffers of the EMPower™. The following table shows the approximate time for the data transfer at 115200 bps.

Command	Time	Description
ACQ_LOG_DATA?	720 ms	Read power values from buffer samples 0 to 1000 in ASCII text.
ACQ_LOG_DATA_ENH? <i>,<j>	720ms for i=j=500 1425ms for i=j=1000 2850ms for i=j=2000	Read power values from buffer <i> samples before trigger to <j> samples after trigger in ASCII text.
ACQ_LOG_DATA_ENH_BIN? <i>,<j>	180ms for i=j=500 360ms for i=j=1000 720ms for i=j=2000	Read power values from buffer <i> samples before trigger to <j> samples after trigger in binary format.

GRAPHICAL EXPLANATION OF THE TRIGGER MECHANISM

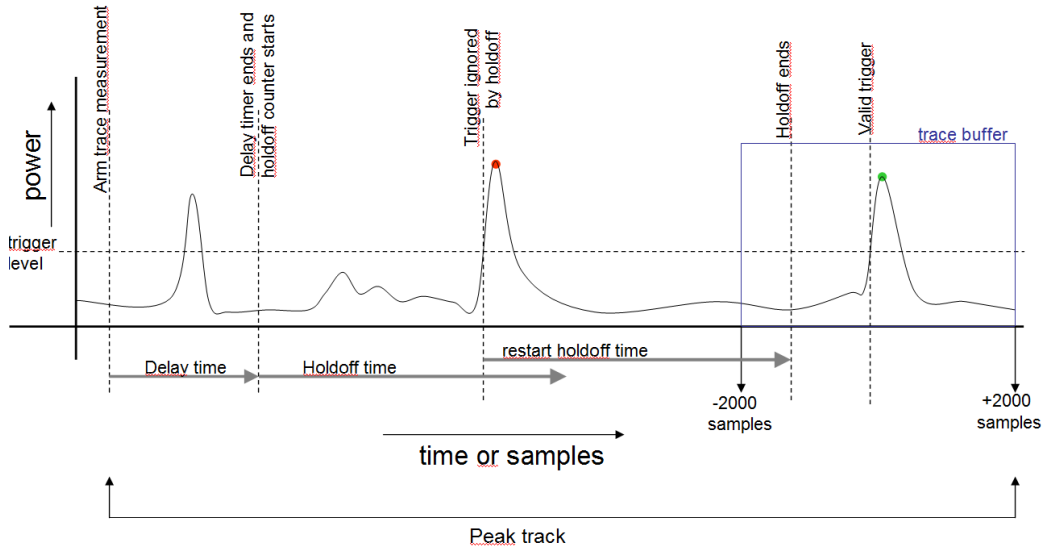

During tracing mode, the peak value will be tracked and stored in memory from the moment the measurement is armed. The peak value can be read by using the ACQ_LOG_MAX? command, which will also reset the peak value once it has been read.

Peak track will stop as soon as a valid trigger has been found and the buffers are ready to be read from the device (ACQ_LOG_STATUS=1).

A high number of samples for the DELAY or HOLDOFF command at low sampling rates results in long measurement times up to 100 seconds.

Mode 3 Sensor Commands (Burst Mode)

Command	Response	Description
BM_BURST_COUNT?	252	Returns number of bursts found within the set measurement period. The maximum number is 800
BM_BURST_DATA?<i>	x;y;z or NO DATA	Returns for burst with number <i> the start time (x); end time (y); RMS power (z). Final character is a new line.
BM_BURST_DATA_DUMP	x;y;z or NO DATA	Returns for each burst within the measurement period the start time (x); end time (y); RMS power (z). Final character is a new line.
BM_GO	OK	Starts a single burst measurement
BM_MEASURE_PERIOD <T>	OK	Sets measurement period: T=1 to 1000 ms

BM_MEASURE_PERIOD?	500	Returns the measurement period
BM_NOISE_TIMER <n>	OK	Sets number of samples allowed below threshold before a new burst is counted: n = 0 to 5000 samples
BM_NOISE_TIMER?	10	Returns number of samples set
BM_STAT?	0 or 1	Returns status of burst measurement: 0 = measurement not started or in progress 1 = measurement completed and data is ready to be read
BM_TRIG_LEVEL <l>	OK	Sets trigger level for burst detection: l = -70 to +12 dBm
BM_TRIG_LEVEL?	-40	Returns trigger level in dBm

Error Codes for Plug-in card

Error code	Description
ERROR_1	Wrong Command
ERROR_50	Wrong Argument
ERROR_51	Argument too High
ERROR_52	Argument too Low
ERROR_601	Frequency not set
ERROR_602	Over range
ERROR_603	Under range
ERROR_604	No Cal data

Error Codes for Sensors

Error code	Description
ERROR_1	Wrong Command
ERROR_50	Wrong Argument
ERROR_51	Argument too Low
ERROR_52	Argument too High
ERROR_601	Frequency not set
ERROR_602	Over range
ERROR_603	Under range
ERROR_604	No Cal data

Return Sensor to Factory Defaults

Command	Default	Description
ACQ_AUTO_TRIGGER	0	Single trigger
ACQ_LOG_DELAY	0	No delay time before trigger
ACQ_LOG_THRESHOLD	-40.0	-40 dBm
ACQ_LOG_TRIG_HOLDOFF	0	No hold off before trigger.
ACQ_LOG_TRIGGER	0; 1; 2	Rising edge triggering; sample; sample
ACQ_SPEED	1000	1 Msps
AUTO_STORE	0	Parameter changes will not be stored automatically
BM_MEASURE_PERIOD	1000	1000 ms
BM_NOISE_TIMER	10	10 samples
BM_TRIG_LEVEL	-40	-40 dBm
FILTER	AUTO	Automatic filter setting
FREQUENCY	1300000 kHz	1300 MHz
MODE	0	RMS power measurement
VBW (mode 0)	3	1kHz VBW in RMS mode for CW signals
VBW (mode 1, 2, and 3)	AUTO	Automatic VBW setting for all other modes

Appendix A: Warranty

Scope and Duration of Warranties

Seller warrants to Buyer that the Products to be delivered hereunder will be (1) free from defects in material, manufacturing workmanship, and title, and (2) conform to the Seller's applicable product descriptions and specifications, if any, contained in or attached to Seller's quotation. If no product descriptions or specifications are contained in or attached to the quotation, Seller's applicable product descriptions and specifications in effect on the date of shipment shall apply. The criteria for all testing shall be Seller's applicable product specifications utilizing factory-specified calibration and test procedures and instruments.

All product warranties, except the warranty of title, and all remedies for warranty failures are limited to three years.

Product Warranted	Duration of Warranty Period
EMPower™ Meter Plug-In Card	3 Years
EMPower™ USB RF Power Sensor	3 Years

Any product or part furnished to Buyer during the warranty period to correct a warranty failure shall be warranted to the extent of the unexpired term of the warranty applicable to the repaired or replaced product.

The warranty period shall commence on the date the product is delivered to Buyer; however, if Seller assembles the product, or provides technical direction of such assembly, the warranty period for such product shall commence on the date the assembly of the product is complete. Notwithstanding the foregoing, in the event that the assembly is delayed for a total of thirty (30) days or more from the date of delivery for any reason or reasons for which Seller is not responsible, the warranty period for such product may, at Seller's options, commence on the thirtieth (30th) day from the date such product is delivered to Buyer. Buyer shall promptly inspect all products upon delivery. No claims for shortages will be allowed unless shortages are reported to Seller in writing within ten (10) days after delivery. No other claims against Seller will be allowed unless asserted in writing within thirty (30) days after delivery (or assembly if the products are to be assembled by Seller) or, in the case of alleged breach of warranty, within the applicable warranty period.

Warranty Exclusions

Except as set forth in any applicable patent indemnity, the foregoing warranties are exclusive and in lieu of all other warranties, whether written, oral, express, implied, or statutory. EXCEPT AS EXPRESSLY STATED ABOVE, SELLER MAKES NO WARRANTY, EXPRESS OR IMPLIED, BY STATUTE OR OTHERWISE, WHETHER OF MERCHANTABILITY OR FITNESS FOR ANY PARTICULAR PURPOSE OR USE OR OTHERWISE ON THE PRODUCTS, OR ON ANY PARTS OR LABOR FURNISHED DURING THE SALE, DELIVERY OR SERVICING OF THE PRODUCTS. THERE ARE NO WARRANTIES WHICH EXTEND BEYOND THE DESCRIPTION ON THE FACE HEREOF.

Warranty coverage does not include any defect or performance deficiency (including failure to conform to product descriptions or specifications) which results, in whole or in part, from (1) negligent storage or handling of the product by Buyer, its employees, agents, or contractors, (2) failure of Buyer to prepare the site or provide an operating environmental condition in compliance with any applicable instructions or recommendations of Seller, (3) absence of any product, component, or accessory recommended by Seller but omitted at Buyer's direction, (4) any design, specification, or instruction furnished by Buyer, its employees, agents or contractors, (5) any alteration of the product by persons other than Seller, (6) combining Seller's product with any product furnished by others, (7) combining incompatible products of Seller, (8) interference with the radio frequency fields due to conditions or causes outside the product as furnished by Seller, (9) improper or extraordinary use of the product, or failure to comply with any applicable instructions or recommendations of Seller including maintenance, calibration and cleaning procedures and intervals, or (10) acts of God, acts of civil or military authority, fires, floods, strikes or other labor disturbances, war, riot, or any other causes beyond the reasonable control of Seller.

This warranty does not include (1) batteries, (2) cables, (3) gasket, (4) fingerstock, or any item that is designed to be consumable. Seller does not warranty products of others which are not included in Seller's published price lists.

Buyer's Remedies

If Seller determines that any product fails to meet any warranty during the applicable warranty period, Seller shall correct any such failure by either, at its option, repairing, adjusting, or replacing without charge to Buyer any defective or nonconforming product, or part or parts of the product. Seller shall have the option to furnish either new or exchange replacement parts or assemblies.

Warranty service shall be performed at the Seller's factory, or the Buyer's site at the sole discretion of the Seller. Within the warranty period, the Buyer shall be responsible for all transportation to the Seller's factory, and the Seller shall be responsible for transportation of goods to the Buyer's site.

Within the contiguous 48 United States, warranty service performed during the applicable warranty period will be performed without charge to Buyer during Seller's normal business hours. After the warranty period, service will be performed at Seller's prevailing service rates. Subject to the availability of personnel, after-hours service is available upon request at an additional charge.

Outside the contiguous 48 United States, travel and per diem expenses, when required, shall be the responsibility of the Buyer, or End User, whichever is applicable regardless of the warranty period.

The remedies set forth herein are conditioned upon Buyer promptly notifying Seller within the applicable warranty period of any defect or non-conformance and making the product available for correction.

The preceding paragraphs set forth Buyer's exclusive remedies and Seller's sole liability for claims based on failure of the products to meet any warranty, whether the claim is in contract, warranty, tort (including negligence and strict liability) or otherwise, and however instituted, and, upon the expiration of the applicable warranty period, all such liability shall terminate. IN NO EVENT SHALL SELLER BE LIABLE TO BUYER FOR ANY SPECIAL, INDIRECT, INCIDENTAL OR CONSEQUENTIAL DAMAGES OF ANY KIND ARISING OUT OF, OR AS A RESULT OF, THE SALE, DELIVERY, NON-DELIVERY, SERVICING, ASSEMBLING, USE OR LOSS OF USE OF THE PRODUCTS OR ANY PART THEREOF, OR FOR ANY CHARGES OR EXPENSES OF ANY NATURE INCURRED WITHOUT SELLER'S WRITTEN CONSENT DESPITE ANY NEGLIGENCE ON BEHALF OF THE SELLER. IN NO EVENT SHALL SELLER'S LIABILITIES UNDER ANY CLAIM MADE BY BUYER EXCEED THE PURCHASE PRICE OF THE PRODUCT IN RESPECT OF WHICH DAMAGES ARE CLAIMED. This agreement shall be construed in accordance with laws of the State of Texas. In the event that any provision hereof shall violate any applicable statute, ordinance, or rule of law, such provision shall be ineffective to the extent of such violation without invalidating any other provision hereof.

Any controversy or claim arising out of or relating to the sale, delivery, non-delivery, servicing, assembling, use or loss of use of the products or any part thereof or for any charges or expenses in connection therewith shall be settled in Austin, Texas by arbitration in accordance with the Rules of the American Arbitration Association, and judgment upon the award rendered by the Arbitrator may be entered in either the Federal District Court for the Western District of Texas or the State District Court in Austin, Texas, all of the parties hereto consenting to personal jurisdiction of the venue of such court and hereby waive the right to demand a jury trial under any of these actions.

Appendix B: EC Declaration of Conformity

ETS-Lindgren Inc. declares these products to be in conformity with the following standards, following the provisions of EMC Directive 2004/108/EC:

EMPower™ Meter Plug-in Card

EMPower™ USB RF Power Sensor

Emission: EN 61326 1:2006, Class B

Electrical equipment for measurement, control, and laboratory use.

Immunity: EN 61326 1:2006, Industrial level, performance criteria A

Electrical equipment for measurement, control, and laboratory use.

Technical Construction Files are available upon request.