

*Model 8100-045*  
**RF Power Amplifier**  
**User Manual**



ETS-Lindgren Inc. reserves the right to make changes to any products herein to improve functioning or design. Although the information in this document has been carefully reviewed and is believed to be reliable, ETS-Lindgren does not assume any liability arising out of the application or use of any product or circuit described herein; nor does it convey any license under its patent rights nor the rights of others. All trademarks are the property of their respective owners.

© Copyright 2014–2016 by ETS-Lindgren Inc. All Rights Reserved. No part of this document may be copied by any means without written permission from ETS-Lindgren Inc.

Trademarks used in this document: The *ETS-Lindgren* logo is a registered trademark and *Calibration Services Plus!* is a trademark of ETS-Lindgren Inc.

### Revision Record

MANUAL,8100-045 | Part #399659, Rev. A

Revision	Description	Date
A	Initial Release	December, 2016

# Table of Contents

<b>Notes, Cautions, and Warnings</b> .....	<b>vi</b>
<b>Safety Information</b> .....	<b>vi</b>
<b>1.0 Introduction</b> .....	<b>7</b>
Standard Configuration .....	8
Optional Items .....	8
Rack Mount Brackets.....	8
<b>2.0 Maintenance</b> .....	<b>9</b>
Maintenance Recommendations .....	9
Troubleshooting .....	9
Replacement and Optional Parts.....	11
Service Procedures .....	11
Contacting ETS-Lindgren.....	11
Sending a Component for Service .....	11
Calibration Services .....	11
<b>3.0 Specifications</b> .....	<b>13</b>
Electrical Specifications.....	13
Physical Specifications .....	13
<b>4.0 Before You Begin</b> .....	<b>15</b>
Setting up the Amplifier .....	15
Rack Mounting .....	15
<b>5.0 Pre-Installation Tasks</b> .....	<b>17</b>
Mains Connection .....	17
RF Connectors .....	17
Interlock Safety Loop.....	17
<b>6.0 Operation</b> .....	<b>19</b>
Front Panel View .....	19
Rear Panel View .....	20
Manual Operation.....	21
Remote Control via the IEC/IEEE-488.2 GPIB Interface .....	25
Setting the GPIB Instrument Address .....	26
Interface Messages.....	26
Device Messages.....	27
Remote Control via the Ethernet Interface .....	30
Administration by LAN .....	31
Ethernet Control Commands.....	35
Status Messages of the Amplifier in Ethernet Remote Control Mode.....	36

Remote Control and Interlock Interface .....	37
<b>Appendix A: Warranty .....</b>	<b>39</b>
Scope and Duration of Warranties .....	39
Warranty Exclusions.....	40
Buyer's Remedies .....	40
<b>Appendix B: EC Declaration of Conformity .....</b>	<b>43</b>

# List of Figures

Figure 1:	Amplifier block diagram.....	8
Figure 2:	Pin assignment of remote control and interlock connector.....	17
Figure 3:	Example of interlock safety loops.....	18
Figure 4:	Front panel view .....	19
Figure 5:	Rear panel view .....	20
Figure 6:	User Menu .....	23
Figure 7:	Pin assignment of IEEE connector.....	25
Figure 8:	IEEE universal commands.....	26
Figure 9:	IEEE addressed commands.....	26
Figure 10:	ASCII/ISO and IEC character set.....	27
Figure 11:	IEEE interface commands .....	28
Figure 12:	IEEE interface status messages .....	29
Figure 13:	Pin configuration of the Ethernet interface .....	30
Figure 14:	Ethernet interface commands .....	35
Figure 15:	Ethernet interface status messages.....	36
Figure 16:	Signals at the remote control and interlock connector.....	37

## Notes, Cautions, and Warnings

---



**Note:** Denotes helpful information intended to provide tips for better use of the product.



**CAUTION:** Denotes a hazard. Failure to follow instructions could result in minor personal injury and/or property damage. Included text gives proper procedures.



**WARNING:** Denotes a hazard. Failure to follow instructions could result in SEVERE personal injury and/or property damage. Included text gives proper procedures.

## Safety Information

---



**Refer to Manual:** When product is marked with this symbol, see the instruction manual for additional information. If the instruction manual has been misplaced, download it from [www.ets-lindgren.com](http://www.ets-lindgren.com), or contact ETS-Lindgren Customer Service.



**High Voltage:** Indicates presence of hazardous voltage. Unsafe practice could result in severe personal injury or death.



**Protective Earth Ground (Safety Ground):** Indicates protective earth terminal. You should provide uninterruptible safety earth ground from the main power source to the product input wiring terminals, power cord, or supplied power cord set.



**Waste Electrical and Electronic Equipment (WEEE) Directive:** (European Union) At end of useful life, this product should be deposited at an appropriate waste disposal facility for recycling and disposal. Do not dispose of with household waste.

## 1.0 Introduction

---

The **ETS-Lindgren Model 8100-045 RF Power Amplifier** can deliver an output power of 100 W over the frequency range of 1000 MHz to 6000 MHz.

The seven-stage solid-state amplifier is of modular design and integrated into two RF modules, both featuring a high linearity and a flat frequency response.

In order to achieve a stable output power, the bias of the amplifier stages are controlled by low-drift voltage regulators.

The maximum input power for achieving the nominal output power is 0 dBm corresponding to 1 mW or 0.224 V into 50  $\Omega$ . Due to its gain reserve, the amplifier usually achieves full output power with an input power of -5 dBm.

The final stage is separately protected against overload by current limitation. The amplifier is protected against open circuit and short circuit at the output. By using suitable transistors and a special circuit design in the final stage, even a total mismatch at the output will not cause any damage. For a VSWR  $\leq$  2:1 the maximum power can be obtained, all specifications being met.

The amplifier housing is designed to ensure minimum RF leakage and high RF immunity. The module is supplied with DC voltage via RF feed through filters.

In order to protect the amplifier against thermal overload in case the blower fails or the ambient temperature is too high, a temperature sensor is mounted on the heat sink in the vicinity of the final stage.

## Standard Configuration

---

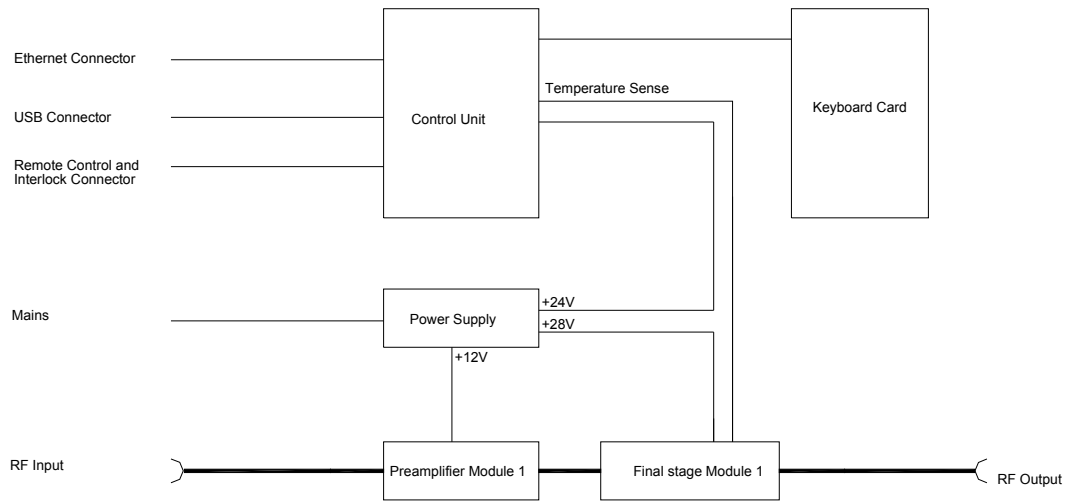

**Figure 1: Amplifier block diagram**

## Optional Items

---

### RACK MOUNT BRACKETS

Set of two brackets for fixing the amplifier in standard 19" racks.



## 2.0 Maintenance

---



**CAUTION:** Before performing any maintenance, follow the information provided in *Safety Information* on page vi.



**WARNING:** Maintenance of this power amplifier is limited to external components such as cables or connectors. If you have any questions concerning maintenance, contact ETS-Lindgren Customer Service.



Clean the exterior of the cabinet using a damp cloth and mild cleaner. Always unplug the unit before cleaning.

To prevent electrical shock, do not remove cover.



Warranty may be void if the housing is opened.

If you have any questions concerning maintenance, contact ETS-Lindgren Customer Service.

### Maintenance Recommendations

---

In general, the amplifier does not require any maintenance due to its solid-state amplifier design and overrating of all components under thermal stress.

The fans have a lifetime  $\geq 40,000$  h; this results in a lifetime of 5 years even with permanent operation.

Cleaning and care of the RF connectors are to be performed according to the regulations valid for N-series connectors. All mechanical and electrical specifications are guaranteed for at least 500 plug-in cycles.

### Troubleshooting

---

If the green control light inside the mains switch does not light after turning mains on, please check the following.

No response after switching the mains switch on:

Check the fuses at the line input at the rear panel of the amplifier.  
Check the mains voltage at the mains connector.

If a fault message will be displayed, the following should be checked:

Display: Interlock External

Check the connection to the external interlockswitch or jumper in the interlock

connector (see Figure 2 on page 17 and Figure 3 on page 18).

Display: Temperature X

Check whether the airflow is obstructed.  
Check if the internal blower works.  
Check if the ambient temperature is more than +45 °C.  
Allow the instrument to cool down and try to start again.  
Check if the Fault message persists.

Display: PowerSupply X

Fault of one or more output voltages of the indicated power supply X.  
Switch off the amplifier and try to start again.  
Check if the Fault message persists.

Display: TTL or GPIB or LAN

Press the Control key until the display indicates LOCAL. The amplifier can now be activated locally.

If a non-permanent error message is being displayed it has to be confirmed by pushing the Standby/Operate key at the front panel before the fault status will be unlatched.

## Replacement and Optional Parts

---



**Note:** ETS-Lindgren may substitute a similar part or new part number with the same functionality for another part/part number. Contact ETS-Lindgren for questions about part numbers and ordering parts.

## Service Procedures

---

### CONTACTING ETS-LINDGREN



**Note:** Please see [www.ets-lindgren.com](http://www.ets-lindgren.com) for a list of ETS-Lindgren offices, including phone and email contact information.

### SENDING A COMPONENT FOR SERVICE

1. Contact ETS-Lindgren Customer Service to obtain a Service Request Order (SRO).
2. Briefly describe the problem in writing. Give details regarding the observed symptom(s) or error codes, and whether the problem is constant or intermittent in nature. Please include the date(s), the service representative you spoke with, and the nature of the conversation. Include the serial number of the item being returned.
3. Package the system or component carefully. If possible, use the original packing materials or carrying case to return a system or system component to ETS-Lindgren.

### CALIBRATION SERVICES

- **Annual Calibration**—For reliable and repeatable long-term performance, annual recalibration of your measuring device by an ETS-Lindgren experienced technician is recommended. The ETS-Lindgren calibration team will calibrate most any type or brand of measuring device. Additional information is available at [www.ets-lindgren.com/calibration](http://www.ets-lindgren.com/calibration).
- **Calibration Services Plus!™**—Calibration Services Plus! is a customized, optional program to help you expertly maintain your test and measurement assets. It is designed to address the challenges of managing the calibration and repair of test and measurement components, including scheduling and planning to ensure peak performance. Additional information is available at [www.ets-lindgren.com/maintenance](http://www.ets-lindgren.com/maintenance).

This page intentionally left blank.

### 3.0 Specifications

---

#### Electrical Specifications

---

<b>Frequency range</b>	1000-6000 MHz
<b>Output power</b>	100 W cw min.
<b>Gain</b>	50 dB min.
<b>Input power</b>	0 dBm max. to get nominal output power +10 dBm max. for no damage
<b>Harmonics</b>	-15 dBc min. (2 <sup>nd</sup> ), -20 dBc min. (3 <sup>rd</sup> )
<b>Spurious</b>	-50 dBc min.
<b>AC supply</b>	100 VAC to 240 VAC, ±10% 47 Hz to 63 Hz
<b>Line power</b>	950 VA
<b>RF connectors (input/output)</b>	N-f, on rear panel
<b>Impedance (input/output)</b>	50 Ohms
<b>VSWR (input/output)</b>	2:1 typ.
<b>Load VSWR</b>	Infinite for no damage
<b>Remote control interfaces</b>	GPIO, LAN, TTL

#### Physical Specifications

---

<b>Dimensions (WxHxD)</b>	430 mm x 133 mm(3 HU) x 630 mm 16.9 in x 5.2 in x 24.8 in
<b>Weight</b>	25 kg (56 lb)
<b>Ambient temperature</b>	0°C to +45°C (+32°F to +113°F)
<b>Storage temperature</b>	-20°C to +85°C (-4°F to +185°F)
<b>Humidity</b>	95% max. (non condensing)
<b>Vibration and shock</b>	Acc. MIL-STD 810F
<b>Altitude</b>	7000 ft above sea level

This page intentionally left blank.

## 4.0 Before You Begin

---



**CAUTION:** Before connecting any components, follow the information provided in *Safety Information* on page vi.

### Setting up the Amplifier

---

When setting up the amplifier, make sure that the cooling airflow is impeded neither at the air inlet at the front nor at the outlet at the rear. The permissible operating temperature ranges from +0°C to +45°C with an air humidity of max. 95%. The outlet air temperature exceeds the inlet temperature by max. 20°C.



**CAUTION:** The temperature of the inlet cooling air must not exceed +45°C. The outlet air temperature should be maximum 20°C higher than the inlet air temperature.

### Rack Mounting

---

To ensure sufficient ventilation:

- Make sure to provide enough space between the casing and the air inlet at the front panel and the air outlet at the rear.
- Make sure that there is sufficient air supply inside the rack (forced ventilation) and that no overheating can occur due to other instruments placed under or over the amplifier.



**CAUTION:** The temperature of the inlet cooling air must not exceed +45°C.

This page intentionally left blank.



## 5.0 Pre-Installation Tasks

---



**CAUTION:** Before connecting any components, follow the information provided in *Safety Information* on page vi.

### Mains Connection

---

The amplifier is equipped with a power supply which can be operated at a voltage of 100–240 VAC. The automatic line fuse (2x 12 A T) is integrated in the mains switch.



**Note:** When connecting the amplifier to the AC mains network, make sure to provide a proper protective earth connection according to the regulations.

### RF Connectors

---

The amplifier is equipped with N-type female connectors at all RF connectors. The mating connectors must be tightened manually.

### Interlock Safety Loop

---

This amplifier permits an interlock safety loop to be connected, which must be always closed for activating the amplifier. The interlock function protects the user against unintentional emission of RF power.

It is necessary to wire the attached mating connector for the Remote Control and Interlock connector at the rear panel of the instrument as shown below. Pin 8 and pin 15 should be connected to the safety loop of the measuring room.

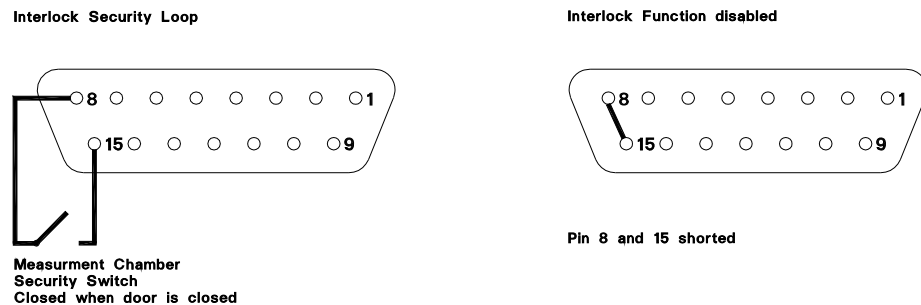
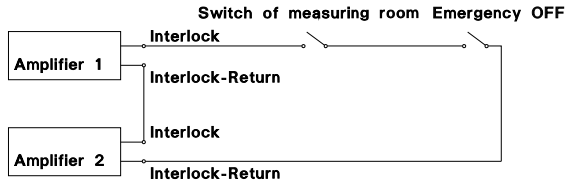

**Figure 2: Pin assignment of remote control and interlock connector**

This ensures that the amplifier can only be switched on when the safety switch, and thus the door of the measuring room, is closed.

The EXTERNAL INTERLOCK and EXTERNAL INTERLOCK RETURN contacts are designed as floating ones. In this way more than one amplifier can be interconnected in an interlock system with a common switch or a common loop.

**Example of instruments with floating contacts**



**Example of instruments with floating contacts which are referred to ground**

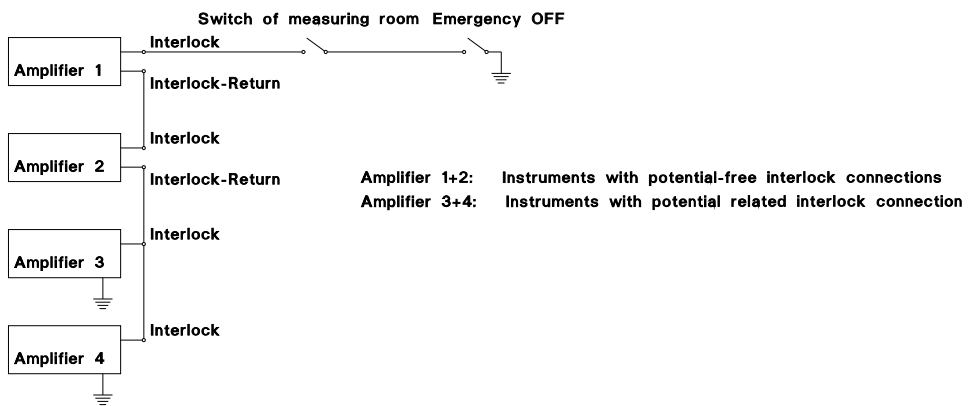

**Figure 3: Example of interlock safety loops**

If this safety function is not used after thorough examination, the interlock contact can be bridged in the Remote Control and Interlock connector. This is done using a jumper from EXTERNAL INTERLOCK pin 8 to EXTERNAL INTERLOCK RETURN pin 15.



**Note:** If the interlock connection is missing, the amplifier cannot be operated.

Finally, check that there is no message indicating an interlock error status on the display. Now the amplifier is ready for use and can be operated either manually via the front panel or via one of the remote control interfaces.

## 6.0 Operation



**CAUTION:** Before placing into operation, follow the information provided in *Safety Information* on page vi.



**Note:** Make sure you are satisfied with the contents and condition of your system prior to placing it into operation.

### Front Panel View

Figure 4: Front panel view

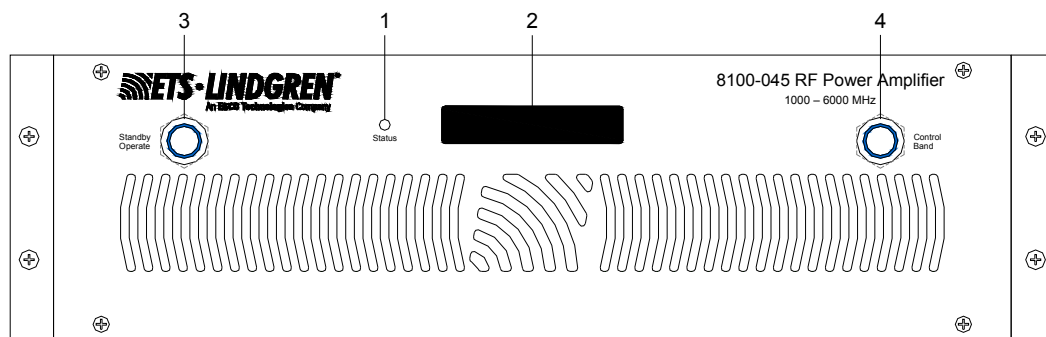

1	STATUS LED	LED is illuminated when a fault occurs, which shuts down the amplifier
2	DISPLAY	Status Display
	Amplifier Status	See chapter 6, <i>Operation</i> , on page 19
	Fault Indications	See chapter 2, <i>Maintenance</i> , on page 9
	Type of amplifier	Indication of amplifier model number
	Elapsed time meter	Indication of hours in operation
	GPIB-Address	Setting of the GPIB-address
3	STANDBY/OPERATE KEY	Key for switching the amplifier on/off
	Display: OPERATE	RF switched on (amplifier active)
	Display: STANDBY	RF switched off (amplifier in standby)

4	CONTROL/BAND KEY	Key for switching to local control mode Key for switching the amplifier band
	Display: LOCAL	Front panel control enabled
	Display: GPIB	IEEE 488.2 GPIB remote control enabled
	Display: LAN	Ethernet remote control enabled
	Display: TTL	TTL remote control enabled
	Display: BAND x	Band x is selected

## Rear Panel View

**Figure 5: Rear panel view**

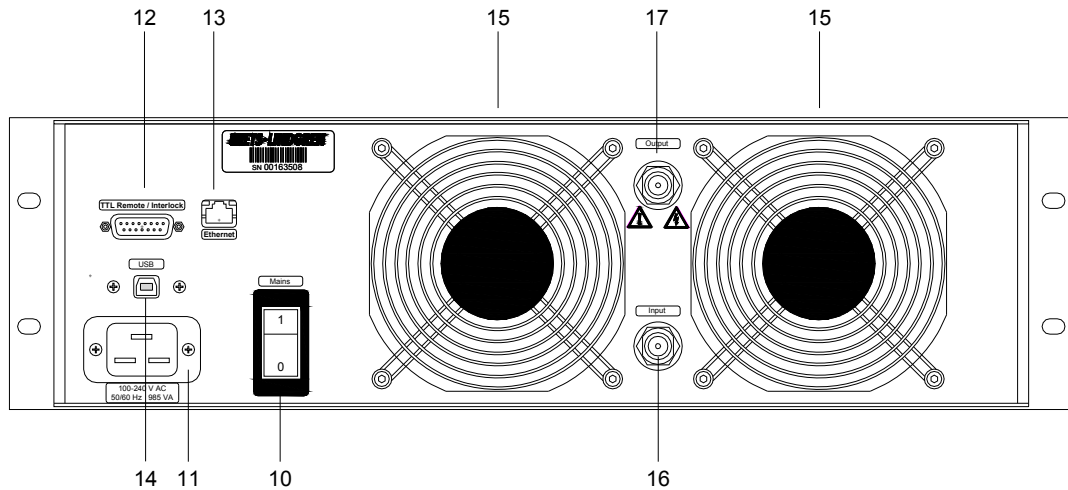

10	MAINS SWITCH	Illuminated when mains is switched on
11	MAINS RECEPTACLE	AC power plug with fuse holders
12	REMOTE CONTROL AND INTERLOCK CONNECTOR	Connector for interlock loop and the standard remote control interface
13	ETHERNET CONNECTOR	Ethernet remote control interface
14	USB-CONNECTOR	USB interface connector
15	FANS	
16	RF INPUT	RF-input connector
17	RF OUTPUT	RF-output connector

Press the MAINS switch to turn on the amplifier.

The MAINS switch is illuminated. Only the main control board is supplied and the turn-on procedure of the instrument is executed.

The model number will be shown in the power up screen on the display (Screen P).

After 2 seconds the amplifier will change the display to its main screen (Screen M).

The amplifier is now in standby and in the local control mode (Display:LOCAL).

In this state the amplifier offers a user menu, which allows viewing miscellaneous diagnostic parameters of the instrument and allows adjusting of the IEEE address.

The following description refers to **Figure 6: User Menu** on a page 23 which gives an overview of the user menu pages:

From the main screen, the user menu can be accessed by pushing the left and the right button simultaneously for at least one second.

The first page of the user menu is the voltage and current page (Screen V).

- It is primarily intended for diagnostics (e.g. during checking or service) and shows the actual voltage and current values of all the internal power supply output channels of the instrument.
- By clicking the left or right button the previous or next supply channel can be monitored.
- Exit the voltage and current page by pushing the left and the right button simultaneously for at least one second.

The second page of the user menu is the amplifier identification screen (Screen I).

- This screen shows the type and serial number of the amplifier (same as the remote control command “\*IDN?” will respond).
- Exit the amplifier identification page by pushing the left and the right button simultaneously for at least one second.

The third page of the user menu is the elapsed time meter screen (Screen E).

- This screen shows the overall amount of time that the amplifier has been in operation mode (OPERATE) and the amount of RF switch on cycles. The display format is “Total Hours:Minutes:Seconds (Cycles)”.
- You can change between the elapsed time meter for “Mains on”, the elapsed time meter for “OPERATE” and (if applicable) the elapsed time meters for “OPERATE in each frequency band” by pushing the right button or the left button (to step back).
- Exit the elapsed time meter page by pushing the left and the right button simultaneously for at least one second.

The fourth screen of the user menu is the GPIB/IEEE address screen (Screen G).

- This screen allows viewing and changing of the current GPIB/IEEE address of the amplifier.
- The address is changed via clicking the left or right button.
- The address ranges from 01 to 31 and the default address is 07.
- Exit the GPIB/IEEE address page by pushing the left and the right button simultaneously for at least one second.

After exiting the fourth user menu page the amplifier will show the main screen (Screen M) again.

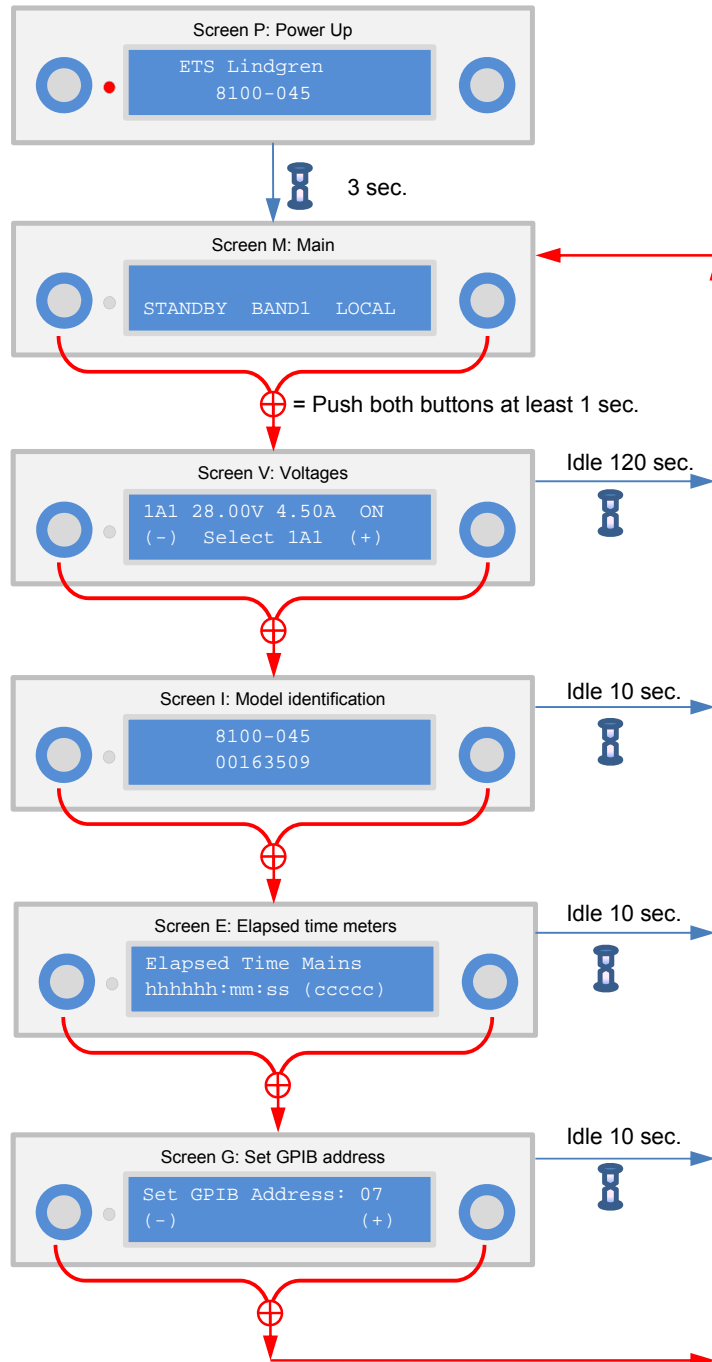

**Figure 6: User Menu**

For safety reasons, the amplifier includes an interlock function as standard. Any occurring error is indicated on the front panel in the display.



**Note:** The amplifier can not be activated from the front panel or via the remote control interfaces as long as an interlock error is signaled.

Connect RF generator and RF power load to the amplifier using RF cables (tighten connectors accordingly).



**CAUTION:** The maximum permissible input power is **+10 dBm (0.707 V)**. The amplifier already provides the nominal output power at typically **-5 dBm**.

Press the Standby/Operate key.

- The STANDBY text in the display changes to OPERATE.
- If the interlock loop is interrupted during operation, the amplifier is deactivated automatically. The error message Interlock External will be displayed. If the door and thus the safety switch are closed again, the amplifier is not activated again automatically but must be activated via the front panel or via one of the remote control interfaces.
- After a measurement has been concluded, the amplifier can be deactivated by pressing the Amplifier key again. RF OFF will be shown at the display. For removal of the internal heat the fan can be operating for about one more minute.



**CAUTION:** If the amplifier is driven outside its frequency range, no damage is caused; however, only the signal component (e.g. harmonics of generator), which lies within the frequency range of the amplifier, is amplified.

**In this case, measuring the output power does not provide any information on the actual operation of the instrument.**



## Remote Control via the IEC/IEEE-488.2 GPIB Interface

The instrument is equipped with an IEC-Bus connection. The connector according to IEEE 488 is located at the rear panel of the instrument. This interface can be used to connect a controller for remote control purposes. The connection must be made using a shielded cable.

Characteristics of the IEC/IEEE.2 GPIB interface:

- 8 bit parallel data transfer
- Bidirectional data transfer
- Three wire handshake
- High data transfer rate
- Up to 15 instruments can be connected
- Maximum length of interconnection cables 15 m (each single connection 2 m)

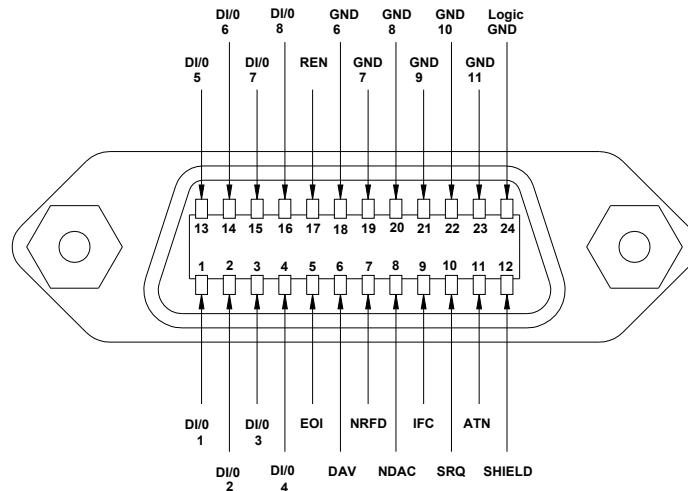

**Figure 7: Pin assignment of IEEE connector**

On power on, the amplifier is always in the local state (manual operation). At the front panel display LOCAL will be indicated.

If a controller addresses the amplifier as a listener by sending the REMOTE command, the amplifier changes to the remote state and remains in this state even after termination of data transmission. This is indicated by the message GPIB at the front panel display.

A change of the control mode is only possible when the amplifier is in STANDBY mode.

There are two methods to return to the local state:

- By the controller command "Go To Local" (GTL).
- By pressing the Control key on the front panel of the amplifier.

## SETTING THE GPIB INSTRUMENT ADDRESS

The IEEE bus address (GPIB address) of the amplifier will be shown and can be changed within the user menu. Please refer to page 22 for details.

The valid address range is from 01 to 31. Other settings are not permissible. The address set is immediately taken over after an alteration.

Upon delivery of the instrument, address 07 is set.

## INTERFACE MESSAGES

Interface messages are transferred by the controller to a device via eight data lines, the ATN line remaining active, i.e. low. Only an active controller is able to issue interface messages. A distinction is made between universal commands and addressed commands.

Universal commands are effective for all the devices connected to the IEEE-488 GPIB-bus without previous addressing.

Command	Function
DCL (Device Clear)	Aborts processing of the currently received commands and resets the command processing software to a defined initial status. This command does not affect the device settings.

**Figure 8: IEEE universal commands**

Addressed commands act only on devices that have been addressed as listeners by the controller before.

Command	Function
SDC (Selected Device Clear)	Aborts processing of the currently received commands and resets the command processing software to a defined initial status. This command does not affect the device settings.
*RST	Reset

**Figure 9: IEEE addressed commands**

A device remains addressed to listen until it is unaddressed by the controller.

Control Characters					Numbers and Characters				Upper-case letters				Lower-case letters				
0	Nul		16	DLE		32	SP	48	0	64	@	80	P	96	`	112	p
1	SOH		17	DC1		33	!	49	1	65	A	81	Q	97	a	113	q
2	STX		18	DC2		34	~	50	2	66	B	82	R	98	b	114	r
3	ETX		19	DC3		35	#	51	3	67	C	83	S	99	c	115	s
4	EOT	SDC	20	DC4	DCL	36	\$	52	4	68	D	84	T	100	d	116	t
5	ENQ		21	NAK		37	%	53	5	69	E	85	U	101	e	117	u
6	ACK		22	SYN		38	&	54	6	70	F	86	V	102	f	118	v
7	BEL		23	ETB		39	'	55	7	71	G	87	W	103	g	119	w
8	BS		24	CAN		40	(	56	8	72	H	88	X	104	h	120	x
9	HT		25	EM		41	)	57	9	73	I	89	Y	105	i	121	y
10	LF		26	SUB		42	*	58	:	74	J	90	Z	106	j	122	z
11	VT		27	ESC		43	+	59	;	75	K	91	[	107	k	123	{
12	FF		28	FS		44	,	60	<	76	L	92	\	108	l	124	
13	CR		29	GS		45	-	61	=	77	M	93	]	109	m	125	}
14	SO		30	RS		46	.	62	>	78	N	94	^	110	n	126	~
15	SI		31	US		47	/	63	?/UNL	79	O	95	-	111	o	127	DEL
Addressed Commands			Universal Commands			Listener Address			Talker Address			Secondary Addresses and Commands					

Figure 10: ASCII/ISO and IEC character set

## DEVICE MESSAGES

Device messages (to IEC 625-1) are transmitted on the data lines, in which case the ATN line is not active, i.e. high. The ASCII code (ISO 7-bit code) is used.

### Commands Received by the Amplifier in Listener Mode (Controller to Device Messages)

The ASCII code (ISO 7-bit code) is used. All commands to the amplifier consist of a single character set followed by the "Line feed" character (hexadecimal: 0A; decimal: 10) as a terminator.

All commands to the amplifier must be terminated by a terminator. The only permissible terminator is:

<Line feed> (ASCII code 10 decimal)

A command line may require more than one line on the screen of the controller because it is only limited by the terminator. Most controllers automatically append a terminator to the transmitted data.

The following command sequences result from this:

Function	Command (String)
Go to remote	REMOTE
Go to local	LOCAL
Amplifier on (Operate)	AMP_ON
Amplifier off (Standby)	AMP_OFF
Amplifier on/off status	AMP?
Amplifier identification	*IDN?
Amplifier reset	*RST
Control status	CONTROL?

**Figure 11: IEEE interface commands**

### **Messages Sent by the Amplifier in Talker Mode (Device to Controller Messages)**

The amplifier transmits messages via the IEEE-488.2 GPIB-bus if it has been requested by a query command to provide data in its output buffer and has been addressed as talker.

Note that the command line with the data requests must be transmitted immediately before addressing as talker. The output buffer is cleared if another command line is entered in between.

### **Transferring the Device Status**

The status messages of the amplifier indicated at the display on the front panel are transferred as a text via the IEEE-488.2 GPIB interface to the controller. For this purpose, the status text must be polled first (see control character sequence above). The text can then be transmitted in a standard reading process. The amplifier transfers the text also with "Line feed" as the terminator.

The status messages indicated on the front panel are encoded in the status text according to the following table:

Query	Status message (String)	Meaning
*IDN?	ETS, 8100-045, xxx	Instrument identification: Manufacturer, Model number, Serial number
AMP?	AMP_ON	Amplifier is set to operate mode
	AMP_OFF	Amplifier is set to standby mode
CONTROL?	LOCAL	Amplifier is in local control mode
	GPIB	Amplifier is in GPIB control mode
	LAN	Amplifier is in LAN control mode
	TTL	Amplifier is in TTL control mode
STATUS?	SYSTEM_OK	Amplifier is working normally
	Interlock External	External Interlock fault
	Temperature X	Over temperature fault at sensor X
	PowerSupply X	Power supply fault at output X
	Control Fault	Internal control fault

**Figure 12: IEEE interface status messages**

## Alarms

If a fault status occurs, the amplifier indicates the specific fault message and sends a service request via the IEEE interface. The controller is able to recognize this alarm message without having to poll the status byte of the amplifier repeatedly.

To reset the fault message the command \*RST has to be sent to the amplifier.

The alarm message has to be acknowledged by way of the serial poll procedure specified in the IEEE-488.2 GPIB standard (see interface manual of the controller). The status byte issued by the amplifier corresponds to the above-mentioned status messages.

## Remote Control via the Ethernet Interface

---

The instrument is equipped with a LAN interface. The RJ45 connector is located at the rear panel of the instrument. This interface can be used to connect a controller for remote control purposes. The connection must be made using a shielded cable.

RJ-45-Connector female (EIA/TIA 568A)		
1	TX+	Transmitted data high
2	TX-	Transmitted data low
3	RX+	Receive data high
4		(not used)
5		(not used)
6	RX-	Receive data high
7		(not used)
8		(not used)

**Figure 13: Pin configuration of the Ethernet interface**

On power on, the amplifier is always in the local state (manual operation). At the front panel display LOCAL will be indicated.

If a controller addresses the amplifier as a listener by sending the REMOTE command, the amplifier changes to the remote state and remains in this state even after termination of data transmission. This is indicated by the message LAN at the front panel display.

A change of the control mode is only possible when the amplifier is in STANDBY mode.

There are two methods to return to the local state:

- By the command LOCAL.
- By pressing the Control key on the front panel of the amplifier.

## ADMINISTRATION BY LAN

**Default IP Address of the Ethernet Interface is 192.168.1.253,  
subnet mask 255.255.255.0**

This IP address can be changed to any desired address according to your network configuration. To be able to perform such change of the IP address, a computer with matching IP settings has to be connected directly to the amplifier.

To do this the LAN adapter settings of the control computer must be temporarily changed.

### Computer Configuration

Configure the control computer with:

IP address            192.168.1.xxx  
where xxx is 001 or any number between 1 and 252  
subnet mask        255.255.255.0

Check that the computer is connected to same Ethernet LAN than the Ethernet interface of the amplifier.

Then call the amplifier's settings page via the browser (see the following screen shots), and change the amplifier's IP settings to your desired network configuration.

After that, you can set your computer's LAN adapter settings back to the original settings.

### TCP/IP Configuration

IP address of each Ethernet interface must be unique on the network. An individual address can be either assigned by:

- A static address using administrative commands, or
- An existing DHCP server on the network, who can assign an available address.

If both DHCP and static IP address are defined, DHCP configuration will override static IP.

Only one new Ethernet interface can be plugged on the LAN at a given time, until an individual IP address is assigned on each Ethernet interface. Otherwise conflicts will be caused.

## TCP/IP Configuration Setup

Open the web browser.

Enter the IP address of the Ethernet interface (e.g. <http://192.168.1.253>).

Enter the user and password (8 digits).

The default user name is "user" and the default password is "admin00"

Then the following page will display:

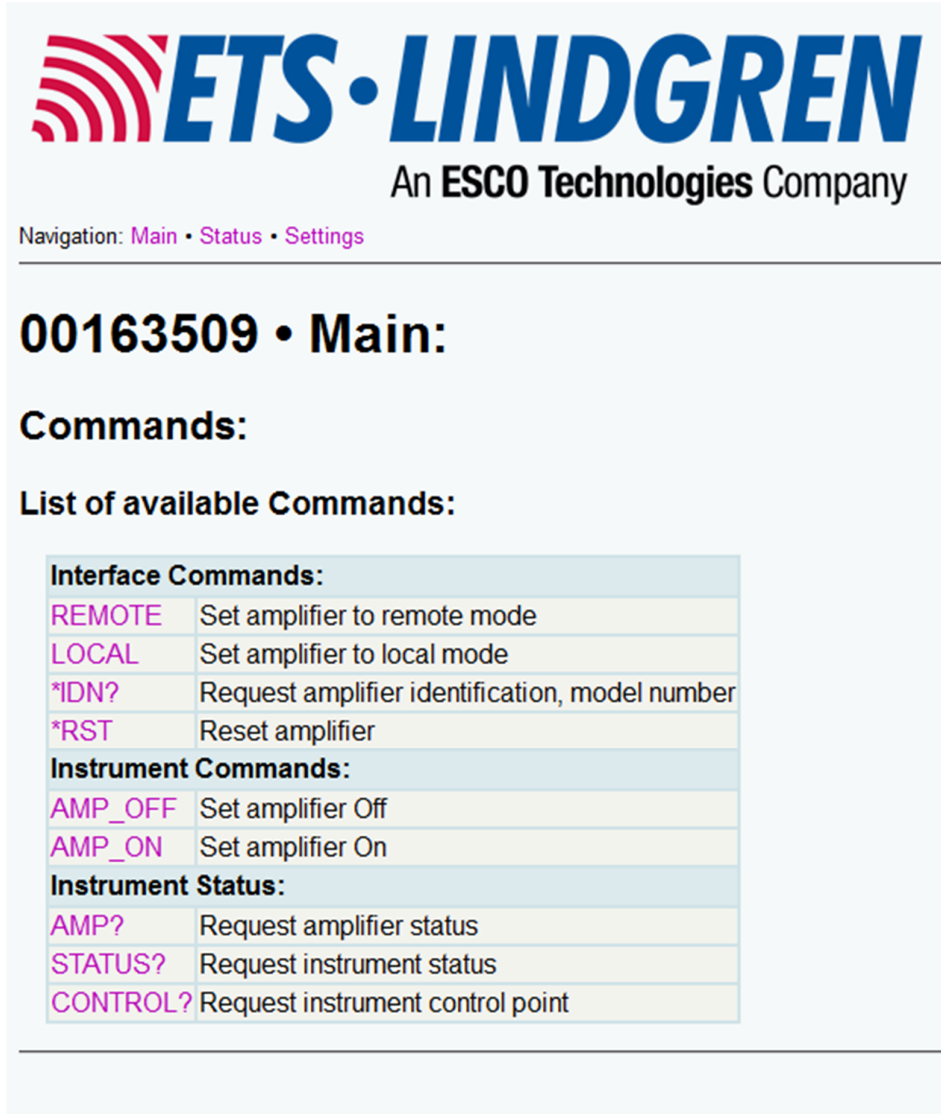

The screenshot shows the ETS-LINDGREN web interface. At the top is the logo for ETS-LINDGREN, with the text "An ESCO Technologies Company" below it. A navigation bar contains links for "Main", "Status", and "Settings". The main content area displays "00163509 • Main:" followed by "Commands:". Below this is a section titled "List of available Commands:" which contains a table of commands categorized into Interface Commands, Instrument Commands, and Instrument Status.

Interface Commands:	
REMOTE	Set amplifier to remote mode
LOCAL	Set amplifier to local mode
*IDN?	Request amplifier identification, model number
*RST	Reset amplifier
Instrument Commands:	
AMP_OFF	Set amplifier Off
AMP_ON	Set amplifier On
Instrument Status:	
AMP?	Request amplifier status
STATUS?	Request instrument status
CONTROL?	Request instrument control point

Select "Status" to get basic information about the actual amplifier status.

Then the following page will display:





An ESCO Technologies Company

Navigation: [Main](#) • [Status](#) • [Settings](#)

## 00163509 • Status:

<b>Amplifier status:</b>	AMP_OFF
<b>Instrument Status:</b>	SYSTEM_OK
<b>Control Point:</b>	LOCAL
<b>VCP Connection:</b>	disconnected
<b>Web Connection:</b>	192.168.1.79

• •

[Stop Status Refresh](#)

[Status View for legacy Browsers](#)

Select "Network- and Password-Settings", and the following page will display:

## 00163509 • Network- and Password-Settings:

### TCP/IP- and Virtual Com Port Settings:

Hostname:	<input type="text" value="00163509"/>
Use DHCP:	<input type="checkbox"/>
IP-Address:	<input type="text" value="192.168.1.253"/>
Netmask:	<input type="text" value="255.255.255.0"/>
Gateway:	<input type="text" value="192.168.1.1"/>
Nameserver:	<input type="text" value="192.168.0.1"/>
VCP TCP-Port:	<input type="text" value="2500"/>
<input type="button" value="Apply"/>	

### Change Web-Login:

Username:	<input type="text"/>
Password:	<input type="password"/>
<input type="button" value="Apply"/>	

Set IP address, network mask, gateway or alternatively select DHCP and confirm settings by "OK".

Before setting the amplifier's IP settings to DHCP, please make sure that you have a DHCP server running in your LAN, and you can find out the IP address, that the DHCP server assigned to your amplifier. If you are not sure, do not use DHCP.

The system will return to the previous page ("Device Commands") from where the instrument can be fully controlled.

## ETHERNET CONTROL COMMANDS

The ASCII code (ISO 7-bit code) according to Figure 10 of this manual is used. All commands to the amplifier consist of a single character set followed by the "Line feed" character (hexadecimal: 0A; decimal: 10) as a terminator.

All commands to the amplifier must be terminated by a terminator. The only permissible terminator is:

<Line feed> (ASCII code 10 decimal)

Between each two commands there should be a delay time of 200 ms to avoid a command overflow situation.

The following command sequences result from this:

Function	Command (String)
Go to remote	REMOTE
Go to local	LOCAL
Amplifier on (Operate)	AMP_ON
Amplifier off (Standby)	AMP_OFF
Amplifier on/off status	AMP?
Amplifier identification	*IDN?
Amplifier reset	*RST
Control status	CONTROL?
Amplifier status	STATUS?

**Figure 14: Ethernet interface commands**

## STATUS MESSAGES OF THE AMPLIFIER IN ETHERNET REMOTE CONTROL MODE

The amplifier will return a status information if it is requested to do so by a data poll command.

The status messages which are indicated on the front panel display can also be transmitted as status information via the Ethernet remote control interface to the control computer.

The status messages indicated on the front panel are encoded in the status text according to the following table:

Query	Status message (String)	Meaning
*IDN?	ETS, 8100-045, xxx	Instrument identification: Manufacturer, Model number, Serial number
AMP?	AMP_ON	Amplifier is set to operate mode
	AMP_OFF	Amplifier is set to standby mode
CONTROL?	LOCAL	Amplifier is in local control mode
	GPIB	Amplifier is in GPIB control mode
	LAN	Amplifier is in LAN control mode
	TTL	Amplifier is in TTL control mode
STATUS?	SYSTEM_OK	Amplifier is working normally
	Interlock External	External Interlock fault
	Temperature X	Over temperature fault at sensor X
	PowerSupply X	Power supply fault at output X
	Control Fault	Internal control fault

**Figure 15: Ethernet interface status messages**

## Remote Control and Interlock Interface

Pin	Signal	Function
1	MAINS ON (100 mA)	Status (CMOS, 12 V = Mains on)
2	OPERATE	Status (CMOS, 12 V = OPERATE)
3	n.u.	Status
4	n.u.	Status
5	TTL REMOTE	Status (CMOS, 12 V = Remote)
6	SUMMARY ALARM	Status (CMOS, 12 V = Fault)
7	GND	
8	EXTERNAL INTERLOCK	
9	OPERATE	Command (negative slope triggered)
10	n.u.	Command (negative slope triggered)
11	TTL REMOTE	Command (negative slope triggered)
12	n.u.	Command (negative slope triggered)
13	n.u.	
14	GND	
15	EXTERNAL INTERLOCK RETURN	

**Figure 16: Signals at the remote control and interlock connector**

All commands and messages, which are available on the front panel, can also be found on the remote control interface. The status messages for all faults are combined to a summary alarm on the interface.

The remote control interface commands are activated by negative slope triggering. (The pulse width should be 10 to 50 ms.) This is done in order not to activate the amplifier immediately on power-on by static remote control interface commands (TTL REMOTE and OPERATE). Triggering on the negative slope permits to control the interface by 12 V CMOS logic or 5 V open-collector TTL logic.

The status output MAINS ON supplies a maximum current of 100 mA at 12 V in order to be able to activate and feed other equipment, or, for example, an external interface and similar devices together with the amplifier.

The amplifier can be set to remote control mode and back to local control mode by using the command TTL REMOTE. At the status display the text will change from LOCAL to TTL. Now the amplifier can be activated using the command OPERATE. The indicated message must then change accordingly from STANDBY to OPERATE.

This page intentionally left blank.

## Appendix A: Warranty

---

### Scope and Duration of Warranties

---

Seller warrants to Buyer that the Products to be delivered hereunder will be (1) free from defects in material, manufacturing workmanship, and title, and (2) conform to the Seller's applicable product descriptions and specifications, if any, contained in or attached to Seller's quotation. If no product descriptions or specifications are contained in or attached to the quotation, Seller's applicable product descriptions and specifications in effect on the date of shipment shall apply. The criteria for all testing shall be Seller's applicable product specifications utilizing factory-specified calibration and test procedures and instruments.

All product warranties, except the warranty of title, and all remedies for warranty failures are limited to three years.

Product Warranted	Duration of Warranty Period
Model 8100-045 RF Power Amplifier	Three Years

Any product or part furnished to Buyer during the warranty period to correct a warranty failure shall be warranted to the extent of the unexpired term of the warranty applicable to the repaired or replaced product.

The warranty period shall commence on the date the product is delivered to Buyer; however, if Seller assembles the product, or provides technical direction of such assembly, the warranty period for such product shall commence on the date the assembly of the product is complete. Notwithstanding the foregoing, in the event that the assembly is delayed for a total of thirty (30) days or more from the date of delivery for any reason or reasons for which Seller is not responsible, the warranty period for such product may, at Seller's options, commence on the thirtieth (30th) day from the date such product is delivered to Buyer. Buyer shall promptly inspect all products upon delivery. No claims for shortages will be allowed unless shortages are reported to Seller in writing within ten (10) days after delivery. No other claims against Seller will be allowed unless asserted in writing within thirty (30) days after delivery (or assembly if the products are to be assembled by Seller) or, in the case of alleged breach of warranty, within the applicable warranty period.

## Warranty Exclusions

---

Except as set forth in any applicable patent indemnity, the foregoing warranties are exclusive and in lieu of all other warranties, whether written, oral, express, implied, or statutory. EXCEPT AS EXPRESSLY STATED ABOVE, SELLER MAKES NO WARRANTY, EXPRESS OR IMPLIED, BY STATUTE OR OTHERWISE, WHETHER OF MERCHANTABILITY OR FITNESS FOR ANY PARTICULAR PURPOSE OR USE OR OTHERWISE ON THE PRODUCTS, OR ON ANY PARTS OR LABOR FURNISHED DURING THE SALE, DELIVERY OR SERVICING OF THE PRODUCTS. THERE ARE NO WARRANTIES WHICH EXTEND BEYOND THE DESCRIPTION ON THE FACE HEREOF.

Warranty coverage does not include any defect or performance deficiency (including failure to conform to product descriptions or specifications) which results, in whole or in part, from (1) negligent storage or handling of the product by Buyer, its employees, agents, or contractors, (2) failure of Buyer to prepare the site or provide an operating environmental condition in compliance with any applicable instructions or recommendations of Seller, (3) absence of any product, component, or accessory recommended by Seller but omitted at Buyer's direction, (4) any design, specification, or instruction furnished by Buyer, its employees, agents or contractors, (5) any alteration of the product by persons other than Seller, (6) combining Seller's product with any product furnished by others, (7) combining incompatible products of Seller, (8) interference with the radio frequency fields due to conditions or causes outside the product as furnished by Seller, (9) improper or extraordinary use of the product, or failure to comply with any applicable instructions or recommendations of Seller including maintenance, calibration and cleaning procedures and intervals, or (10) acts of God, acts of civil or military authority, fires, floods, strikes or other labor disturbances, war, riot, or any other causes beyond the reasonable control of Seller.

This warranty does not include (1) batteries, (2) cables, (3) gasket, (4) fingerstock, or any item that is designed to be consumable. Seller does not warranty products of others which are not included in Seller's published price lists.

## Buyer's Remedies

---

If Seller determines that any product fails to meet any warranty during the applicable warranty period, Seller shall correct any such failure by either, at its option, repairing, adjusting, or replacing without charge to Buyer any defective or nonconforming product, or part or parts of the product. Seller shall have the option to furnish either new or exchange replacement parts or assemblies.

Warranty service shall be performed at the Seller's factory, or the Buyer's site at the sole discretion of the Seller. Within the warranty period, the Buyer shall be responsible for all transportation to the Seller's factory, and the Seller shall be responsible for transportation of goods to the Buyer's site.



Within the contiguous 48 United States, warranty service performed during the applicable warranty period will be performed without charge to Buyer during Seller's normal business hours. After the warranty period, service will be performed at Seller's prevailing service rates. Subject to the availability of personnel, after-hours service is available upon request at an additional charge.

Outside the contiguous 48 United States, travel and per diem expenses, when required, shall be the responsibility of the Buyer, or End User, whichever is applicable regardless of the warranty period.

The remedies set forth herein are conditioned upon Buyer promptly notifying Seller within the applicable warranty period of any defect or non-conformance and making the product available for correction.

The preceding paragraphs set forth Buyer's exclusive remedies and Seller's sole liability for claims based on failure of the products to meet any warranty, whether the claim is in contract, warranty, tort (including negligence and strict liability) or otherwise, and however instituted, and, upon the expiration of the applicable warranty period, all such liability shall terminate. IN NO EVENT SHALL SELLER BE LIABLE TO BUYER FOR ANY SPECIAL, INDIRECT, INCIDENTAL OR CONSEQUENTIAL DAMAGES OF ANY KIND ARISING OUT OF, OR AS A RESULT OF, THE SALE, DELIVERY, NON-DELIVERY, SERVICING, ASSEMBLING, USE OR LOSS OF USE OF THE PRODUCTS OR ANY PART THEREOF, OR FOR ANY CHARGES OR EXPENSES OF ANY NATURE INCURRED WITHOUT SELLER'S WRITTEN CONSENT DESPITE ANY NEGLIGENCE ON BEHALF OF THE SELLER. IN NO EVENT SHALL SELLER'S LIABILITIES UNDER ANY CLAIM MADE BY BUYER EXCEED THE PURCHASE PRICE OF THE PRODUCT IN RESPECT OF WHICH DAMAGES ARE CLAIMED. This agreement shall be construed in accordance with laws of the State of Texas. In the event that any provision hereof shall violate any applicable statute, ordinance, or rule of law, such provision shall be ineffective to the extent of such violation without invalidating any other provision hereof.

Any controversy or claim arising out of or relating to the sale, delivery, non-delivery, servicing, assembling, use or loss of use of the products or any part thereof or for any charges or expenses in connection therewith shall be settled in Austin, Texas by arbitration in accordance with the Rules of the American Arbitration Association, and judgment upon the award rendered by the Arbitrator may be entered in either the Federal District Court for the Western District of Texas or the State District Court in Austin, Texas, all of the parties hereto consenting to personal jurisdiction of the venue of such court and hereby waive the right to demand a jury trial under any of these actions.

This page intentionally left blank.

## **Appendix B: EC Declaration of Conformity**

---

ETS-Lindgren Inc. declares these products to be in conformity with the following standards, following the provisions of EMC Directive 2004/108/EC and Low Voltage Directive 2006/95/EC:

### **RF Power Amplifier Model 8100-045**

- Emission:** EN 61326-1:2006, Class A  
Electrical equipment for measurement, control, and laboratory use.  
**Note: Conducted emission complies with Class B (household equipment).**
- Immunity:** EN 61326-1:2006, Industrial level, performance criteria A  
Electrical equipment for measurement, control, and laboratory use.
- Safety:** EN 61010-1:2010  
Safety requirements for electrical equipment for measurement, control, and laboratory use.

Technical Construction Files are available upon request.

This page intentionally left blank.