

Model 3181 & Model 3184

End Fed Mini-Bicon Antenna

User Manual



Model 3181 / Model 3184

ETS-Lindgren L.P. reserves the right to make changes to any product described herein in order to improve function, design, or for any other reason. Nothing contained herein shall constitute ETS-Lindgren L.P. assuming any liability whatsoever arising out of the application or use of any product or circuit described herein. ETS-Lindgren L.P. does not convey any license under its patent rights or the rights of others.

© Copyright 2019 by ETS-Lindgren L.P. All Rights Reserved. No part of this document may be copied by any means without written permission from ETS-Lindgren L.P.

Trademarks used in this document: The *ETS-Lindgren* logo is a trademark of ETS-Lindgren L.P.

Revision Record

MANUAL,3181 3184 MINI-BICON ANTENNA | Part #399821, Rev. E

Revision	Description	Date
A	Initial Release	October, 2009
B	Updated data charts in <i>Typical Data</i> ; updated <i>Mounting Instructions</i>	November, 2009
C	Updated 3183 illustrations; added note about 3183 stem; updated <i>Physical Specifications</i>	February, 2010
D	Updated 3183 photos; updated 3183 data	March, 2010
E	3183 removed	April, 2019

Table of Contents

Notes, Cautions, and Warnings	vi
1.0 Introduction	8
Model 3181 / Model 3184	8
Tripod Options	9
ETS-Lindgren Product Information Bulletin	9
2.0 Maintenance	11
Annual Calibration	11
Replacement and Optional Parts	11
Service Procedures	12
3.0 Specifications	13
Electrical Specifications	13
Physical Specifications	13
4.0 Mounting Instructions	15
Using the Antenna Mount Assembly on a 4-TR.....	16
Step 1: Attach Antenna Mount Assembly to 4-TR	17
Step 2: Mount Antenna to Antenna Mount Assembly	19
Additional Mounting Options	20
7-TR and Mast Mounting Options	20
2x2 Boom Mounting Options	22
Weatherizing Kit for Outdoor Testing.....	23
Step 1: Wrap Moldable Plastic Seal Tape	24
Step 2: Mold Plastic Seal Tape.....	25
Step 3: Wrap Heavy-Duty All-Weather Vinyl Tape	25
5.0 Typical Data	26
Model 3181	26
3181 Antenna Factor / Gain.....	26
3181 VSWR	27
Model 3184	28
3184 Antenna Factor / Gain.....	28
3184 VSWR	29
Typical E-Plane Patterns—Model 3181	30
3181 E-Plane at 500 MHz—1 GHz.....	30

3181 E-Plane at 2 GHz –5 GHz.....	31
3181 E-Plane at 6 GHz–9 GHz.....	32
3181 E-Plane at 10 GHz–13 GHz.....	33
3181 E-Plane at 14 GHz–18 GHz.....	34
Typical E-Plane Patterns—Model 3184.....	35
3184 E-Plane at 2 GHz–3 GHz.....	35
3184 E-Plane at 4 GHz–5 GHz.....	36
3184 E-Plane at 6 GHz–7 GHz.....	37
3184 E-Plane at 8 GHz–9 GHz.....	38
3184 E-Plane at 10 GHz–11 GHz.....	39
3184 E-Plane at 12 GHz–13 GHz.....	40
3184 E-Plane at 14 GHz–15 GHz.....	41
3184 E-Plane at 16 GHz–17 GHz.....	42
3184 E-Plane at 18 GHz.....	43
Typical H-Plane Patterns—Model 3184.....	44
3184 H-Plane at 1 GHz.....	44
3184 H-Plane at 2 GHz–18 GHz	45
Appendix A: Warranty	46

This page intentionally left blank.

Notes, Cautions, and Warnings

	<p>Note: Denotes helpful information intended to provide tips for better use of the product.</p>
<p>CAUTION</p>	<p>Caution: Denotes a hazard. Failure to follow instructions could result in minor personal injury and/or property damage. Included text gives proper procedures.</p>
<p>WARNING</p>	<p>Warning: Denotes a hazard. Failure to follow instructions could result in SEVERE personal injury and/or property damage. Included text gives proper procedures.</p>



See the ETS-Lindgren *Product Information Bulletin* for safety, regulatory, and other product marking information.

This page intentionally left blank.

1.0 Introduction

The **ETS-Lindgren End Fed Mini-Bicons** includes these two groups of broadband omni-directional antennas:

Model 3181 / Model 3184

The Model 3181/3184 is designed for surveillance, spectrum monitoring, and shielding tests.

The frequency range for the Model 3181 is 500 MHz to 9 GHz and the frequency range for the Model 3184 is 1 GHz to 18 GHz.

The Model 3181 performs best up to 9 GHz, but is usable to 18 GHz if amplification is used. The Model 3184 performs better than the Model 3181 in the 9 GHz to 18 GHz range. Data to 18 GHz is provided for both antennas.

The radome provides weather protection for outdoor testing, and a weatherizing kit is included to protect the antenna connection.



The radiation pattern is omni-directional in the H-plane, allowing the antenna to receive signals from every direction around the axis. The range covers most wireless bands worldwide, and is designed for the lowest possible VSWR across the range of operation. The antenna exhibits better than 2:1 VSWR for most of the range, and never exceeds 5:1 above 1 GHz.

The small sizes of the antennas enable them to be used for amplifier harmonic measurements when performing tests per IEC 61000-4-3.

Each antenna is calibrated during manufacturing. The results of the calibration are tabulated as gain and antenna factor vs. frequency for use in Specification Compliance Testing. Typical data is provided starting on page 26.

The Model 3181/3184 includes a stinger mount and ships with an antenna mount assembly for a variety of mounting configurations. For information on the 4-TR, see the next section, *Tripod Options*; for mounting information, see *Mounting Instructions* on page 15.

Tripod Options

ETS-Lindgren offers the 4-TR non-metallic, non-reflective tripod for use at both indoor and outdoor EMC test sites.

- Constructed of linen phenolic and delrin, designed with an adjustable center post for precise height adjustments.
- Maximum height is 2.0 m (80.0 in), and minimum height is 94 cm (37.0 in).
- Can support up to an 11.8 kg (26.0 lb) load.



ETS-Lindgren Product Information Bulletin

See the ETS-Lindgren *Product Information Bulletin* included with your shipment for the following:

- Warranty information
- Safety, regulatory, and other product marking information
- Steps to receive your shipment
- Steps to return a component for service
- ETS-Lindgren calibration service
- ETS-Lindgren contact information

This page intentionally left blank.

2.0 Maintenance

CAUTION

Before performing any maintenance, follow the safety information in the ETS-Lindgren *Product Information Bulletin* included with your shipment.



Maintenance of the Model 3181/3184 is limited to external components such as cables or connectors.

If you have any questions concerning maintenance, contact ETS-Lindgren Customer Service.

Annual Calibration

See the *Product Information Bulletin* included with your shipment for information on ETS-Lindgren calibration services.

Replacement and Optional Parts

Following are the part numbers for ordering replacement or optional parts for the Model 3181/3184 End Fed Mini–Bicon Antennas.

Part Description	Part Number
Assembly, Antenna Mount	113956



The 114669 Spacer is included in the 113956 Antenna Mount Assembly, but may also be ordered separately.

Spacer, Extension, Antenna Mount	114669
Moldable Plastic Seal Tape	920381
Heavy-duty All-weather Vinyl Tape	920382

Service Procedures

For the steps to return a system or system component to ETS-Lindgren for service, see the *Product Information Bulletin* included with your shipment.

3.0 Specifications

Electrical Specifications

Frequency Range:	<ul style="list-style-type: none">• 3181: 500 MHz–9 GHz• 3184: 1 GHz–18 GHz
VSWR Ratio (Average):	2:1
Maximum Continuous Power:	100 W @ 500 MHz 50 W @ 1 GHz 25 W @ 18 GHz
Impedance:	50 Ω
Connector:	SMA female

Physical Specifications

Length:	<ul style="list-style-type: none">• 3181/3184: 38.35 cm (15.1 in)
Width:	<ul style="list-style-type: none">• 3181/3184: 15.25 cm (6.0 in)
Stinger Length:	<ul style="list-style-type: none">• 3181/3184: 16.0 cm (6.32 in)
Weight:	<ul style="list-style-type: none">• 3181: 1.03 kg (2.28 lb)• 3184: 0.65 kg (1.43 lb)

This page intentionally left blank.

4.0 Mounting Instructions

CAUTION

Before connecting any components, follow the safety information in the ETS-Lindgren *Product Information Bulletin* included with your shipment.

CAUTION

The Model 3181/3184 antennas are precision measurement devices. Handle your antenna with care.

Using the Antenna Mount Assembly on a 4-TR



The antenna mount assembly ships with this larger knob in place of the thumbscrew shown in the following photos. The larger knob provides the same functionality but provides increased usability.

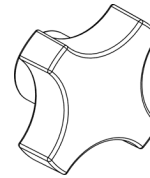

Each Model 3181/3184 End Fed Mini-Bicon Antenna ships with an antenna mount assembly for a variety of mounting configurations. To use the antenna mount assembly with an ETS-Lindgren 4-TR Tripod, select the antenna mounting orientation, attach the antenna mount assembly to the 4-TR, and then attach the antenna to the antenna mount assembly. Each step is detailed in the following sections.

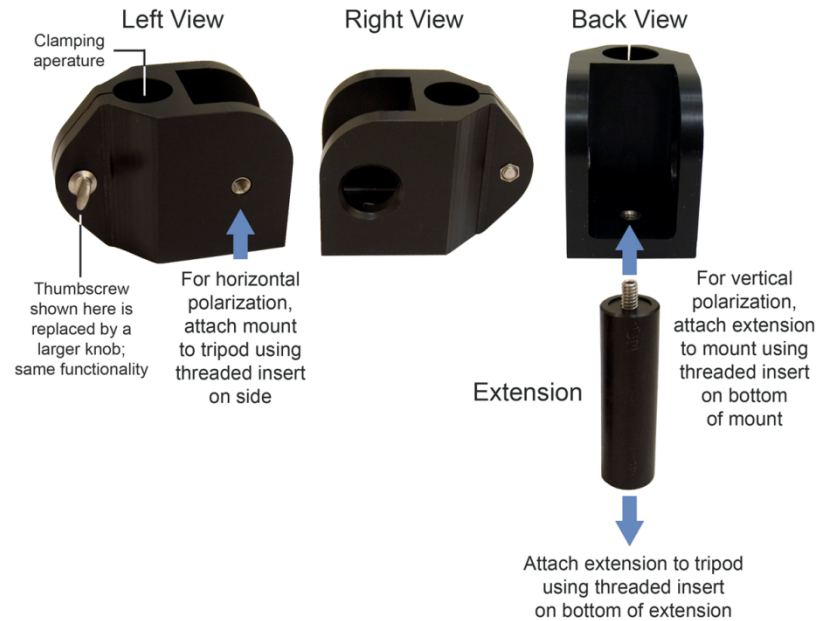

STEP 1: ATTACH ANTENNA MOUNT ASSEMBLY TO 4-TR

You may use the antenna mount assembly to mount the Model 3181/3183/3184 in vertical or horizontal orientation.

- **Vertical orientation:**

Attach the extension to the threaded insert on the bottom of the mount and rotate to tighten into place.

Attach the extension to the 4-TR using the threaded insert on the bottom of the extension. Turn the extension to secure the antenna mount assembly to the 4-TR.



- **Horizontal orientation:** You may attach the antenna mount assembly directly to the 4-TR, or you may use the extension to attach it to the 4-TR.



To direct mount, attach the mount to the 4-TR using the threaded insert on the side of the mount. Rotate to tighten into place.

To use the extension, attach the extension to the mount using the threaded insert on the side of the mount, and then turn the extension to tighten. Attach the extension to the 4-TR using the threaded insert on the bottom of the extension. Rotate to tighten into place.

STEP 2: MOUNT ANTENNA TO ANTENNA MOUNT ASSEMBLY

- Turn the thumbscrew/knob to loosen it.
- Insert the antenna stinger into and through the clamping aperture.
- Turn the thumbscrew/knob to tighten it and secure the antenna in place.



Vertical Mount



Horizontal Mount

Additional Mounting Options

7-TR AND MAST MOUNTING OPTIONS



To mount the Model 3181/3184 vertically to a 7-TR or mast using the antenna mount assembly, you must place the 114669 spacer over the extension.

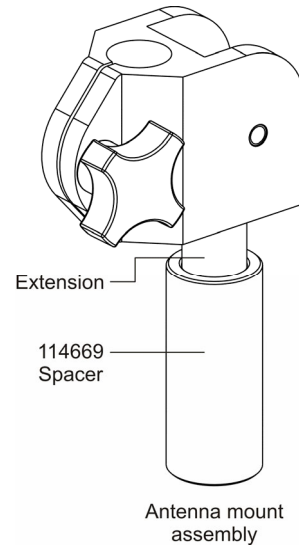

Following are options for mounting the Model 3181/3184 onto an ETS-Lindgren 7-TR Tripod or mast. See *Using the Antenna Mount Assembly on a 4-TR* on page 16 for additional mounting and assembly information.

Contact the ETS-Lindgren Sales Department for information on ordering optional mounting hardware.



Mast refers to 2070 Series, 2075, and 2175 Antenna Towers. 7-TR refers to 109042, 106328, and 108197 booms:

- 109042 boom—Straight boom; for general antenna mounting on a 7-TR
- 106328 boom—Offset boom; for general antenna mounting on a 7-TR with pneumatic or manual polarization
- 108197 boom—Center rotate boom; for rear-mount stinger-type antennas only

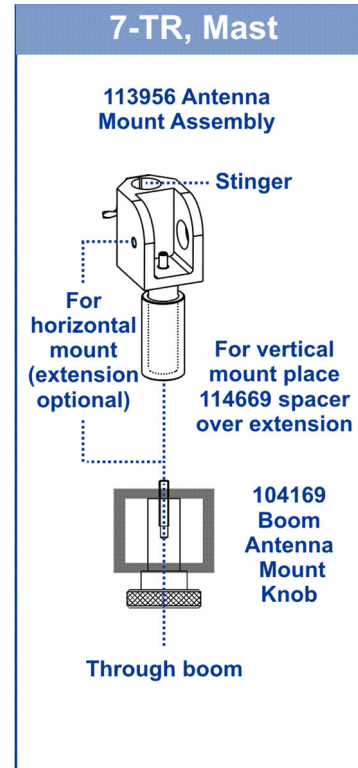

2x2 BOOM MOUNTING OPTIONS

Following are additional options for mounting the Model 3181/3184 onto a 2x2 boom. See *Using the Antenna Mount Assembly on a 4-TR* on page 16 for additional mounting and assembly information.

Contact the ETS-Lindgren Sales Department for information on ordering optional mounting hardware.



2x2 boom refers to a typical 2-inch by 2-inch boom.

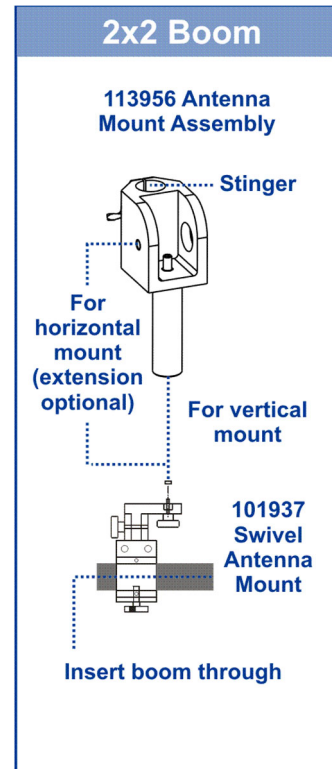

Weatherizing Kit for Outdoor Testing



The antenna mount assembly ships with this larger knob in place of the thumbscrew shown in the following photos. The larger knob provides the same functionality but provides increased usability.

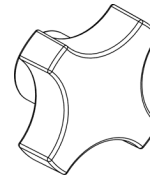

The Model 3181/3184 ships with a weatherizing kit to protect the cable connection during outdoor use. The kit includes moldable plastic seal tape and heavy-duty all-weather vinyl tape.

Moldable plastic seal tape (inner layer)



Heavy-duty all-weather vinyl tape (outer layer)



Plastic seal tape and vinyl tape applied



To order additional tape, see *Replacement and Optional Parts* on page 11 for part number information.

Follow these steps to apply the tapes:

STEP 1: WRAP MOLDABLE PLASTIC SEAL TAPE

- Make sure the antenna shaft, cable, and connectors are clean and dry.
- Attach the antenna cable to the antenna connector.
- Start wrapping the plastic seal tape 1.0 inch below the base of the antenna cable connector cover, and wrap upward to 1.0 inch above the base of the antenna shaft.
- As you wrap, overlap the previous wrap layer by 1/2 the width of the tape.



STEP 2: MOLD PLASTIC SEAL TAPE

- Press firmly and uniformly over the plastic seal tape to mold it into place.
- Squeeze out any trapped air as you press the plastic seal tape.

Press firmly and uniformly over plastic seal tape



STEP 3: WRAP HEAVY-DUTY ALL-WEATHER VINYL TAPE

- Start wrapping 1/2 inch below where the plastic seal tape begins and wrap upward to 1/2 inch above where the seal tape stops.
- As you wrap, stretch the vinyl tape slightly to avoid creases and bubbles.
- When done, inspect the tape to make sure everything is covered and sealed.

Wrap vinyl tape up from bottom



5.0 Typical Data

Model 3181

3181 ANTENNA FACTOR / GAIN

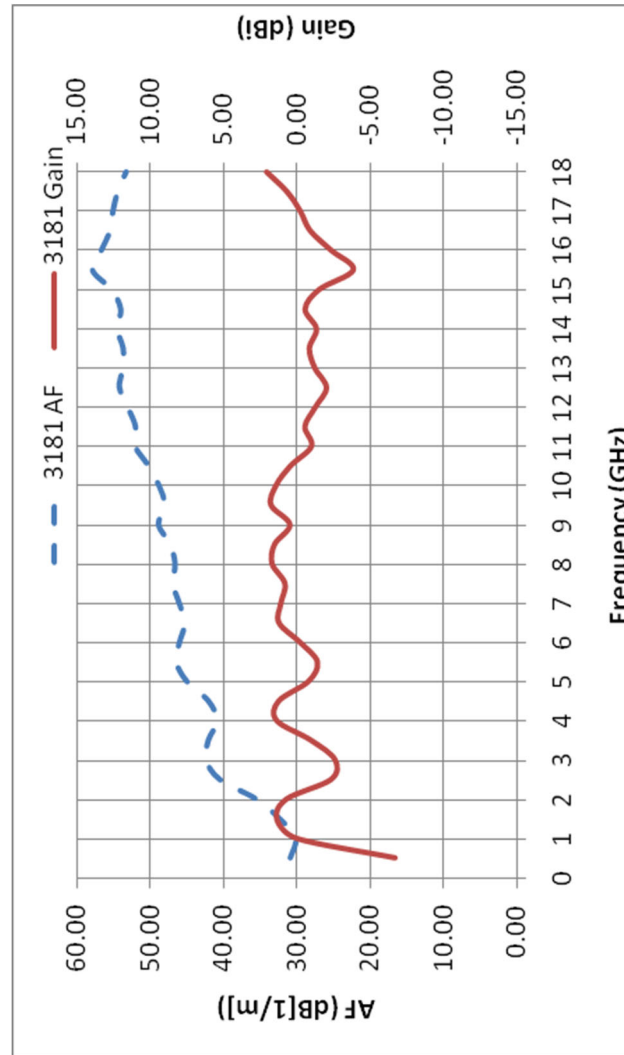

3181 VSWR

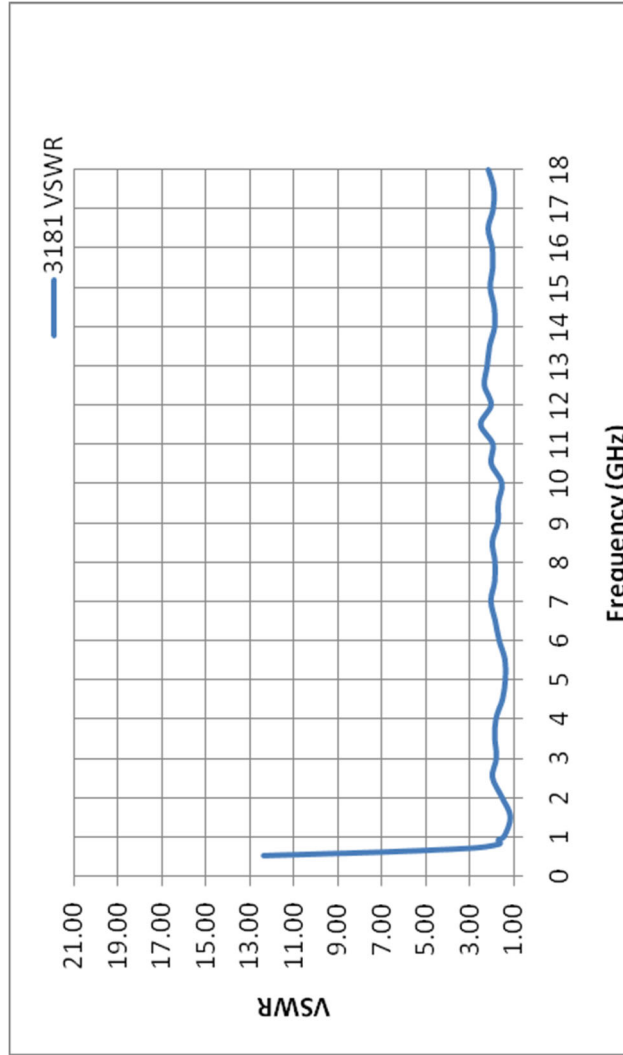

Model 3184

3184 ANTENNA FACTOR / GAIN

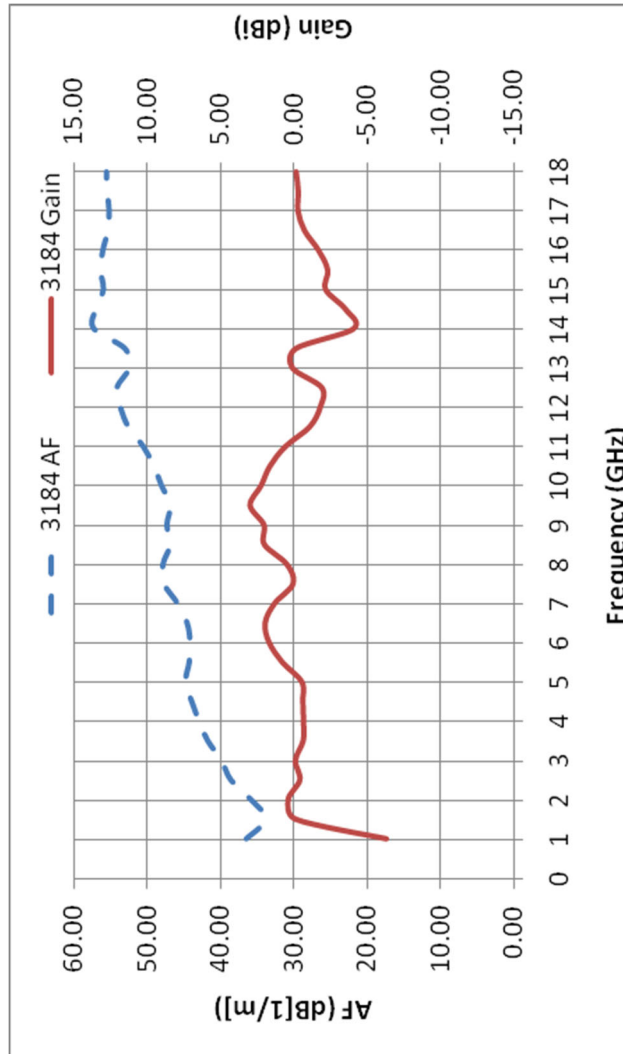

3184 VSWR

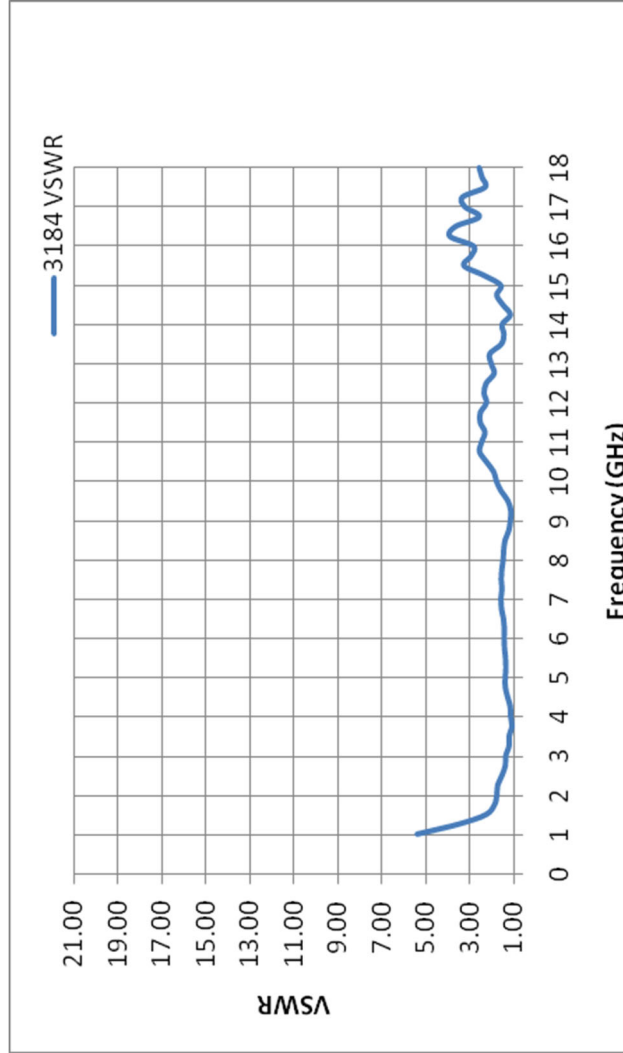

Typical E-Plane Patterns—Model 3181

3181 E-PLANE AT 500 MHz—1 GHz

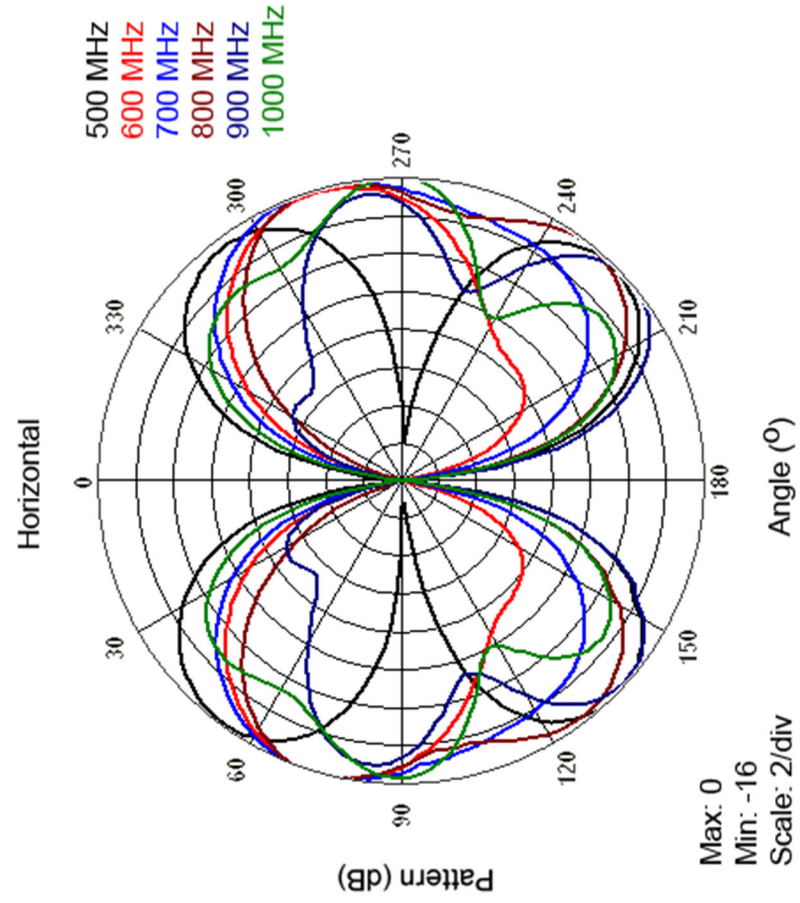

3181 E-PLANE AT 2 GHz –5 GHz

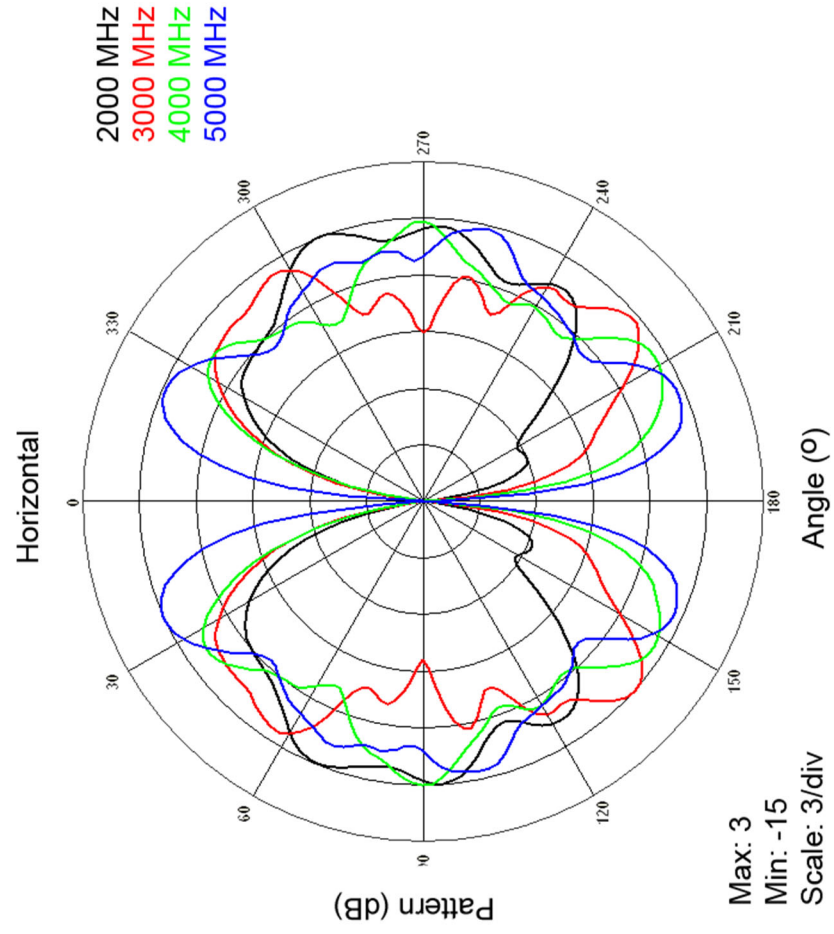

3181 E-PLANE AT 6 GHZ-9 GHZ

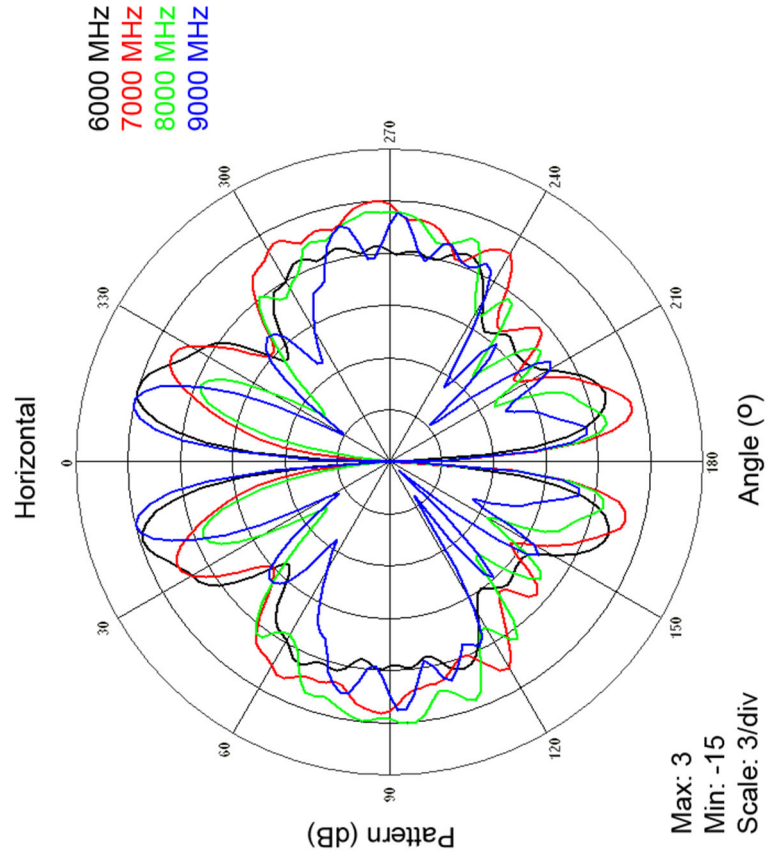

3181 E-PLANE AT 10 GHz–13 GHz

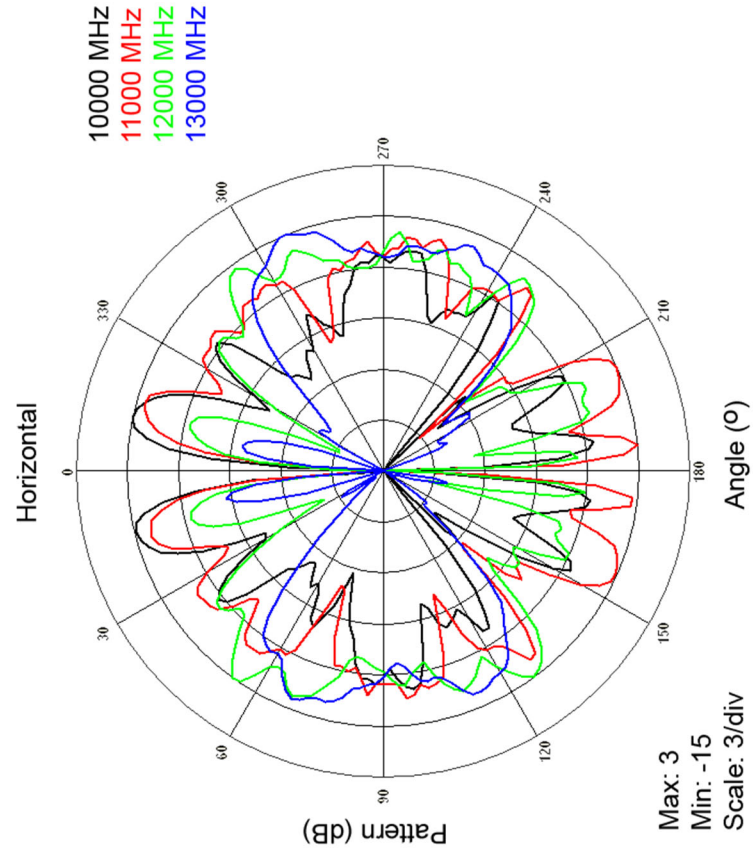

3181 E-PLANE AT 14 GHZ-18 GHZ

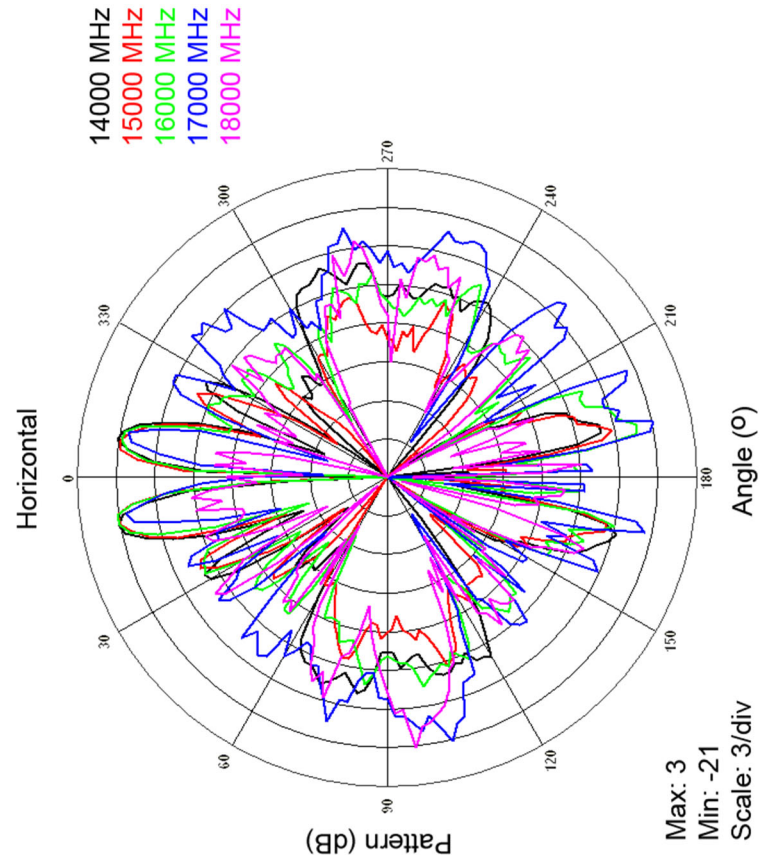

Typical E-Plane Patterns—Model 3184

3184 E-PLANE AT 2 GHz–3 GHz

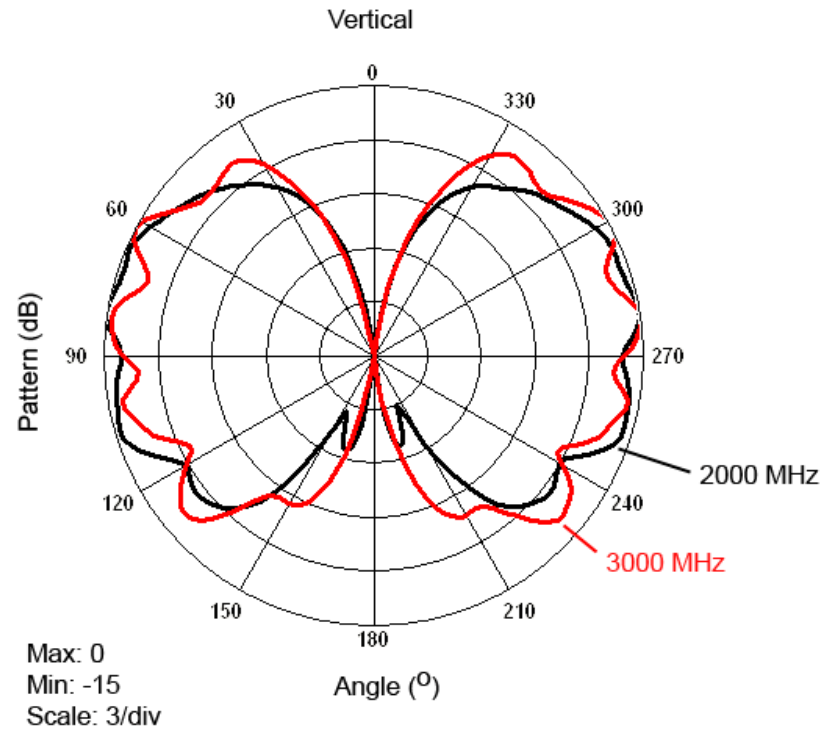

3184 E-PLANE AT 4 GHz–5 GHz

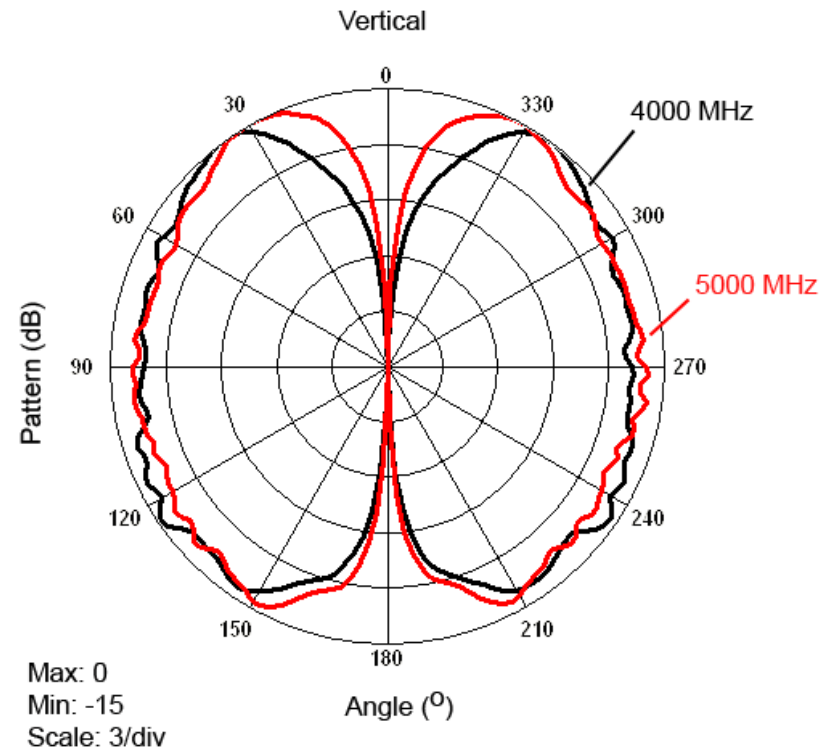

3184 E-PLANE AT 6 GHz–7 GHz

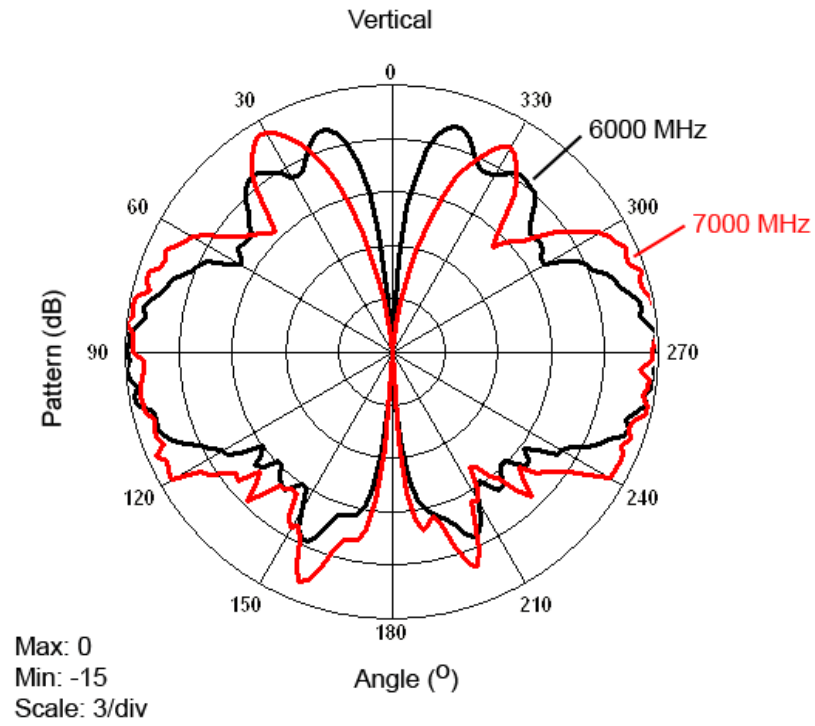

3184 E-PLANE AT 8 GHz–9 GHz

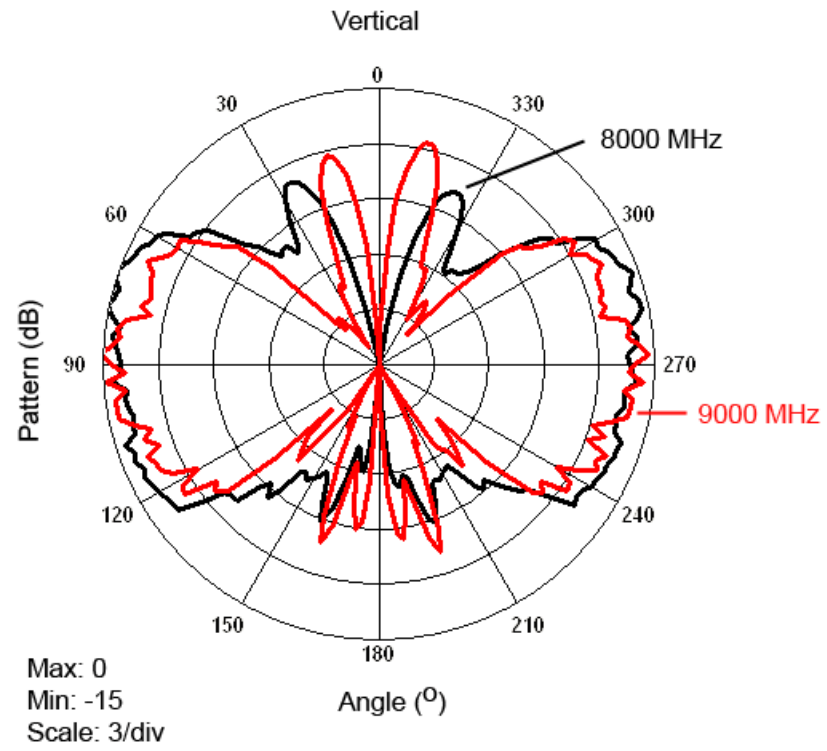

3184 E-PLANE AT 10 GHz–11 GHz

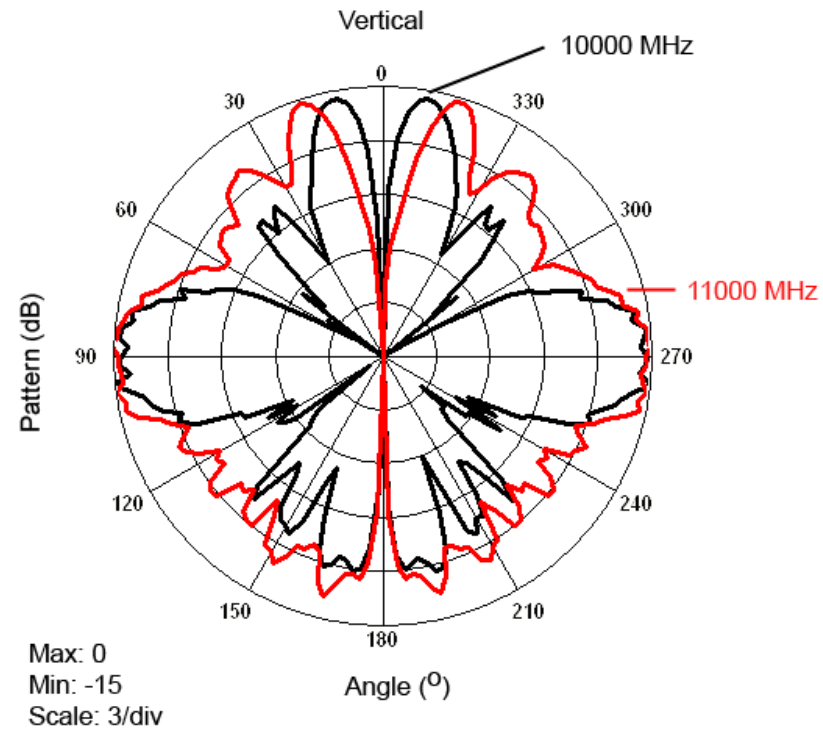

3184 E-PLANE AT 12 GHz–13 GHz

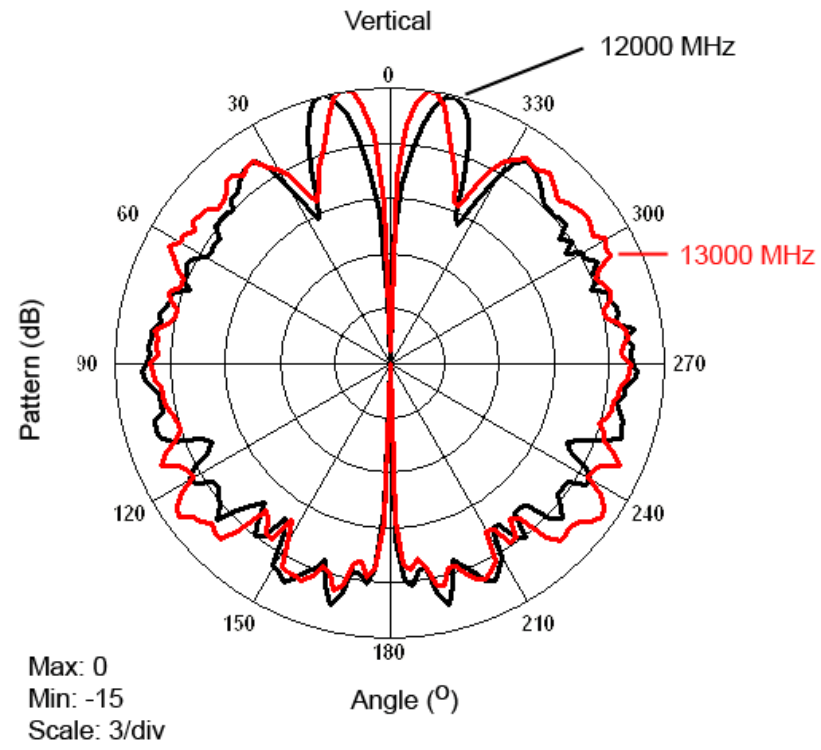

3184 E-PLANE AT 14 GHz–15 GHz

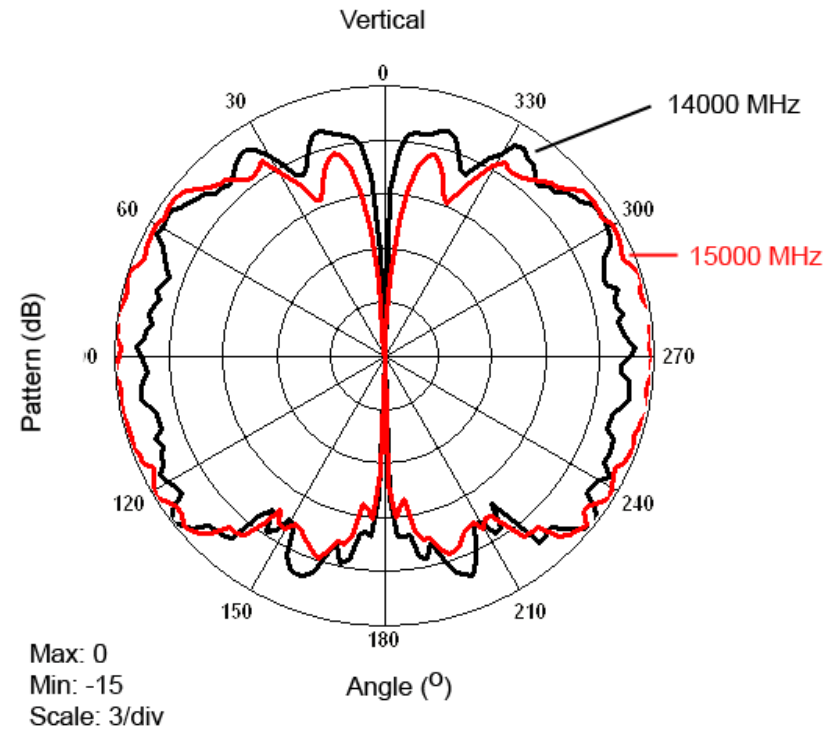

3184 E-PLANE AT 16 GHz–17 GHz

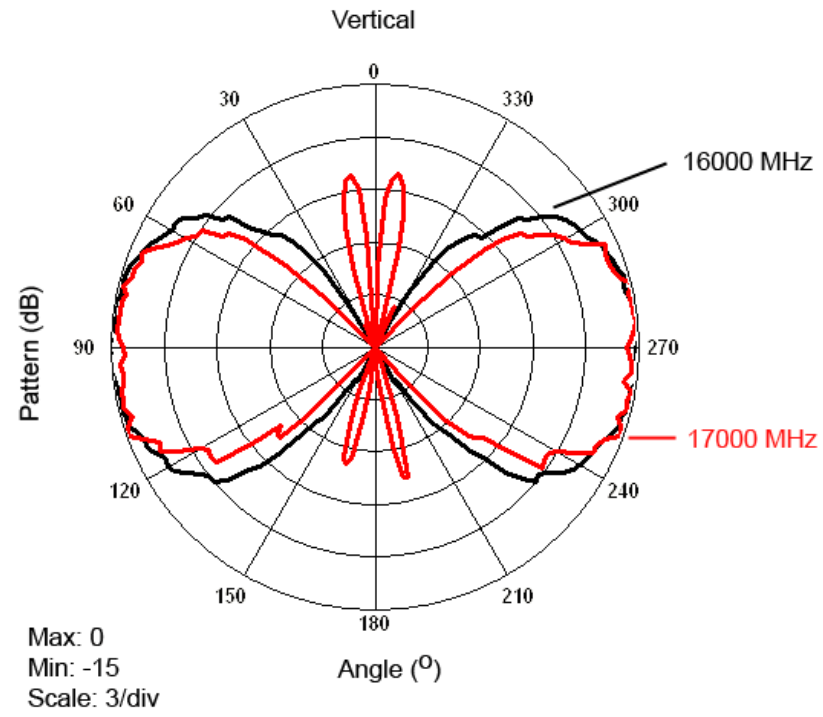

3184 E-PLANE AT 18 GHZ

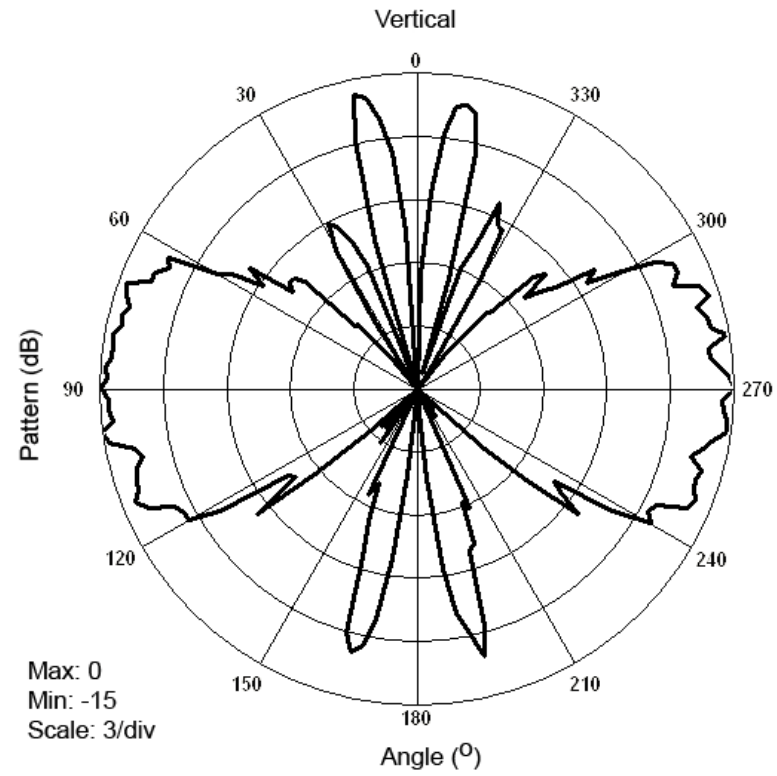

Typical H-Plane Patterns—Model 3184

3184 H-PLANE AT 1 GHz

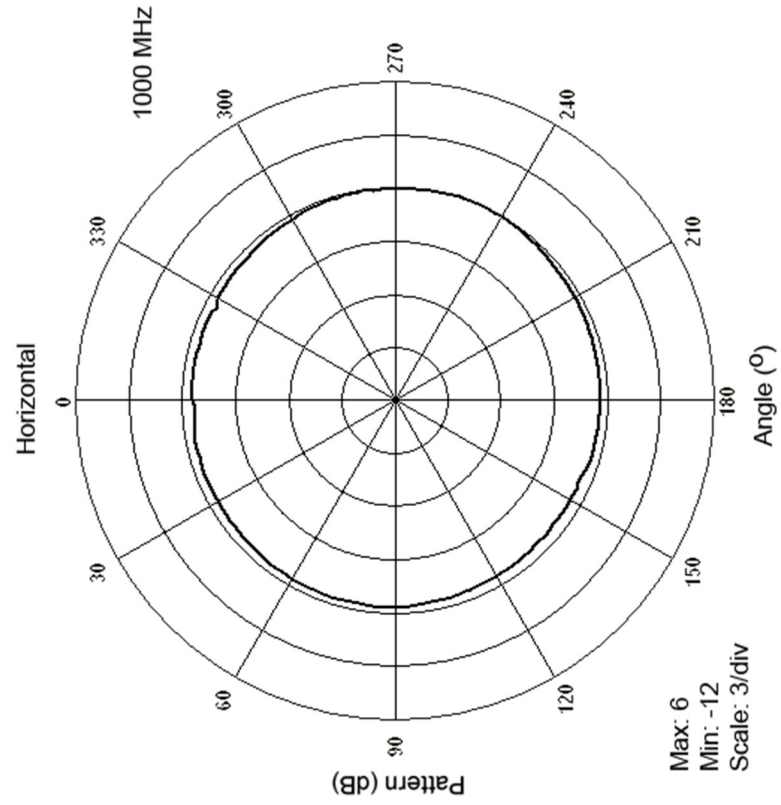

3184 H-PLANE AT 2 GHz–18 GHz

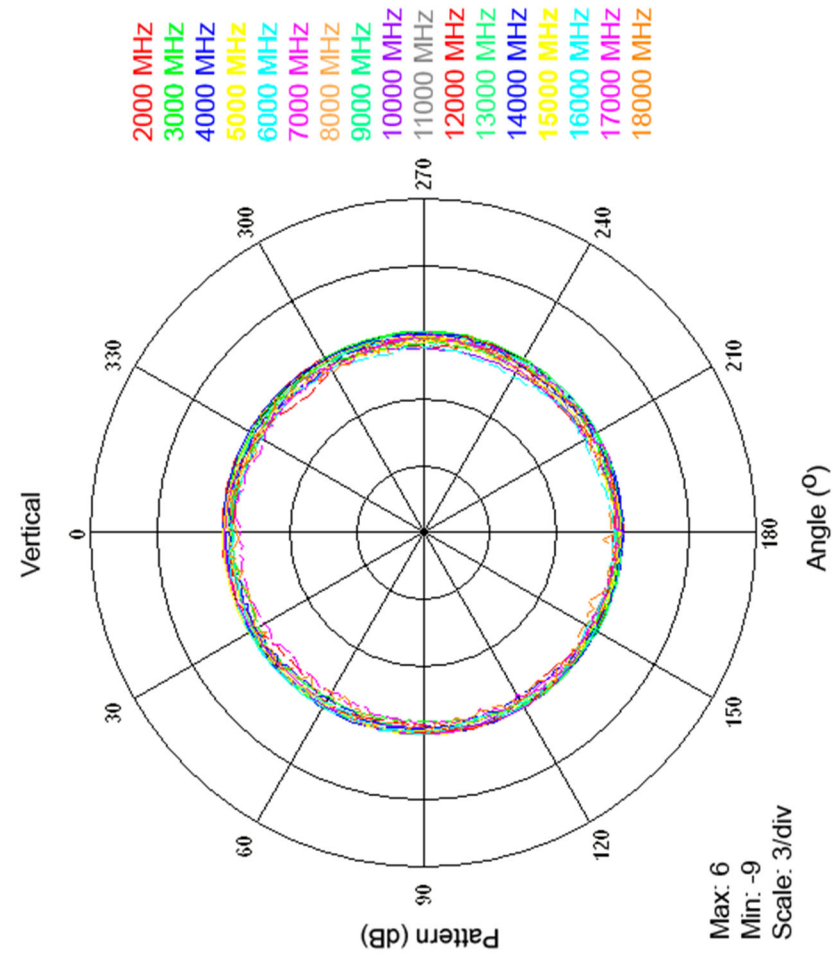

Appendix A: Warranty



See the *Product Information Bulletin* included with your shipment for the complete ETS-Lindgren warranty for your Model 3181/3184.

DURATION OF WARRANTIES FOR MODEL 3181/3184

All product warranties, except the warranty of title, and all remedies for warranty failures are limited to two years.

Product Warranted	Duration of Warranty Period
Model 3181 End Fed Mini-Bicon Antenna	2 Years
Model 3184 End Fed Mini-Bicon Antenna	2 Years