

Model 3301C

Active Monopole Antenna

User Manual



Model 3301C Antenna Base



ETS-Lindgren Inc. reserves the right to make changes to any products herein to improve functioning or design. Although the information in this document has been carefully reviewed and is believed to be reliable, ETS-Lindgren does not assume any liability arising out of the application or use of any product or circuit described herein; nor does it convey any license under its patent rights nor the rights of others. All trademarks are the property of their respective owners.

© Copyright 2009–2021 by ETS-Lindgren L.P. All Rights Reserved. No part of this document may be copied by any means without written permission from ETS-Lindgren Inc.

Trademarks used in this document: The *ETS-Lindgren* logo is a trademark of ETS-Lindgren Inc.

Revision Record

MANUAL,3301C ACTIVE ROD ANTENNA,USER | Part #399792, Rev. K

Revision	Description	Date
A	Initial Release	October, 2009
B	Updated part numbers in <i>Replacement and Optional Parts</i>	December, 2009
C	Updated monopole rod element information	July, 2011
D	Added battery shelf life and storage information	November, 2016
E	Added calibration fixture information	September, 2018
F	Added statement that batteries should be replaced every 2 years	November, 2018
G	Corrected information on MIL-STD-461 Kit	June, 2020
H	Fixed typo	July, 2020
J	Added CISPR Adapter information	December, 2020
K	Corrected dip switch setting	April, 2021

Table of Contents

Notes, Cautions, and Warnings	v
General Notices	v
1.0 Introduction	7
Standard Configuration.....	8
Antenna Base	8
Monopole Element.....	9
Counterpoise	10
Rechargeable AA Nickel-Metal Hydride batteries (8).....	10
MIL-STD-461F/G	10
Test Kit.....	10
4-TR Light Tripod (Sold Separately).....	11
ETS-Lindgren Product Information Bulletin	12
2.0 Maintenance	13
Battery Replacement	13
Annual Calibration	16
Replacement and Optional Parts.....	16
Replacement Parts	16
Optional Parts (each sold separately).....	17
Service Procedures	17
3.0 Specifications	19
Operational Specifications	19
Table of Acceptable Pulse Repetition Rates	20
Electrical Specifications	21
Physical Specifications	21
AC Adapter & Battery Specifications	22
4.0 Assembly Instructions	23
Counterpoise and Monopole Element	23
MIL-STD-461F/G Test Kit.....	28
5.0 Mounting Instructions	31
4-TR Light Tripod Mounting Options (Sold Separately).....	31
7-TR and Mast Mounting Options (Sold Separately).....	32

2x2 Boom Mounting Options (Sold Separately).....	33
6.0 Operation	35
Front Panel Controls and Indicators	35
Charge Status LED.....	35
Charger Connector	36
Saturation LED	36
Output Connector	37
Power LED.....	37
Power Switch	37
DIP Switches	38
For Internal Attenuation / Low Frequency Roll Off	38
Alarm DIP Switches	40
Change DIP Switch Settings.....	41
Charging the Batteries	42
7.0 Calibrating the Model 3301C.....	43
Calibration Steps	43
Model 3301 Calibration With Receiver and Signal Generator	46
Model 3301 Calibration With Network Analyzer	47
Example of Antenna Factors Calculation with 1 meter Monopole	48
8.0 Data and Illustrations	49
Periodic Rectangular Pulse Train	49
Spectrum of Rectangular Pulse	50
Altering Pulse Width / Pulse Repetition Rate.....	51
Active Electric Field Antenna Calibration Fixture.....	52
Active Monopole Antenna Calibration Setup	53
Typical Curves–Typical Antenna Factors at the Default Switch Position (All Off).....	54
Typical Curves–Typical Maximum Noise Voltage Using 10 Hz Bandwidth	55
Typical Curves–Typical Minimum Discernable Electric Field Levels (dB μ V/m) Under Different Bandwidths.....	56
Typical Antenna Factors for Different Switch Configurations	57
Appendix: EC Declaration of Conformity	59

Notes, Cautions, and Warnings

	Note: Denotes helpful information intended to provide tips for better use of the product.
CAUTION	Caution: Denotes a hazard. Failure to follow instructions could result in minor personal injury and/or property damage. Included text gives proper procedures.
WARNING	Warning: Denotes a hazard. Failure to follow instructions could result in SEVERE personal injury and/or property damage. Included text gives proper procedures.



See the ETS-Lindgren *Product Information Bulletin* for safety, regulatory, and other product marking information.

General Notices

FCC Certifications	This equipment has been tested and found to comply with the limits for a Class A digital device, pursuant to part 5 of the FCC Rules.
---------------------------	---



See the ETS-Lindgren *Product Information Bulletin* for safety, regulatory, and other product marking information.

This page intentionally left blank.

1.0 Introduction

The **ETS-Lindgren Model 3301C Active Monopole Antenna** is a broadband, high sensitivity electric-field receiving antenna. The Model 3301C is composed of:

- Monopole element
- Counterpoise
- Broadband, high input impedance preamplifier

The monopole and counterpoise function together as an electrically short antenna over ground plane. The preamplifier provides impedance transformation from the high impedance at the base of the monopole to the 50 ohms required by most receiving systems, and provides power gain to allow the sensing of low-level signals.

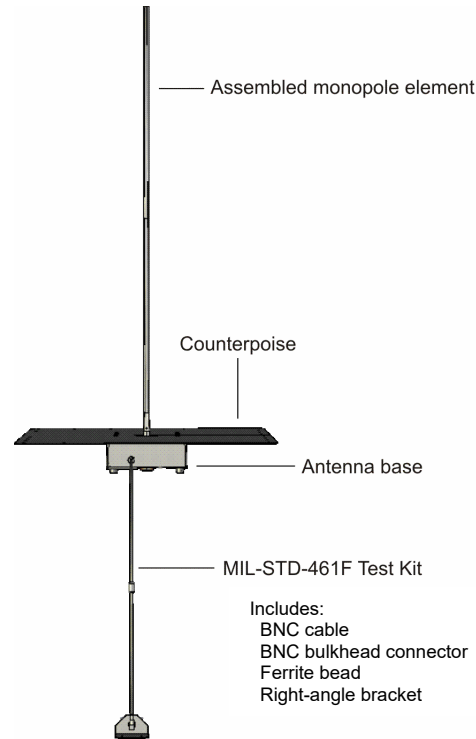

The Model 3301C is designed to provide reception of an electric field in a signal band without tuning or band switching from 30 Hz to 50 MHz. The 3 dB roll off points for the antenna factor are at 170 Hz and 30 MHz. Between 250 Hz and 20 MHz, the antenna factor is flat within +/- 1 dB. Despite the roll of the antenna factor, the usable range is 30 Hz to 50 MHz.

The Model 3301C is designed for maximum sensitivity and dynamic range, and is capable of sensing fields of 7 dBuV/m at 1 MHz with a 1 kHz bandwidth. However, it will not saturate below field strength of 0.8 V/m. As a result, the unit provides a wide dynamic range of 111 dB nominal at mid-band. In addition, at 10 dB and 30 dB (+/-10%), internal attenuators enable the Model 3301C to be used in fields up to 25 V/m, expanding the dynamic range to 141 dB. A saturation indicator provides an alert to the need for internal attenuators.

Standard Configuration

ANTENNA BASE

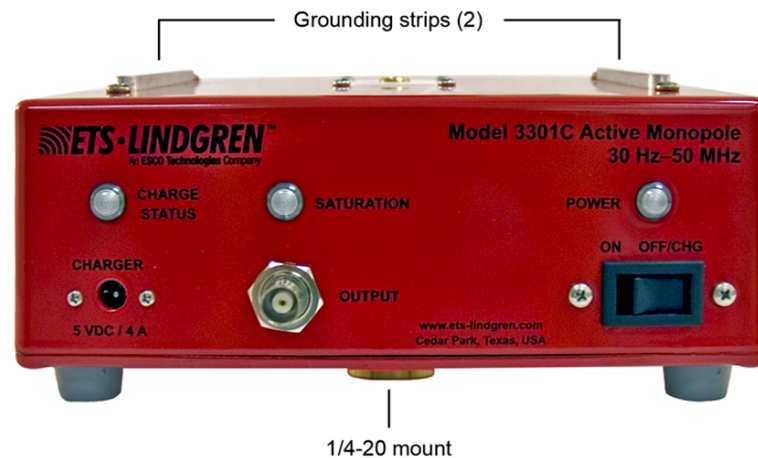

- Includes built-in preamplifier and BNC (output) connector. Base is drilled to accept ETS-Lindgren or other tripod mount with standard 1/4-20 threads.
- Four thumbscrew knobs used to secure the counterpoise to the metal grounding strips on the top of the antenna base are shipped attached to the grounding strips (thumbscrews not shown in photo).

For a complete description of the Model 3301C controls, switches, and indicator lights, see *Operation* on page 35.

MONOPOLE ELEMENT

The monopole element includes these parts for assembly:

- (1) 116474 Rod section without antenna adapter
- (1) 116474 Rod section with antenna adapter
- (1) 116862 Center section

The monopole may be assembled as follows:

- **For a finished length of 40.95 in (1040 mm)**—Assemble all parts, including the 116862 center section.
- **For a finished length of 39.37 in (1000 mm)**—Assemble all parts except for the 116862 center section.

See page 26 for the steps to assemble the monopole.

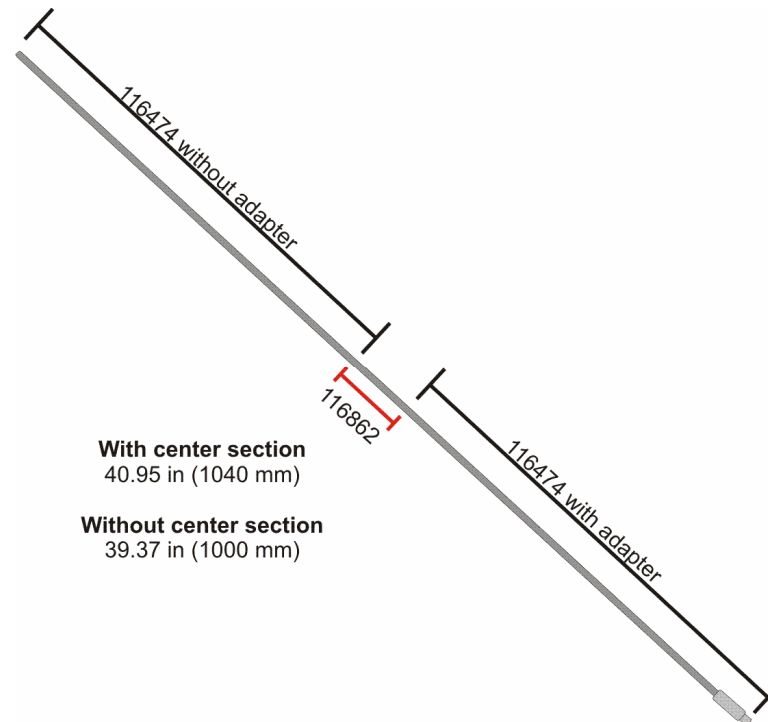

COUNTERPOISE

The two halves assemble into a 24 in by 24 in square (60.96-cm square).

To extend the ground plane, the counterpoise may be attached to a workbench using the holes around the perimeter of the counterpoise.

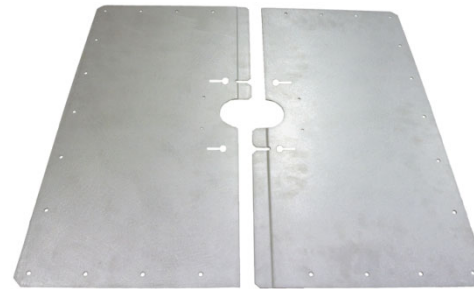

Holes around the perimeter of the counterpoise to extend the ground plane

RECHARGEABLE AA NICKEL-METAL HYDRIDE BATTERIES (8)

The Model 3301C is shipped with 8 Nickel-Metal Hydride (NiMH) batteries installed. The batteries are rechargeable, and include an AC adapter for charging. You must charge the batteries before using the Model 3301C for the first time. See *Charging the Batteries* on page 42 for more information.

MIL-STD-461F/G TEST KIT

To comply with the standard, the MIL-STD-461F/G Test Kit includes a 27-in BNC cable, BNC bulkhead connector, ferrite bead, and a right-angle bracket.

For information on using the kit, see page 28.

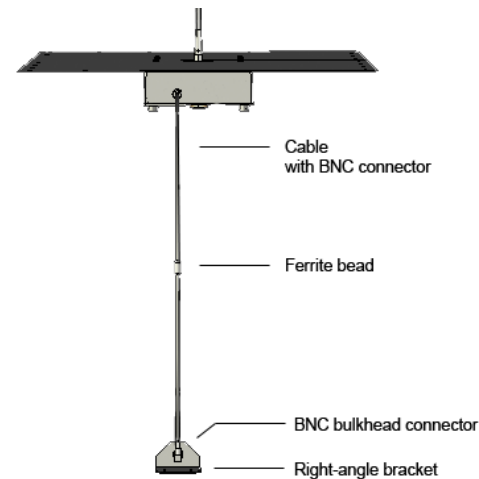

4-TR Light Tripod (Sold Separately)

ETS-Lindgren offers the non-metallic, non-reflective **4-TR Light Tripod** for use at both indoor and outdoor EMC test sites.

- Constructed of linen phenolic and delrin, designed with an adjustable center post for precise height adjustments.

Maximum height is 1.00 m (39.37 in), and minimum height is 0.50 m (19.68 in). This tripod can support up to a 2.27 kg (5.0 lb) load.



*Model 3301C shown mounted
with MIL-STD-461F/G Test Kit
onto 4-TR Light Tripod*

ETS-Lindgren Product Information Bulletin

See the ETS-Lindgren *Product Information Bulletin* included with your shipment for the following:

- Safety, regulatory, and other product marking information
- Steps to receive your shipment
- Steps to return a component for service
- ETS-Lindgren calibration service
- ETS-Lindgren contact information

2.0 Maintenance

CAUTION

Before performing any maintenance, follow the safety information in the ETS-Lindgren *Product Information Bulletin* included with your shipment.



Maintenance of the Model 3301C is limited external components such as cables or connectors.

Clean the exterior of the cabinet using a damp cloth and mild cleaner. Always unplug the unit before cleaning.

If you have any questions concerning maintenance, contact ETS-Lindgren Customer Service.

Battery Replacement



At end of useful life, please recycle the used batteries, or dispose of them safely and properly. Many cities collect used batteries for recycling or disposal. You may contact your local waste disposal agency for information on battery recycling and disposal.



If the unit may be idle (shelved and unused) for more than a month, remove the batteries and store them separately. Check them before reinstalling them in the unit and install fresh batteries if necessary.



ETS-Lindgren recommends replacing the battery every two years.

1. Place the power switch in the OFF/CHG position. See *Operation* on page 35 for information on the front panel controls and indicators.
2. Remove the monopole element and counterpoise. See *Counterpoise and Monopole Element* on page 23 for more information.

3. Disconnect all cables from the antenna base.
4. Turn over the Model 3301C antenna base and place it on a stable surface with the bottom facing up.

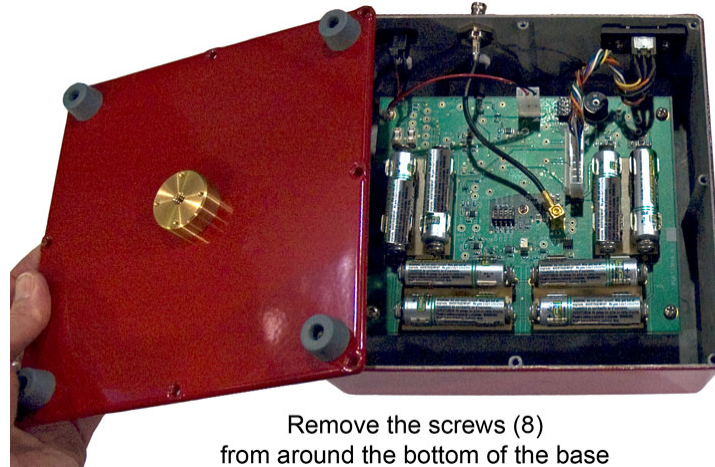

5. Use a Phillips screwdriver to remove the eight screws from around the perimeter of the base, and then lift the lid to remove it from the base.
6. Lift and remove each battery from the battery holder.

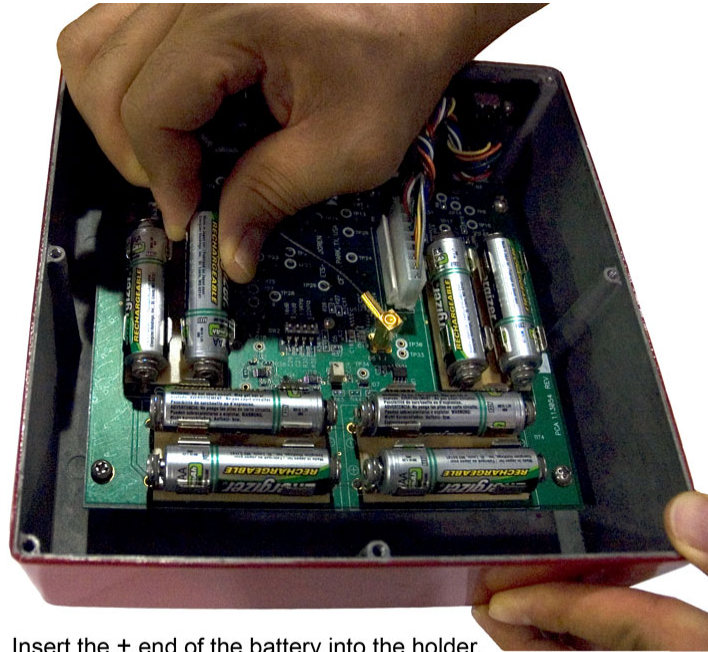

Insert the + end of the battery into the holder,
and then insert the - end of the battery

7. Insert one new battery into each battery holder, matching the **-/+** on the battery with the **-/+** on the board. Slide the **+** end of the battery into the appropriate end of the holder, and then press the **-** end of the battery down until the entire battery is secure in the holder.



TIP: To assist in inserting the battery into the holder, you might need to pull the contacts slightly outward.

8. Replace the lid on the base, and insert and tighten the screws. Do not over tighten.



For maximum battery life, fully charge the batteries before placing them into service for the first time. Failing to fully charge the batteries may result in reduced battery life and cause premature battery failure.

9. See page 42 for the steps to charge the new batteries.

Annual Calibration

See the *Product Information Bulletin* included with your shipment for information on ETS-Lindgren calibration services.

Replacement and Optional Parts



ETS-Lindgren may substitute a similar part or new part number with the same functionality for another part/part number. Contact ETS-Lindgren for questions about part numbers and ordering parts.

Following are the part numbers for ordering replacement or optional parts for the Model 3301C Active Monopole Antenna.

REPLACEMENT PARTS

Part Description	Part Number
Monopole Element	<ul style="list-style-type: none">• 116476 Monopole, entire assembly• 116474 Rod section without antenna adapter• 116862 Center section

Note: 116474 Rod section with antenna adapter is not a replaceable part; if you need that section, you will need to order the entire monopole assembly, 116476.

Counterpoise, Half (2)	114670
Knobs, Counterpoise (4)	910051
AC Adapter	H-30DTS050
Rechargeable AA NiMH Batteries, 2000 mAh (8)	400042
Cordset, 6 ft, IEC 320-C7 to NEMA 5-15	670059

OPTIONAL PARTS (EACH SOLD SEPARATELY)

Part Description	Part Number
3301C Calibration Fixture (10pF)	3301CAL-A
3301C Calibration Fixture (12pF)*	3301CAL-B*
Tripod, Non-Conductive, 1M, Light	4-TR, 1ML
3301C CISPR Adapter†	119814†

*Required in order to meet CISPR 16-1-6: 2017 and ANSI 63.5: 2017

†Decouples the coax ground from the chassis for CISPR testing.

Service Procedures

For the steps to return a system or system component to ETS-Lindgren for service, see the *Product Information Bulletin* included with your shipment.

This page intentionally left blank.

3.0 Specifications

Operational Specifications

Frequency Range:	30 Hz to 50 MHz (maximum usable bandwidth)
Low Frequency Roll Off:	The low frequency roll off is switch-selectable to be 3 dB down at 22 kHz, 1.9 kHz, or 170 Hz.
High Frequency Roll Off:	Antenna factor is 3 dB down at 30 MHz
Antenna Factor:	<ul style="list-style-type: none">• See data chart on page 54.• Unless otherwise noted, the low frequency roll off is set at the 170 Hz 3 dB roll off point
Saturation Level:	<ul style="list-style-type: none">• 0.8 V/m narrowband without attenuation• 25 V/m with 30 dB of internal attenuation selected• 63 dBuV/m/MHz broadband saturation level
Minimum Discernible Signal:	<ul style="list-style-type: none">• See data chart on page 56.• For best sensitivity all internal attenuation should be turned off
Dynamic Range:	<ul style="list-style-type: none">• 111 dB at mid-band (1 MHz)• 141 dB with the use of the internal attenuators

Saturation Indicator Impulse Response:	<p>The saturation indicator will properly indicate saturation for pulsed signals which fall within the following boundaries:</p> <ul style="list-style-type: none"> • The product of the pulse width to pulse repetition rate must be greater than 0.003. • The pulse repetition rate must be less than value listed for the applicable duty cycle. See the following <i>Table of Acceptable Pulse Repetition Rates</i>.
---	--

TABLE OF ACCEPTABLE PULSE REPETITION RATES

<u>Duty Cycle</u>	<u>Maximum PRF</u>
10	19.7 MHz
20	14.0 MHz
30	9.2 MHz
40	5.6 MHz
50	420.0 kHz
60	130.0 kHz
70	87.0 kHz
80	57.0 kHz
90	30.0 kHz

Electrical Specifications

Output Impedance:	50 Ω (nominal)
BNC Connector:	For 50- Ω cable

Physical Specifications

Size:	<ul style="list-style-type: none">• Length: 19.05 cm (7.5 in)• Width: 19.05 cm (7.5 in)• Height: 8.89 cm (3.5 in)• Weight (Antenna base only): 1.4 kg (3.1 lb)
Tripod Mounting:	1/4–20 hole on the base
Monopole Element:	<ul style="list-style-type: none">• For a finished length of 40.95 in (1040 mm)—Assemble (2) 116474 rod sections and (1) 116862.• For a finished length of 39.37 in (1000 mm)—Assemble (2) 116474 rod sections. Do not use the 116862 center section. <p>See page 26 for the steps to assemble the monopole.</p>

AC Adapter & Battery Specifications

Battery*:	<ul style="list-style-type: none">• Rechargeable AA Nickel-Metal Hydride batteries (8)• 2000 mAH recommended
Battery Charge Time:	Approximately 3.5 hours, depending on charge level of batteries
Battery Operating Time (Typical):	Approximately 30 hours
Input Rating:	Nominal 90–265 VAC 50/60 Hz
Adapter Output Power:	20W
Temperature Range:	-20°C to 40°C -4°F to 104°F
Dimensions:	<ul style="list-style-type: none">• Length: 19.05 cm (7.5 in)• Width: 19.05 cm (7.5 in)• Height (from feet to thumbscrews): 8.9 cm (3.5 in)• Weight (antenna base only): 1.4 kg (3.1 lb)

*It is recommended that batteries are replaced every two years.

4.0 Assembly Instructions

CAUTION

Before connecting any components, follow the safety information in the ETS-Lindgren *Product Information Bulletin* included with your shipment.



The 1/4–20 mount on the bottom of the Model 3301C Active Monopole Antenna is not a ground location.



See *Mounting Instructions* on page 31 for information on mounting the Model 3301C. For information on using the MIL-STD-461F/G Test Kit, see page 28.

Counterpoise and Monopole Element

The counterpoise is designed to be placed on top of the Model 3301C. This prevents the body of the unit from intruding into the field to be measured.

CAUTION

Do not lift the Model 3301C by the counterpoise.



For protection of the antenna field-effect transistor (FET), it is recommended that you use an electrostatic discharge (ESD) wrist strap at an ESD-protective workstation for complete grounding.

1. Place the power switch in the OFF/CHG position.
2. Touch the two grounding strips located on top of the Model 3301C.

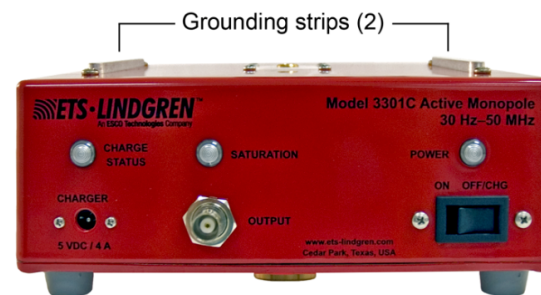

3. If not already in place, insert one thumbscrew knob into each of the holes in the grounding strips. Slightly tighten the thumbscrew knobs.

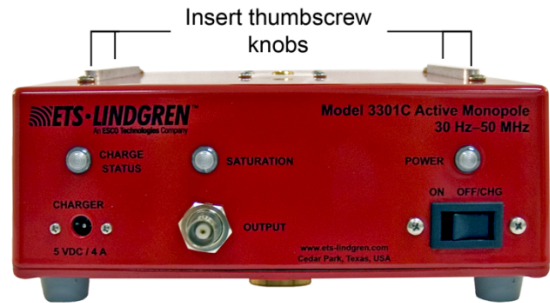

➔ There is no need to ever remove the thumbscrews from the grounding strips; you may leave them inserted and tightened securely. If you do remove the thumbscrews, make sure to place them in a safe, retrievable location.

➔ **Tip:** The two halves of the counterpoise fit together as shown.

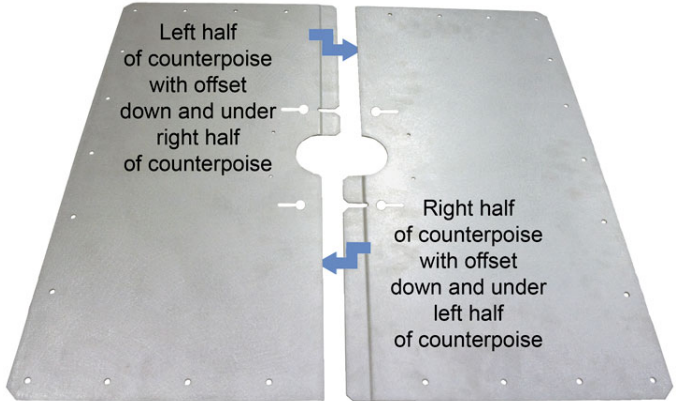

- 4. Attach left half of counterpoise to grounding strips:** Fit the keyhole slots over the two thumbscrew knobs located at the back of the Model 3301C.

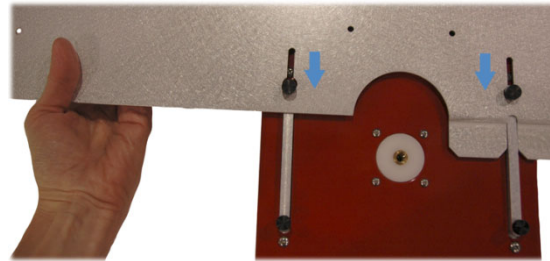

Slide the counterpoise forward so that the thumbscrew knobs are flush with the ends of the slots.

- 5. Attach right half of counterpoise to grounding strips:** Fit the keyhole slots over the two thumbscrew knobs located at the front of the Model 3301C.

At the same time, fit the right half of the counterpoise with the left half.

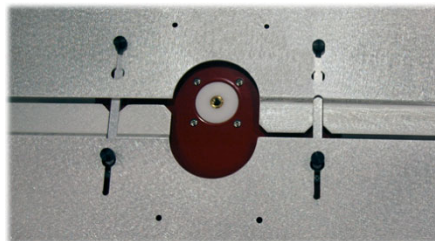

Fit keyhole slots over thumbscrews;
at the same time, fit the two halves
of counterpoise together

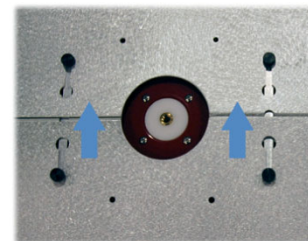

Slide right half
of counterpoise
towards back

Slide the right half of the counterpoise towards the back of the Model 3301C so that the thumbscrew knobs are flush with the ends of the slots.

- 6. Tighten all four thumbscrew knobs.**

7. Assemble the monopole element:

- **For a finished length of 40.95 in (1040 mm)**—Assemble (2) 116474 rod sections and (1) 116862 center section.
- **For a finished length of 39.37 in (1000 mm)**—Assemble (2) 116474 rod sections. Do not use the 116862 center section.

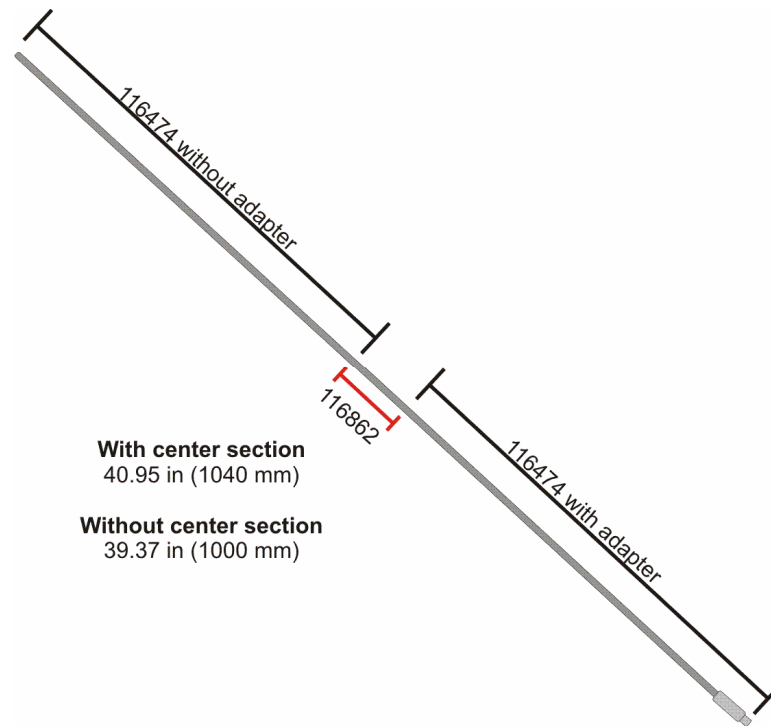

8. Insert the monopole through the hole in the counterpoise and into the antenna base. Rotate the monopole to tighten.

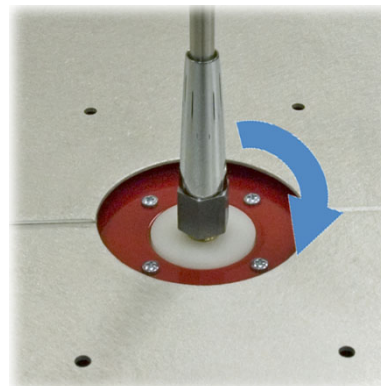

9. Connect the output of the unit to a 50-ohm receiver, spectrum analyzer, or RF voltmeter.
10. Press the power switch to the left to turn on power to the Model 3301C. The power LED displays green when the unit is on. For complete information on the front panel controls and indicators, see *Operation* on page 35.

MIL-STD-461F/G Test Kit

The MIL-STD-461F/G Test Kit includes:

- BNC cable (27 in)
- Ferrite bead
- BNC bulkhead connector
- Right-angle bracket

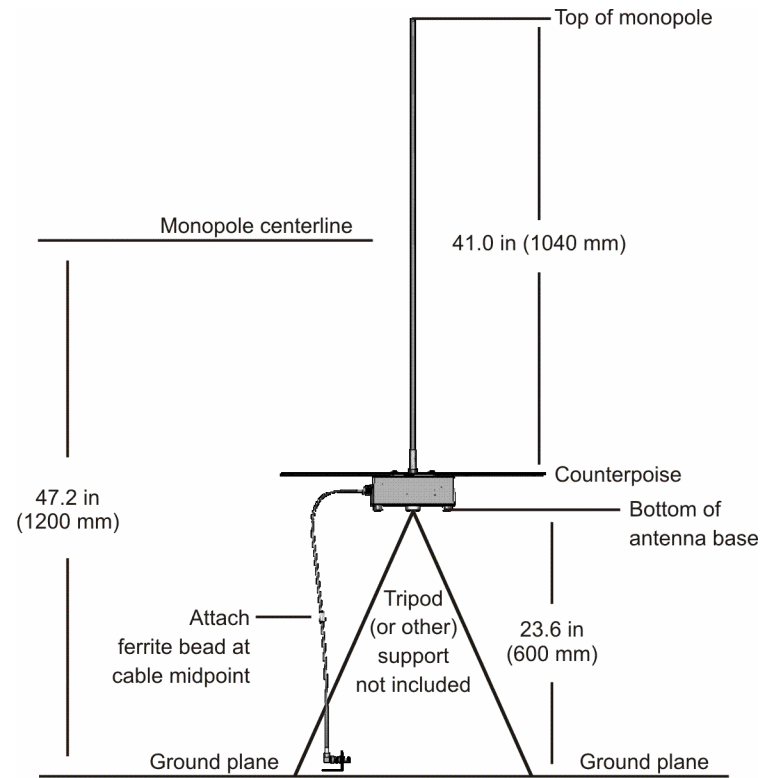

To assemble the MIL-STD-461F/G Test Kit:

1. Disconnect the Model 3301C from power.
2. Attach the ferrite bead at the midpoint of the BNC cable.
3. Attach the angle bracket to the ground plane (screws not included).
4. Plug the BNC cable into the **Output** on the Model 3301C.
5. Plug the other end of the BNC cable into the BNC bulkhead connector in the right-angle bracket.

This page intentionally left blank.

5.0 Mounting Instructions

CAUTION

Before connecting any components, follow the safety information in the ETS-Lindgren *Product Information Bulletin* included with your shipment.

CAUTION

The Model 3301C is a precision measurement device. Handle your antenna with care.

4-TR Light Tripod Mounting Options (Sold Separately)

Use the 1/4–20 mount on the bottom of the Model 3301C Active Monopole Antenna to mount directly onto an ETS-Lindgren 4-TR Light Tripod; no additional hardware is required.

7-TR and Mast Mounting Options (Sold Separately)

Following are options for mounting the Model 3301C onto an ETS-Lindgren 7-TR Tripod or mast. Contact the ETS-Lindgren Sales Department for information on ordering optional mounting hardware.

Mast refers to 2070 Series, 2075, and 2175 Antenna Towers.

7-TR refers to 109042, 108983, and 108507 booms:

- *109042 boom*—Straight boom; for general antenna mounting on a 7-TR
- *108983 boom*—Offset boom; for general antenna mounting on a 7-TR with pneumatic or manual polarization; can also be used to mount stinger-type antennas
- *108507 boom*—For Model 3106 Series antennas only; when changing polarization, maintains centerline rotation

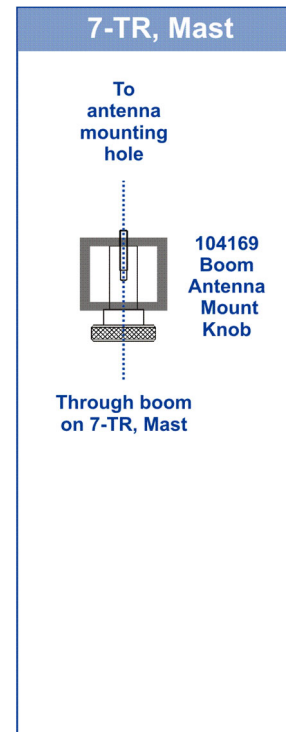

2x2 Boom Mounting Options (Sold Separately)



2x2 boom refers to a typical 2-inch by 2-inch boom.

Following are options for mounting the Model 3301C onto a 2x2 boom. Contact the ETS-Lindgren Sales Department for information on ordering optional mounting hardware.

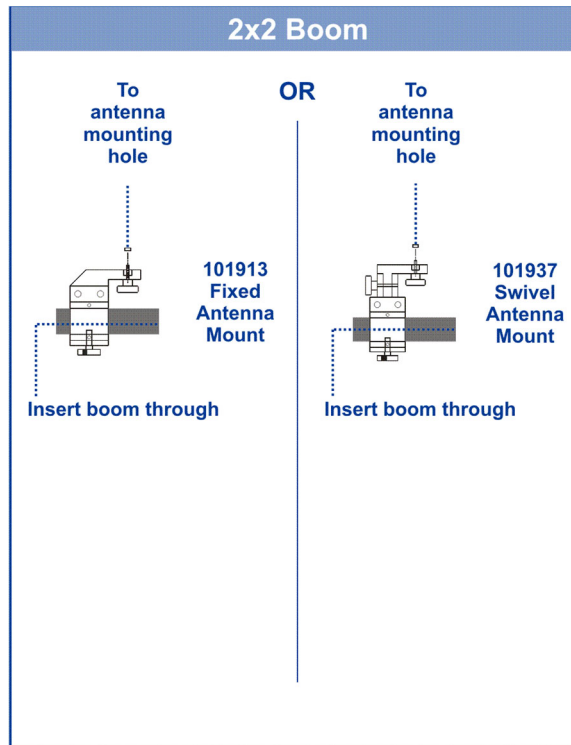

This page intentionally left blank.

6.0 Operation

CAUTION

Before connecting any components, follow the safety information in the ETS-Lindgren *Product Information Bulletin* included with your shipment.

Front Panel Controls and Indicators



When you turn on the Model 3301C, the saturation and power lights will blink and an audible alarm will sound for five to eight seconds.

CHARGE STATUS LED

State of LED	Indicates
No light (off)	<ul style="list-style-type: none">The AC adapter is not connected to the Model 3301C.The AC adapter is plugged into the Model 3301C, but is not connected to power.
Blue, steady	The AC adapter is in the process of charging the batteries.
Blue, blinking	The AC adapter is in top off mode; no action required.

State of LED	Indicates
Green	The batteries are charged. You may disconnect the AC adapter from the Model 3301C.
Red	Fault condition. If this occurs, disconnect the AC adapter from the Model 3301C, and then re-connect the AC adapter; CHARGE STATUS should now display a steady blue light. If the red light persists, contact ETS-Lindgren Customer Service.

CHARGER CONNECTOR

The charger connector is used to recharge the Nickel Metal Hydride (NiMH) batteries. To charge the Model 3301C, set the power switch to OFF/CHG and plug in the AC adapter. The charging circuit will not charge the batteries when the Model 3301C is on. For more information, see *Charging the Batteries* on page 42.

SATURATION LED

The saturation LED indicates that the amplitude of the signal has reached the limits of the internal amplifier, after which the output signal will be distorted. The saturation indicator will blink red and the unit will beep when the Model 3301C is in saturation. Do not take readings when the unit is in saturation.



If saturation occurs, apply internal attenuation by changing the DIP switch settings. See *DIP Switches* on page 38 for more information.

Impulsive-type signals may put the Model 3301C into a non-linear region without triggering the saturation circuit. When dealing with impulsive-type signals, strictly observe the 63 dBu V/m/MHz limit. If a signal exceeds this limit, apply internal attenuation.

The unit output capability is the limiting factor in handling impulsive-type signals. Once the internal attenuators are engaged, most higher-impulsive signals may be measured. For example, with the 30 dB attenuator engaged, a 93 dBuV/m/MHz signal may be measured.

OUTPUT CONNECTOR

Plug a 50-ohm BNC cable into this connector. Connect the other end of the cable to the required monitoring equipment.

To isolate the BNC cable shield from the 3301C chassis, install the optional CISPR adapter (part number 119814) between the output connector and the monitoring equipment cable. The insertion loss of the adapter is less than 0.5 dB from 30 Hz to 30 MHz.

POWER LED



See page 42 for the steps to charge the batteries.

State of LED	Indicates
Green, steady	Power is on.
Green, blinking	Batteries are low. Data produced in this condition may be invalid. Suspend testing and charge the batteries.
No light (off)	Unit is in shut off mode. If the unit is switched on and the power LED is off, the batteries may be depleted. Charge or replace the batteries.

POWER SWITCH

The power switch operates as an on/off switch for Model 3301C and the battery charging function. When you are using the Model 3301C, the switch should be set to ON. When the Model 3301C is off or you are charging the batteries, the switch should be set to OFF/CHG.

DIP Switches

FOR INTERNAL ATTENUATION / LOW FREQUENCY ROLL OFF

The Model 3301C is calibrated and shipped with all internal attenuation DIP switches set to OFF, except DIP switch 22.0 kHz, which should be set to ON. To change DIP switch settings, see the steps on page 41.

A bank of four DIP switches located at the SW2 designation on the system board slide to control the internal attenuation and the low frequency roll off.

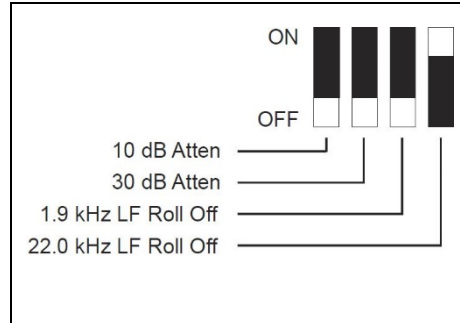

10 dB Atten—Adds 10 dB of internal attenuation (+/- 10%)

30 dB Atten—Adds 30 dB of internal attenuation (+/- 10%)

1.9 kHz LF Roll Off—Sets the low frequency roll off of 3 dB down at 1.9 kHz

22.0 kHz LF Roll Off—Sets the low frequency roll off of 3 dB down at 22 kHz

Proper Selection of Internal Attenuation

When dealing with continuous wave (CW) signals, no attenuation is needed to measure field strengths below 0.8 V/m. At approximately this level, the saturation indicator light will illuminate, indicating a need to switch on the 10 dB attenuator.

When the 10 dB attenuator or 30 dB attenuator is switched on, the Model 3301C can measure field strengths up to 2.5 V/m or 25 V/m respectively without saturating. The unit retains 111 dB of dynamic range, but the maximum reading before saturation is raised by 10 dB or 30 dB while the minimum discernible signal is also raised by 10 dB or 30 dB. At 2.5 V/m, with the 10 dB attenuator active, the saturation indicator light will again illuminate. This indicates a need to switch the 30 dB attenuator on in place of the 10 dB attenuator.

When using either of the attenuators, make sure to add the attenuation to the antenna factor for accurate readings. Also, note that if both attenuator switches are used, the resulting attenuation is approximately 31 dB.

Both of the internal attenuators have a 10% tolerance, so they should be calibrated before being used in critical applications.

For High Sensitivity Readings

The Model 3301C is optimized to facilitate extremely sensitive readings. For the most sensitive applications, all internal attenuation should be off. The noise limiting factor on the Model 3301C is the high front end impedance presented to the front end of the wideband amplifier.

The signal graphs provided in *Data and Illustrations* on page 49 represent the smallest signal which can be detected with the Model 3301C.

The data plotted are the noise output of the unit. As a result, this forms the noise measurement for a signal plus noise to noise ratio of 3 dB.

$$\frac{(S + N)}{N}$$

Several typical bandwidths are presented. To calculate the expected sensitivity at another bandwidth, a **10log** relation should be used.

Example

Determine the sensitivity with a 3 kHz bandwidth at 1 MHz:

- The minimum discernible signal (MDS) at 1 MHz with a 1 kHz bandwidth is read from the graph at **7 dBuV/m**
- The ratio of the bandwidth is **3/1=3**
- Taking **10log(3)** results in **4.77 dB**
- Therefore, the expected sensitivity would be **7 dBuV/m+4.77dB=11.77dBuV/m**

ALARM DIP SWITCHES



When you turn on the Model 3301C, the saturation and power lights will blink and an audible alarm will sound for five to eight seconds.

The Model 3301C is shipped with all active alarm DIP switches set to ON. To change DIP switch settings to disable the beep, see the steps on page 41.

A bank of four DIP switches located at the SW1 designation on the system board slide to control the audible settings for the saturation and power alarms.

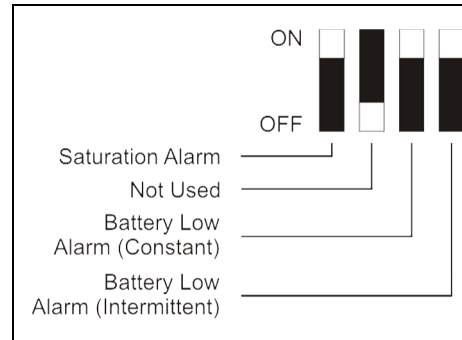

Saturation Alarm—Audible alarm for saturation condition

Not Used—Inactive

Battery Low Alarm (Constant)—Continuous audible alarm for power/battery low condition

Battery Low Alarm (Intermittent)—Intermittent audible alarm for power/battery low condition

CHANGE DIP SWITCH SETTINGS

CAUTION

Before performing these steps, follow the safety information in the ETS-Lindgren *Product Information Bulletin* included with your shipment.



The DIP switches for internal attenuation and low frequency roll off are located on the system board at designation SW2, and the DIP switches for the audible alarms are located at designation SW1.

1. Place the power switch in the OFF/CHG position. See *Operation* on page 35 for information on the front panel controls and indicators.
2. Remove the monopole element and counterpoise. See *Counterpoise and Monopole Element* on page 23 for more information.
3. Disconnect all cables from the antenna base.
4. Turn over the Model 3301C antenna base and place it on a stable surface with the bottom facing up.
5. Use a Phillips screwdriver to remove the eight screws from around the perimeter of the base. Lift the lid to remove it from the base and to access the system board.
6. Change the DIP switch settings as required.
7. Replace the lid on the base, and insert and tighten the screws. Do not over tighten.
8. Reassemble and re-connect the cables.

Charging the Batteries

CAUTION

Never attempt to recharge a non-rechargeable battery.



For maximum battery life, fully charge the batteries before placing the Model 3301C into service for the first time. Failing to fully charge the batteries may result in reduced battery life and cause premature battery failure.



If the unit may be idle (shelved and unused) for more than a month, remove the batteries and store them separately. Check them before reinstalling them in the unit and install fresh batteries if necessary.

1. Move the power switch on the Model 3301C to OFF/CHG; if the power switch is set to ON, the batteries will not charge.
2. Connect the AC adapter to the electrical mains, and then plug the adapter into CHARGER on the Model 3301C.

For the steps to replace the batteries, see *Battery Replacement* on page 13. Batteries should be replaced every two years.

7.0 Calibrating the Model 3301C

CAUTION

Before connecting any components, follow the safety information in the ETS-Lindgren *Product Information Bulletin* included with your shipment.

The ETS-Lindgren calibration fixture Calibration Fixtures (sold separately) incorporates a resistive T network and a capacitor to perform the Equivalent Capacitive Substitution Method (ECSM) of calibration for rod antennas. The T allows for accurate reading of the input to the calibration fixture, and the capacitor feeds the amplifier through the same impedance as the rod. Select the calibration fixture (3301CAL-A or 3301CAL-B) based on the individual calibration requirements of your specific test.



Calibration Steps

Depending on your calibration configuration, see *Model 3301C Calibration With Receiver and Signal Generator* on page 46 or *Model 3301C Calibration With Network Analyzer* on page 47.

1. Disconnect the Model 3301C Active Monopole Antenna from power.
2. Remove the monopole element.

3. Insert the mounting stud on the back of the calibration fixture into the Model 3301C rod element mounting hole. Rotate to tighten.

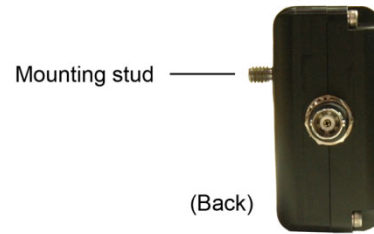

Insert mounting stud into rod element mounting hole and rotate to tighten

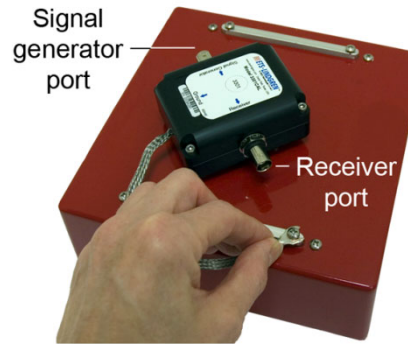

Connect ground to counterpoise mounting screw

4. Connect the calibration fixture ground to one of the counterpoise mounting screws on the Model 3301C.
5. Place a signal source on the signal generator port of the calibration fixture and a receiver on the receiver port.
6. Terminate the output of the Model 3301C with 50Ω , and record the input signal strength.
7. **Compensate for test fixture and effective height of antenna:** The receiver port on the 3301CAL has approximately 5 db loss in signal strength from the mounting stud due to the resistor network in the fixture. In addition, the effective height of the monopole is to be considered. This adds a correction factor (1.04-meter = 5.6 dB, 1.00-meter = 6 dB), making a combined correction factor of 10.6 dB to 11 db depending on the length of the monopole used.

8. Move the receiver cable to the output port on the Model 3301C, and then place a 50 Ω load on the receiver port of the calibration fixture.
9. Read the output signal. The antenna factor is the input signal (read from the receiver port on the calibration fixture) plus the combined correction factor of 11 dB, minus the output signal (read from the output port on the Model 3301C). Both readings are assumed to be logarithmic.

Model 3301 Calibration With Receiver and Signal Generator



Attenuators may be required if VSWR of the receiver or signal generator is high.

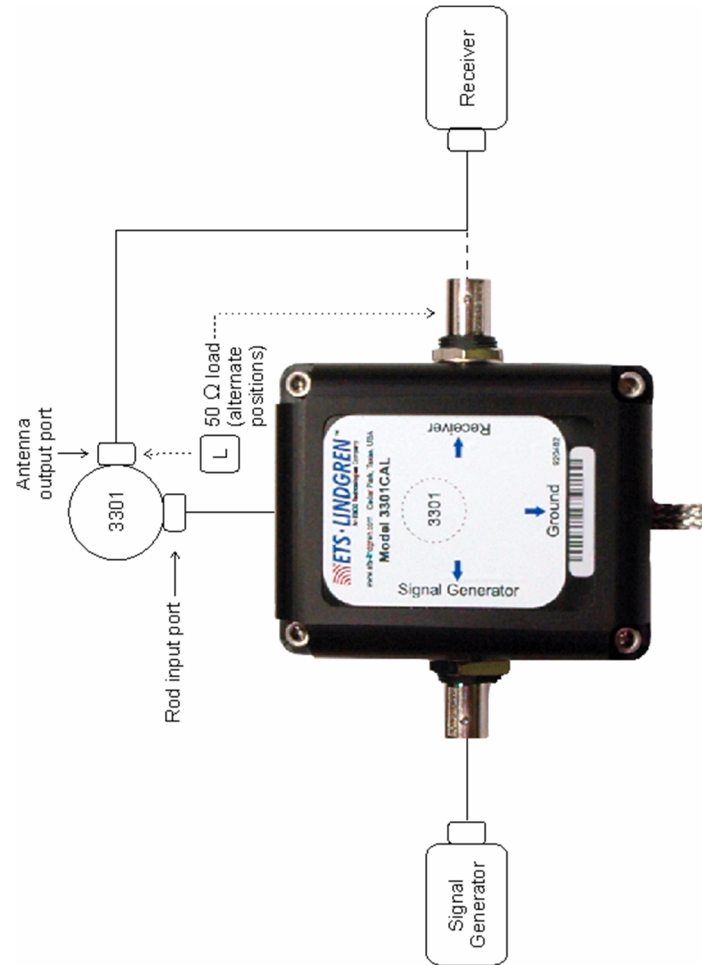

Model 3301 Calibration With Network Analyzer



Attenuators are not required with a network analyzer.

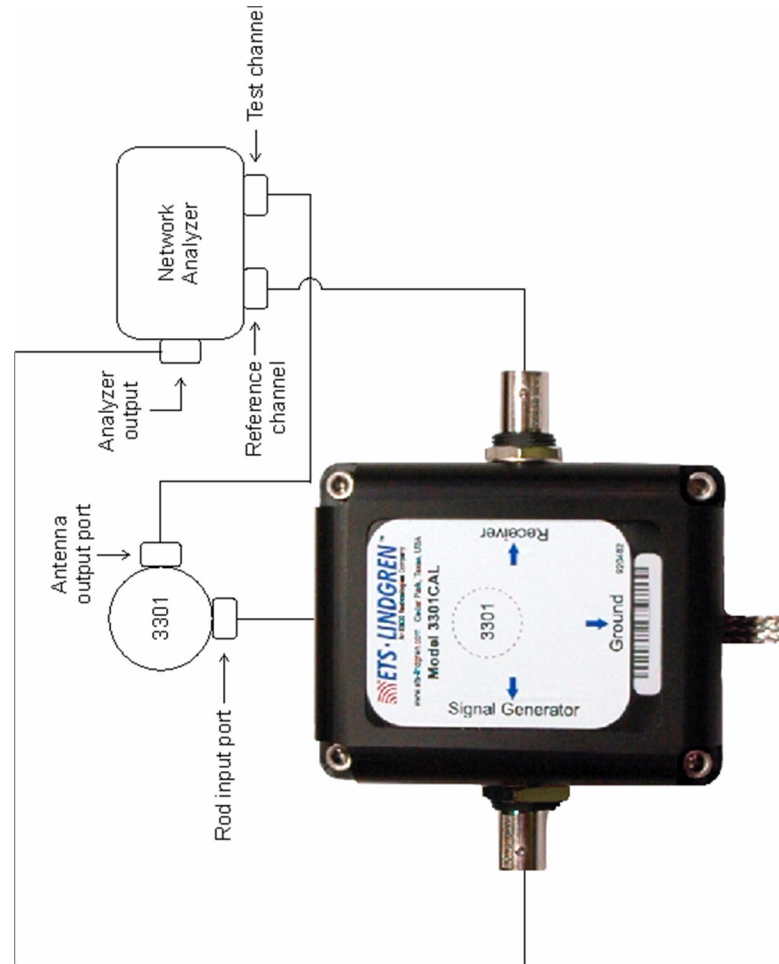

Example of Antenna Factors Calculation with 1 meter Monopole

1. The input read from the calibration fixture receiver port is 50 dB μ V.
2. The output read from the Model 3301C output port is 59 dB μ V.
3. The antenna factor is the input plus the combined fixture loss and effective height correction factor, minus the output. Assuming a reading is taken with a 1-MHz signal input to the calibration fixture and a combined correction factor of 11 dB:

$$50 \text{ dB}\mu\text{V} + 11 \text{ dB (1/m)} - 59 \text{ dB}\mu\text{V} = 2 \text{ dB (1/m)}$$

8.0 Data and Illustrations

Periodic Rectangular Pulse Train

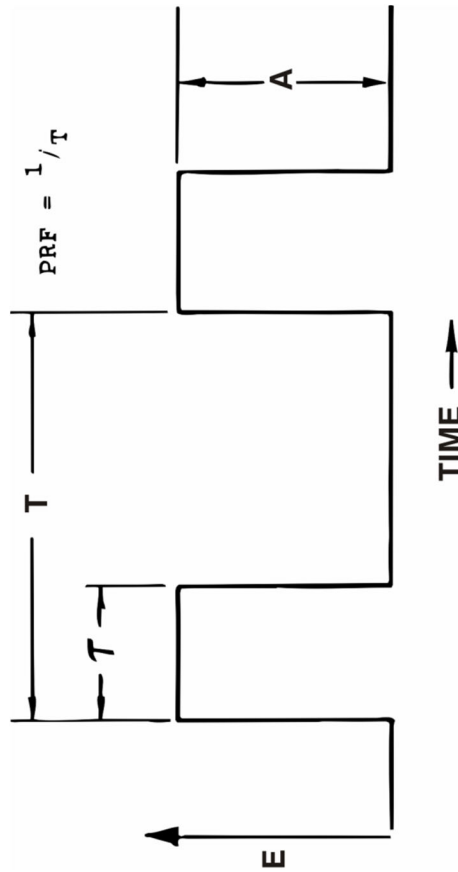

Spectrum of Rectangular Pulse

Amplitudes and phases of an infinite number of harmonics are required to fully describe the envelope.

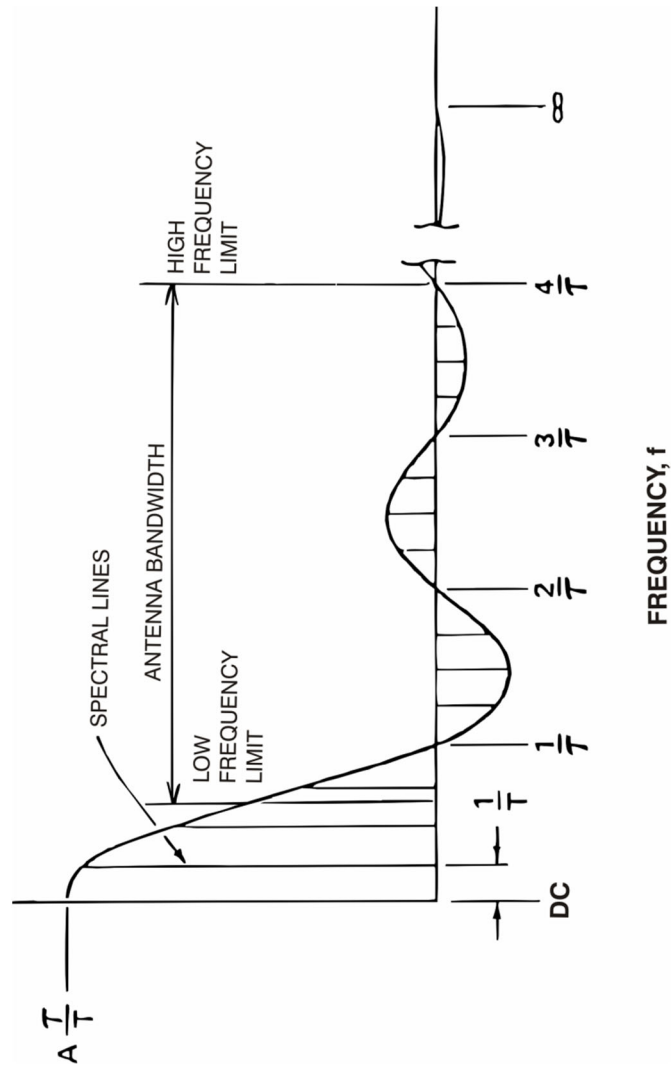

Altering Pulse Width / Pulse Repetition Rate

The following figures A–D depict the effect of altering either the pulse width or pulse repetition rate. A narrow pulse width (A, C) spreads the pulse energy over a wider frequency band. Wider pulses (B, D) cause narrower lobes. A low pulse repetition rate (A, B) creates widely spaced spectral lines. Faster rates (C, D) increase the spectral line density.

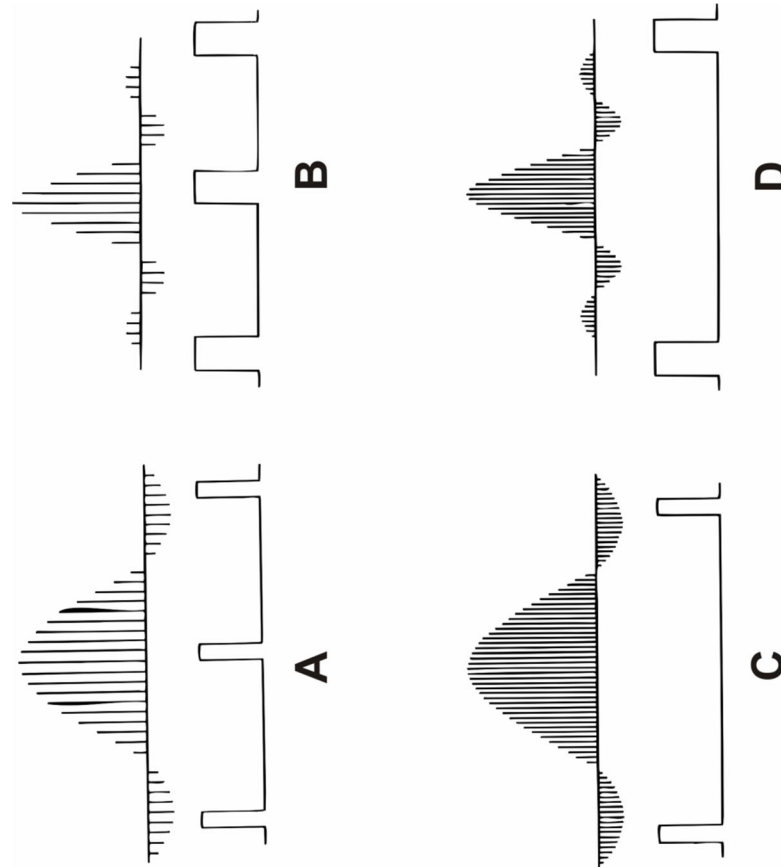

Active Electric Field Antenna Calibration Fixture

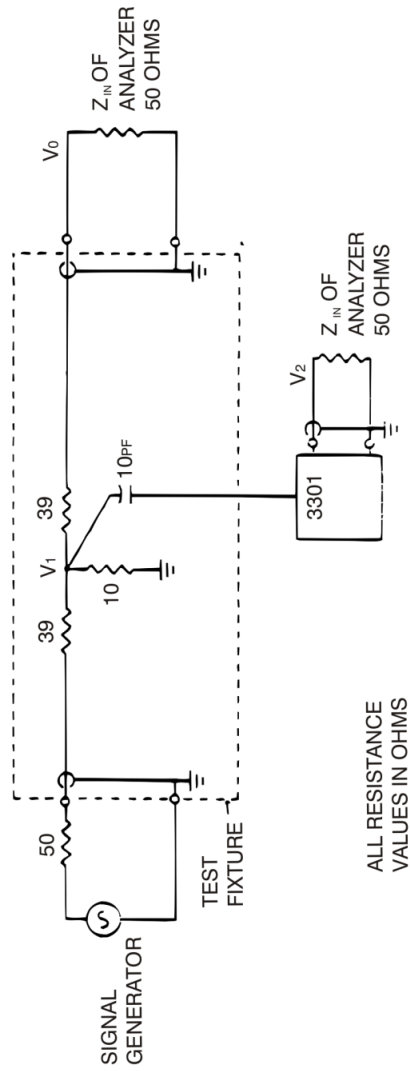

Active Monopole Antenna Calibration Setup

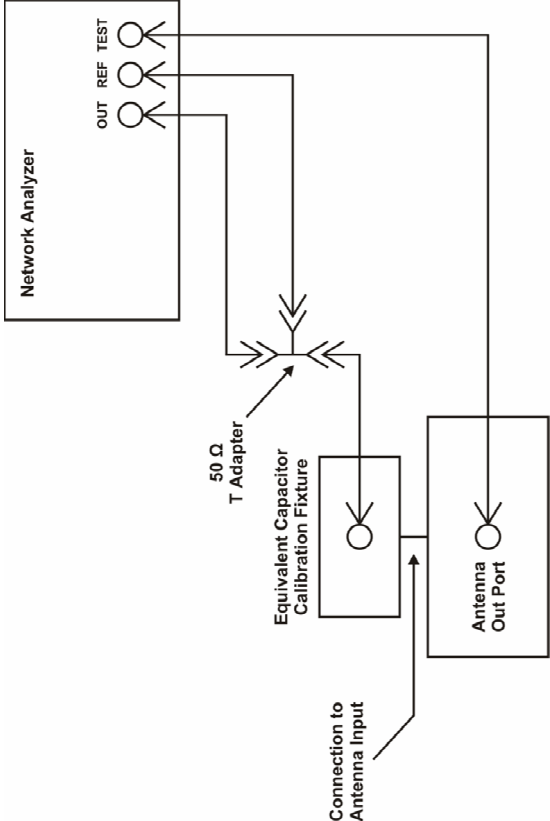

Typical Curves—Typical Antenna Factors at the Default Switch Position (All Off)

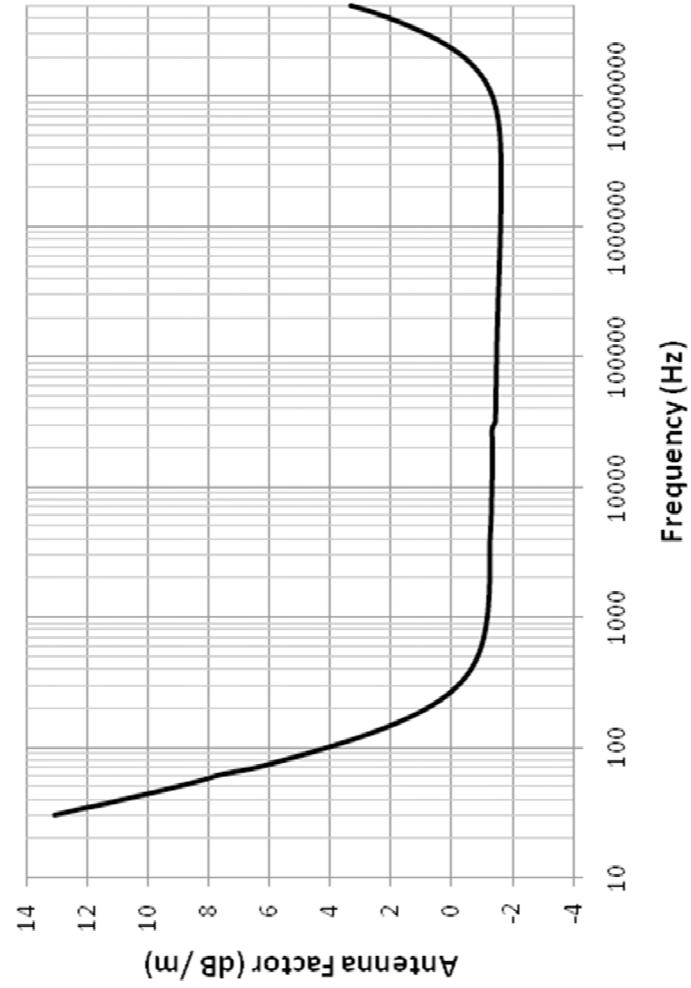

Typical Curves—Typical Maximum Noise Voltage
Using 10 Hz Bandwidth

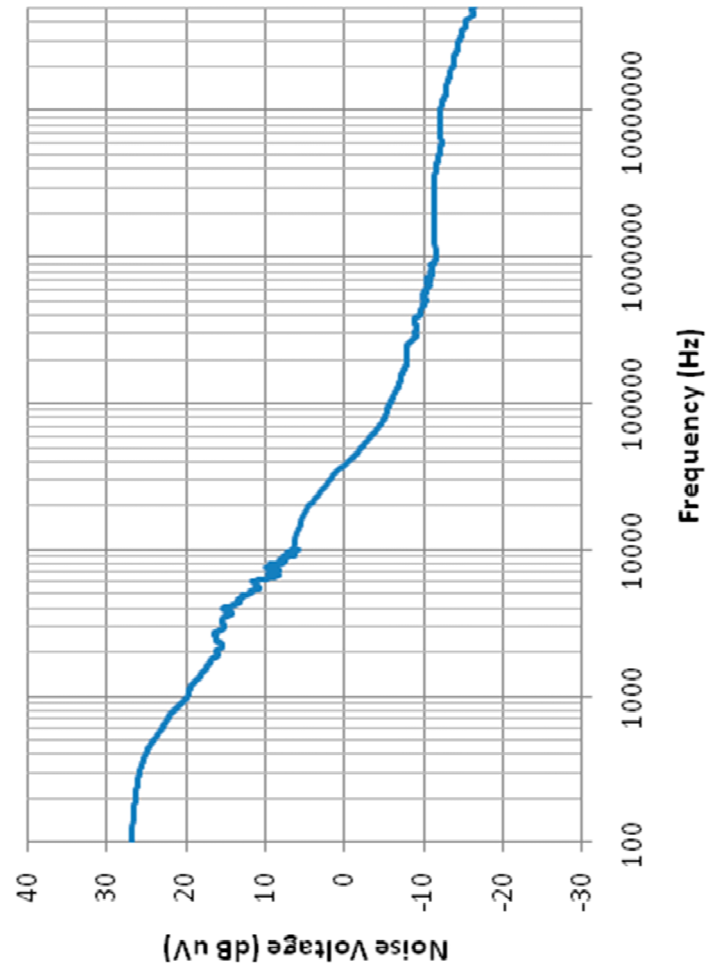

Typical Curves—Typical Minimum Discernable Electric Field Levels (dB uV/m) Under Different Bandwidths

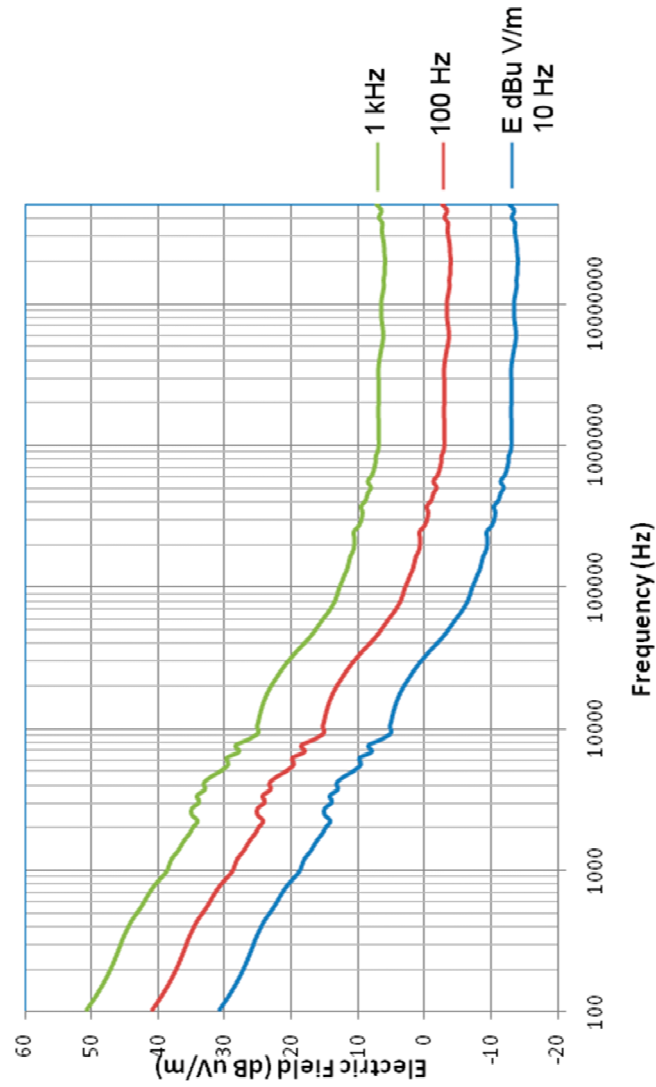

Typical Antenna Factors for Different Switch Configurations

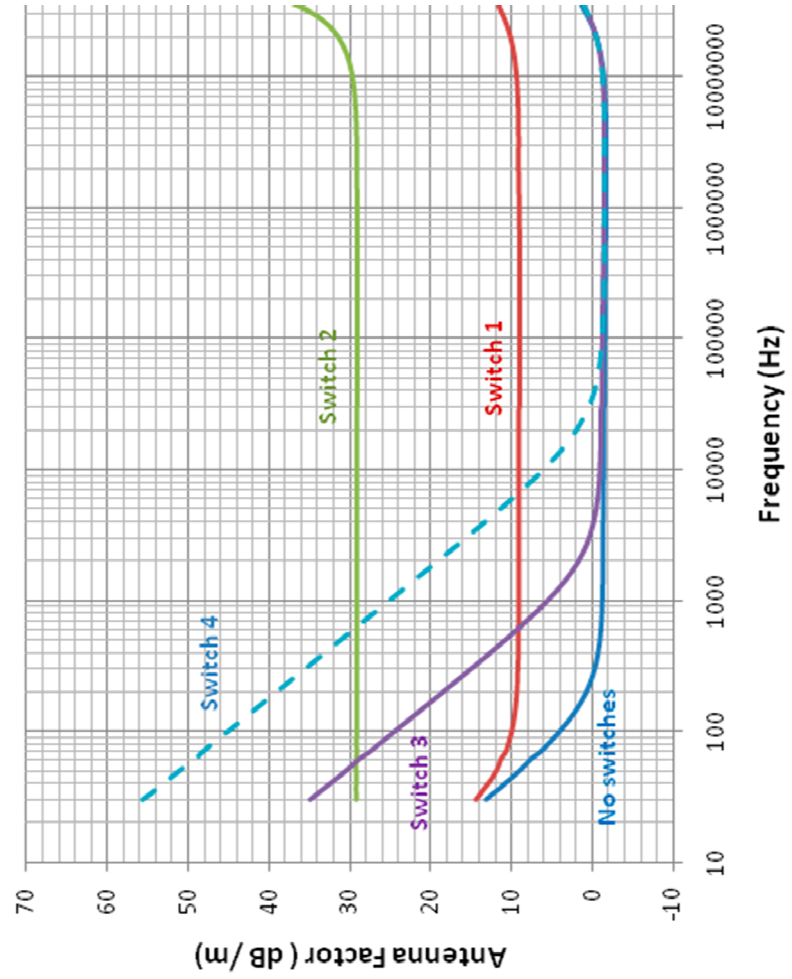

This page intentionally left blank.

Appendix: EC Declaration of Conformity

The EC Declaration of Conformity is the method by which ETS-Lindgren Inc. declares that the equipment listed on this document complies with the EMC Directive and Low Voltage Directive.

Factory

ETS-Lindgren Inc.
1301 Arrow Point Drive
Cedar Park, TX, USA 78613

Issued by

ETS-Lindgren Inc.
1301 Arrow Point Drive
Cedar Park, TX, USA 78613

The products listed below are eligible to bear the CE mark:

– Model 3301C Active Monopole Antenna

APPLICABLE REQUIREMENTS

Standard	Criteria
<u>EMC Directive (2004/108/EC)</u>	
EN 61326	–Electrical Equipment for Measurement, Control and Laboratory Use; EMC Requirements (1997).
EN 55011	– CISPR 11 (1990) ed.2 – Threshold values and measuring methods for radio interference by HF equipment for industrial scientific and medical purposes.
EN 61000-4-2:2009	–Testing and measurement techniques for electrostatic discharge immunity test.
EN 61000-4-3:2006+A1:2008	–Testing and measurement techniques for radiated, radio-frequency, electromagnetic field immunity test.
EN 61000-4-4	–Testing and measurement techniques for electrical fast transient/burst immunity test.
EN 61000-4-5	–Testing and measurement techniques for surge immunity test.

Standard	Criteria
EN 61000-4-6	–Testing and measurement techniques for immunity to conducted disturbances, induced by radio-frequency fields.

The Low Voltage Directive (2006/95/EEC)

EN 61010	–Safety Requirements for Electrical Equipment for Measurement, Control and Laboratory Use; General Requirements (2001).
----------	---

AUTHORIZED SIGNATORIES

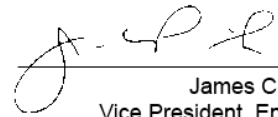

 James C. Psencik,
 Vice President, Engineering

Date of Declaration: October 23, 2009

The authorizing signatures on the EC Declaration of Conformity document authorize ETS-Lindgren Inc. to affix the CE mark to the indicated product. CE marks placed on these products will be distinct and visible. Other marks or inscriptions liable to be confused with the CE mark will not be affixed to these products. ETS-Lindgren Inc. has ensured that appropriate documentation shall remain available on premises for inspection and validation purposes for a period of no less than 10 years.