

Models 3165-01, 3165-02, 3165-04

Dual-Polarized Dual-Vivaldi Array Antenna

User Manual

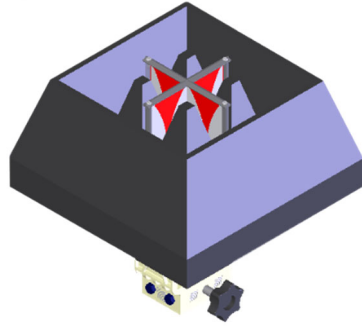

Model 3165-01-SQ

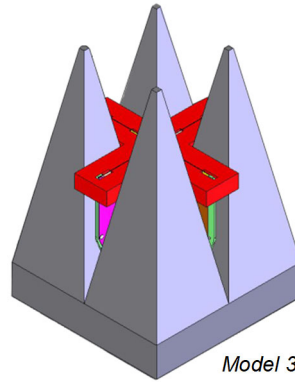

Model 3165-02-MG

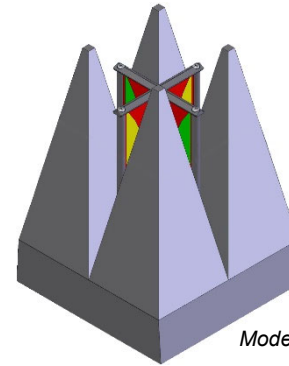

Model 3165-04

 **ETS-LINDGREN**[®]
An ESCO Technologies Company

ETS-Lindgren Inc. reserves the right to make changes to any product described herein in order to improve function, design, or for any other reason. Nothing contained herein shall constitute ETS-Lindgren Inc. assuming any liability whatsoever arising out of the application or use of any product or circuit described herein. ETS-Lindgren Inc. does not convey any license under its patent rights or the rights of others.

© Copyright 2011–2020 by ETS-Lindgren Inc. All Rights Reserved. No part of this document may be copied by any means without written permission from ETS-Lindgren Inc.

Trademarks used in this document: The *ETS-Lindgren* logo is a trademark of ETS-Lindgren Inc.; *WiMAX* is a trademark of the WiMAX Forum.

Revision Record | MANUAL,3165-01/3165-02 | Part # 399322, Rev. C

Revision	Description	Date
A	Initial Release	January, 2011
B	Added Model 3165-02 content	October, 2013
C	Added Model 3165-04 content	November, 2020

Table of Contents

Notes, Cautions, and Warnings	v
1.0 Introduction	7
Model 3165-01	8
Model 3165-02	8
Model 3165-04	8
Mounting Options	9
3165-01-MG / 3165-02-MG	9
3165-01-SQ / 3165-02-SQ	10
3165-01-RD / 3165-02-RD	10
ETS-Lindgren Product Information Bulletin	11
2.0 Maintenance	13
Annual Calibration	13
Replacement and Optional Parts	14
Service Procedures	14
3.0 Specifications	15
Electrical Specifications	15
Physical Specifications	15
3165-01 Series	15
3165-02 Series	16
3165-04 Series	17
4.0 3165-01 Typical Data	18
3165-01 Typical Gain.....	18
3165-01 Typical VSWR	19
3165-01 Typical Cross-Port Isolation.....	20
3165-01 Typical Reflectivity	21
3165-01 Typical E-Plane	22
3165-01 Typical H-Plane	23
5.0 3165-02 Typical Data	24
3165-02 Typical Gain.....	24
3165-02 Typical VSWR	25
3165-02 Typical Cross-Port Isolation.....	26

3165-02 Typical Radiation Patterns.....	27
3165-02 at 400 MHz and 500MHz.....	27
3165-02 at 600 MHz and 700 MHz.....	28
3165-02 at 800 MHz and 900 MHz.....	29
3165-02 at 1000 MHz and 1250 MHz.....	30
3165-02 at 1500 MHz and 1750 MHz.....	31
3165-02 at 2000 MHz and 2500 MHz.....	32
3165-02 at 3000 MHz and 3500 MHz.....	33
3165-02 at 4000 MHz and 4500 MHz.....	34
3165-02 at 5000 MHz and 6000 MHz.....	35
6.0 3165-04 Typical Data.....	36
3165-04 Typical Gain.....	36
3165-04 Typical VSWR	37
3165-04 Cross Pol.....	38
3165-04 Typical Radiation Patterns.....	39
3165-04 at 600 MHz and 1000MHz.....	39
3165-04 at 1500 MHz and 2000MHz.....	40
3165-04 at 2500 MHz and 3000MHz.....	41
3165-04 at 3500 MHz and 4000MHz.....	42
3165-04 at 4500 MHz and 5000MHz.....	43
3165-04 at 5500 MHz and 6000MHz.....	44
3165-04 at 6500 MHz and 7000MHz.....	45
3165-04 at 7500 MHz and 8000MHz.....	46
3165-04 at 8500 MHz and 9000MHz.....	47
3165-04 at 9500 MHz and 10000MHz.....	48

Notes, Cautions, and Warnings

	<p>Note: Denotes helpful information intended to provide tips for better use of the product.</p>
<p>CAUTION</p>	<p>Caution: Denotes a hazard. Failure to follow instructions could result in minor personal injury and/or property damage. Included text gives proper procedures.</p>
<p>WARNING</p>	<p>Warning: Denotes a hazard. Failure to follow instructions could result in SEVERE personal injury and/or property damage. Included text gives proper procedures.</p>



See the ETS-Lindgren *Product Information Bulletin* for safety, regulatory, and other product marking information.

This page intentionally left blank.

1.0 Introduction

The ETS-Lindgren 3165 Series Absorber Nested Dual-Polarized Dual-Vivaldi Array Antenna is designed for applications that require minimum effect from the source antenna, such as in chambers where the Equipment Under Test (EUT) is illuminated from different directions.

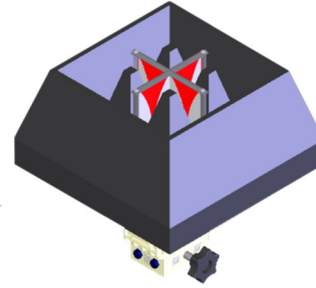

Model 3165-01-SQ

Each antenna in the 3165 Series is dual-linearly polarized and capable of simultaneously measuring two orthogonal components in the field.

The 3165 Series possesses low VSWR while maintaining high directivity. This allows use in the illumination of the EUT without affecting adjacent antennas in a multi-antenna installation.

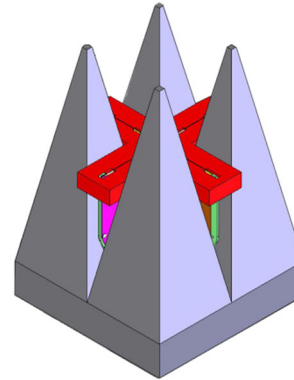

Model 3165-02-MG

Model 3165-01

The Model 3165-01 has a frequency range of 700 MHz to 6 GHz, which covers most cell phone, Wi-Fi, WiMAX™, and GPS bands. It is designed to be nested in the anechoic absorber lining of a chamber, and when installed in this configuration, will exhibit very low reflectivity, even when the input ports are mismatched. The normal incidence reflectivity is approximately -40 dB for a majority of the frequency range.

Model 3165-02

The Model 3165-02 has a frequency range of 400 MHz to 6 GHz, although it is usable to 7 GHz. The VSWR is less than 3:1 for more than 90% of the range. The 3165-02 exhibits positive gain from around 500 MHz and above, reaching gain levels of over 8 dBi above 2 GHz; the difference in gain between the two ports is extremely small (less than 0.25 dB for over 90% of the range).

Model 3165-04

The Model 3165-04 has a frequency range of 600 MHz to 10 GHz, which covers most cell phone, Wi-Fi, WiMAX™, and GPS bands.

Mounting Options

Following are the mounting options available for the 3165-01/3165-02/3165-04;
for more information on mounting, contact ETS-Lindgren Sales.

3165-01-MG / 3165-02-MG/3165-04

The MG Series allows you to magnetically attach the antenna to a positioning system, existing bracket, or shielding.

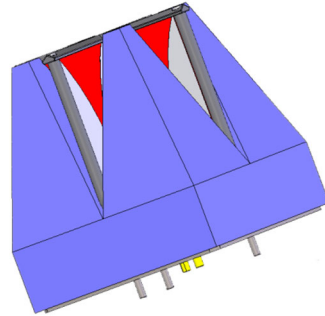

3165-01-MG

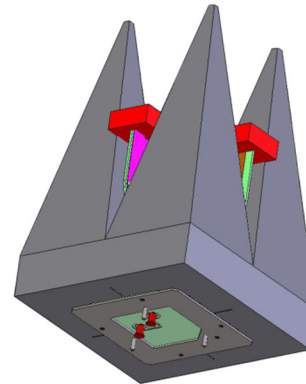

3165-02-MG

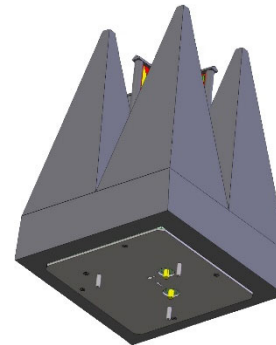

3165-04

3165-01-SQ / 3165-02-SQ

The SQ Series includes brackets that allow you to manually adjust the pan and tilt of the antenna. These brackets mount to a 50-mm square tube.

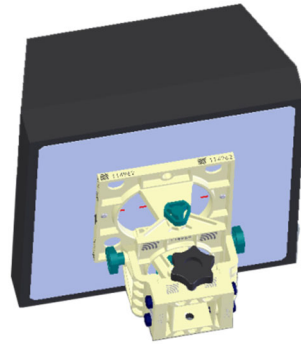

3165-01-SQ

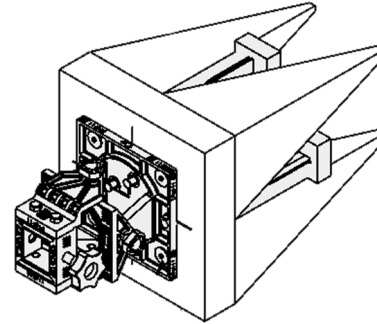

3165-02-SQ

3165-01-RD / 3165-02-RD

The RD Series includes a fixture that allows you to manually adjust the pan and tilt of the antenna. The fixture is designed to be attached to a 50-mm (diameter) round tube.

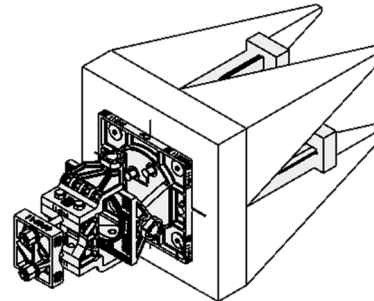

3165-02-RD

ETS-Lindgren Product Information Bulletin

See the ETS-Lindgren *Product Information Bulletin* included with your shipment for the following:

- Safety, regulatory, and other product marking information
- Steps to receive your shipment
- Steps to return a component for service
- ETS-Lindgren calibration service
- ETS-Lindgren contact information

This page intentionally left blank.

2.0 Maintenance

CAUTION

Before performing any maintenance, follow the safety information in the ETS-Lindgren *Product Information Bulletin* included with your shipment.



Maintenance of the 3165-01/3165-02 is limited to external components such as cables or connectors.

If you have any questions concerning maintenance, contact ETS-Lindgren Customer Service.

Annual Calibration

See the *Product Information Bulletin* included with your shipment for information on ETS-Lindgren calibration services.

Replacement and Optional Parts



ETS-Lindgren may substitute a similar part or new part number with the same functionality for another part/part number. Contact ETS-Lindgren for questions about part numbers and ordering parts.

Following are the part numbers for ordering replacement or optional parts for the 3165 Series Absorber Nested Dual-Polarized Dual-Vivaldi Array Antenna.

Part Description	Part Number		
	3165-01	3165-02	3165-04
Magnetic Attachment Mounting Option	3165-01-MG	3165-02-MG	3165-02-MG
Pan and Tilt Manual Adjustment Brackets (50-mm Square Tube Mounting Option)	3165-01-SQ	3165-02-SQ	3165-02-SQ
Pan and Tilt Manual Adjustment Fixture (50-mm Round Tube Mounting Option)	3165-01-RD	3165-01-RD	3165-01-RD

Service Procedures

For the steps to return a system or system component to ETS-Lindgren for service, see the *Product Information Bulletin* included with your shipment.

3.0 Specifications

Electrical Specifications

	Model 3165-01	Model 3165-02	Model 3165-04
Frequency Range:	700 MHz–6 GHz	400 MHz–7 GHz	700 MHz-10 GHz
Cross Polarization Isolation:	>25 dB		
Maximum Continuous Power:	5 Watts		
Impedance (Nominal):	50 Ω		
Connectors:	SMA female (2)		

Physical Specifications

3165-01 SERIES

	3165-01-MG	3165-01-SQ	3165-01-RD
Length:	19.0 cm 7.5 in	36.3 cm 14.3 in	36.3 cm 14.3 in
Aperture Height:	17.8 cm 7.0 in	35.5 cm 14.0 in	35.5 cm 14.0 in
Aperture Width:	17.8 cm 7.0 in	35.5 cm 14.0 in	35.5 cm 14.0 in
Weight:	1.3 kg 2.9 lb	2.6 kg 5.8 lb	2.6 kg 5.8 lb

3165-02 SERIES

	3165-02-MG	3165-02-SQ (with absorber and mounting bracket)	3165-02-RD (with absorber and mounting bracket)
LENGTH	No Absorber: 25 cm (9.8 in) With Absorber: 42 cm (18.5 in)	58 cm (22.8 in)	66 cm (26 in)
HEIGHT	No Absorber: 24 cm (9.4 in) With Absorber: 27 cm (10.6 in)	27 cm (10.6 in)	27 cm (10.6 in)
WIDTH:	No Absorber: 24 cm (9.4 in) With Absorber: 27 cm (10.6 in)	27 cm (10.6 in)	27 cm (10.6 in)
WEIGHT	1.3 kg (2.9 lb)	2.6 kg (5.8 lb)	2.6 kg (5.8 lb)

3165-04 SERIES

	3165-04	3165-04 (with absorber and mounting bracket)
LENGTH	No Absorber: 17.1 cm (6.75 in) With Absorber: 27.2 cm (10.72 in)	21.3 cm (8.4 in)
HEIGHT	No Absorber: 26.5 cm (10.45 in) With Absorber: 40.6 cm (16.0 in)	31.2 cm (12.25 in)
WIDTH:	No Absorber: 17.1 cm (6.75 in) With Absorber: 27.9 cm (11.0 in)	22.1 cm(8.7 in)
WEIGHT	0.86 kg (1.9 lb)	1.4 kg (3.0 lb)

4.0 3165-01 Typical Data

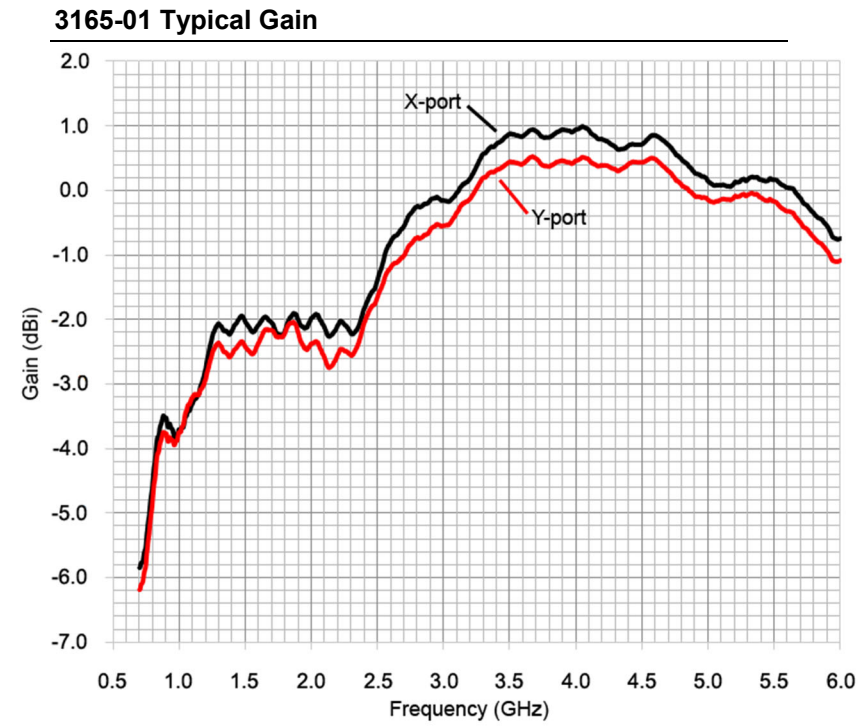

3165-01 Typical VSWR

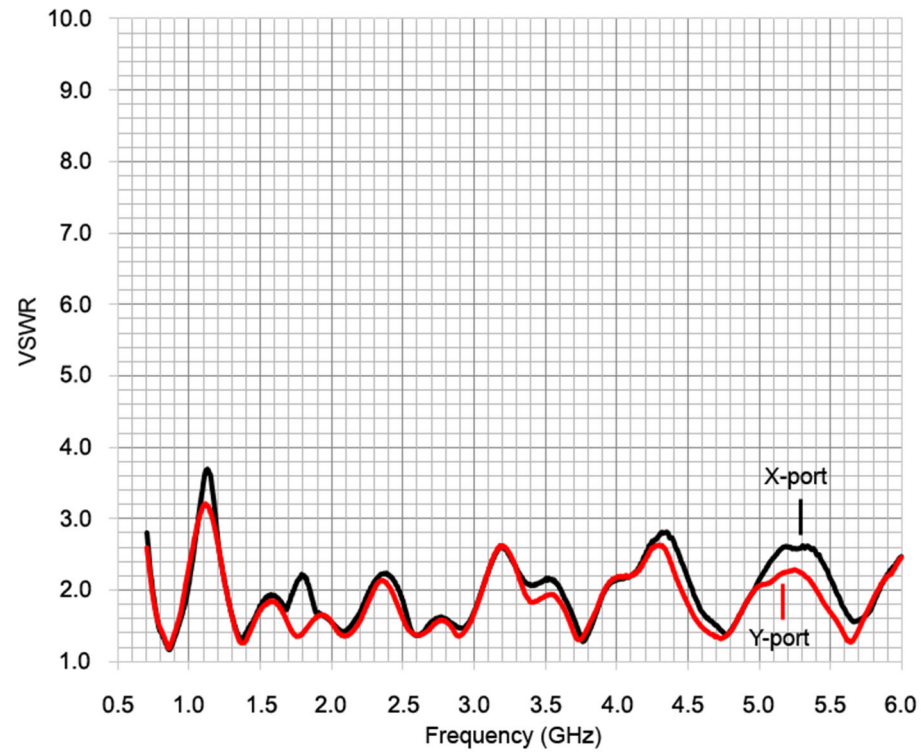

3165-01 Typical Cross-Port Isolation

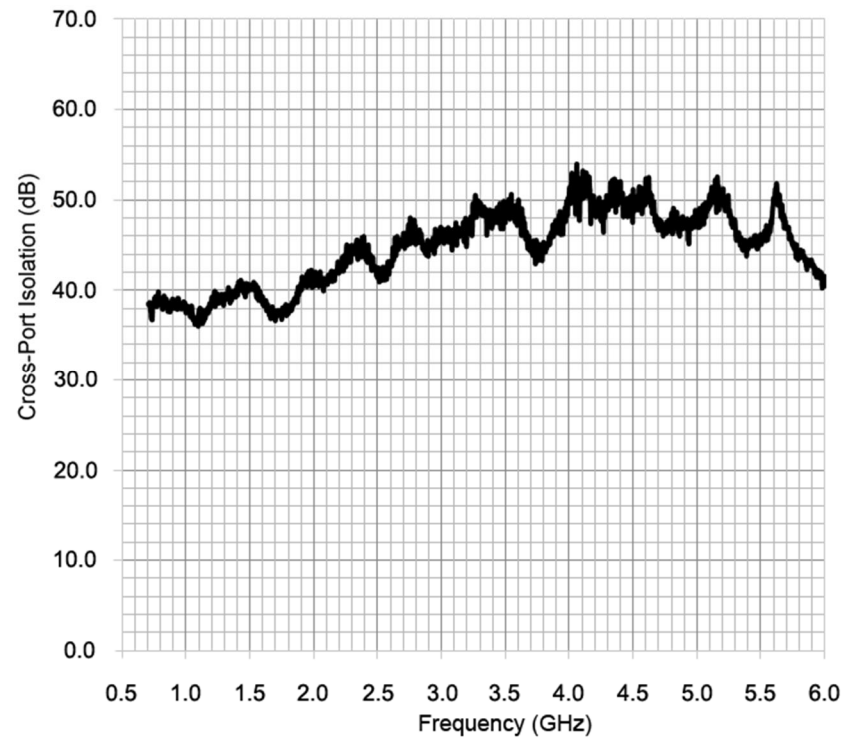

3165-01 Typical Reflectivity

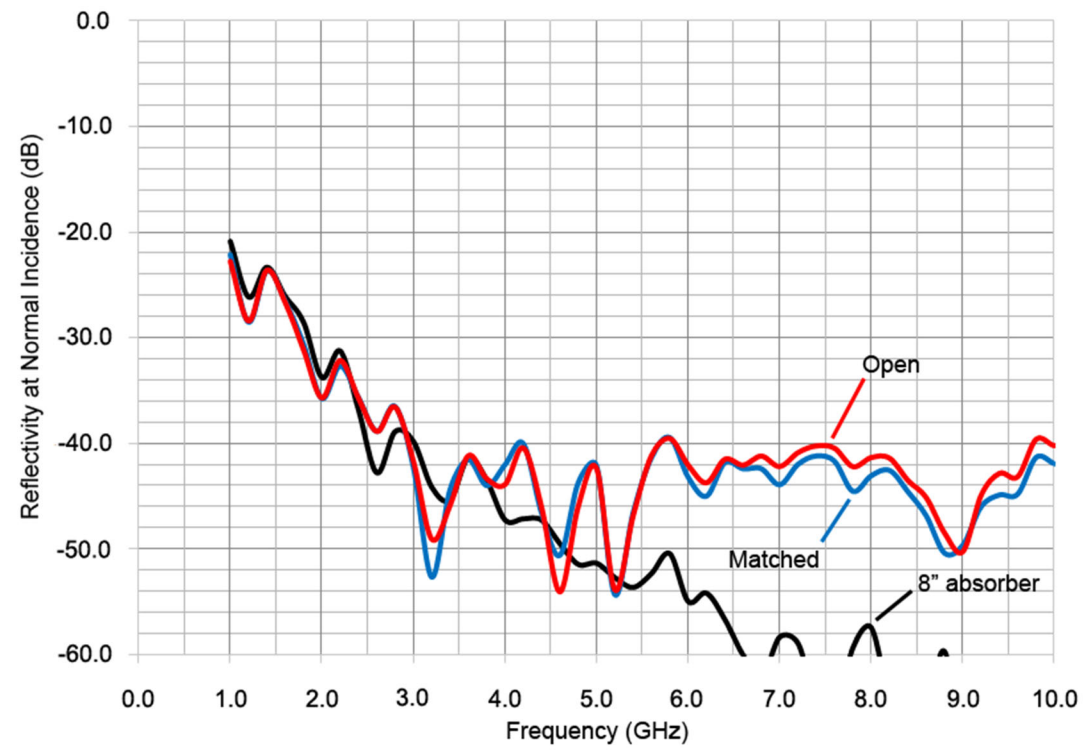

3165-01 Typical E-Plane

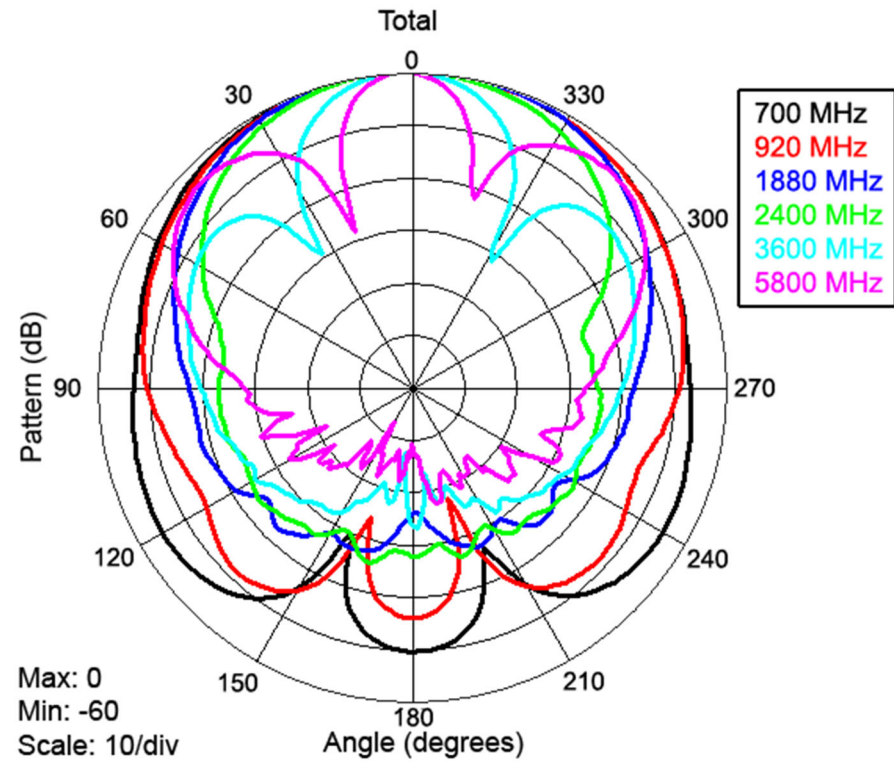

3165-01 Typical H-Plane

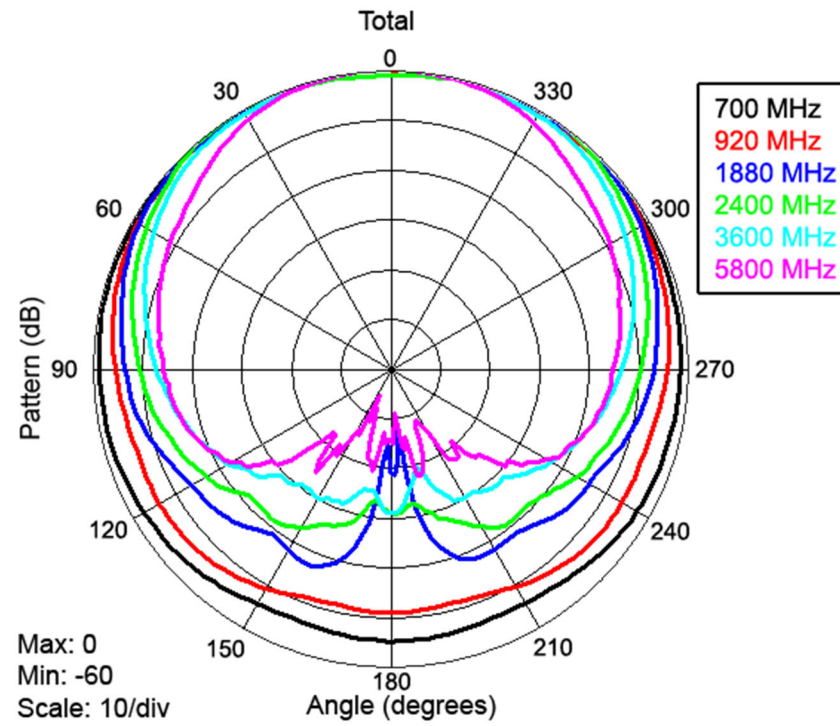

5.0 3165-02 Typical Data

3165-02 Typical Gain

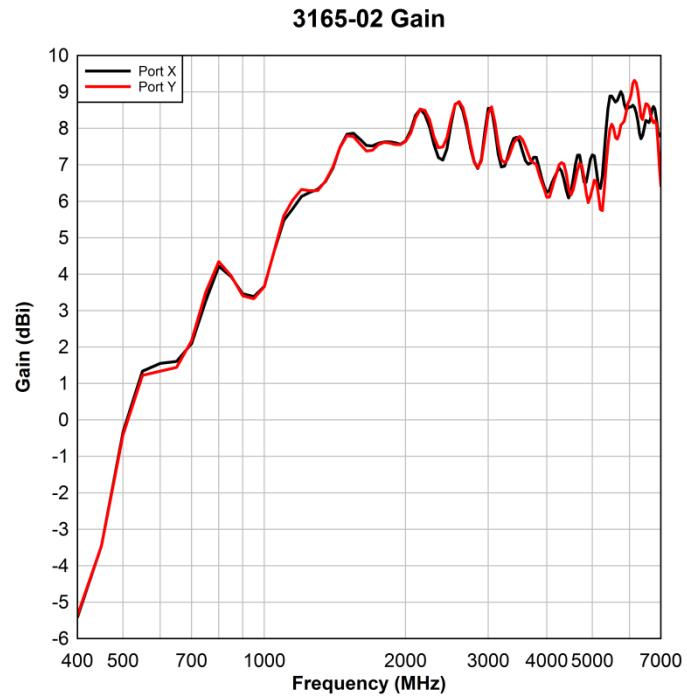

3165-02 Typical VSWR

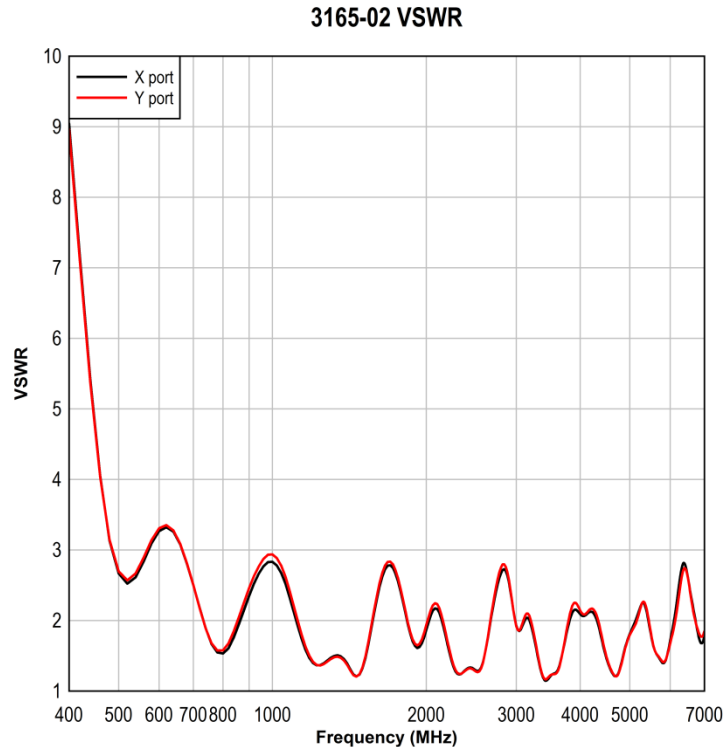

3165-02 Typical Cross-Port Isolation

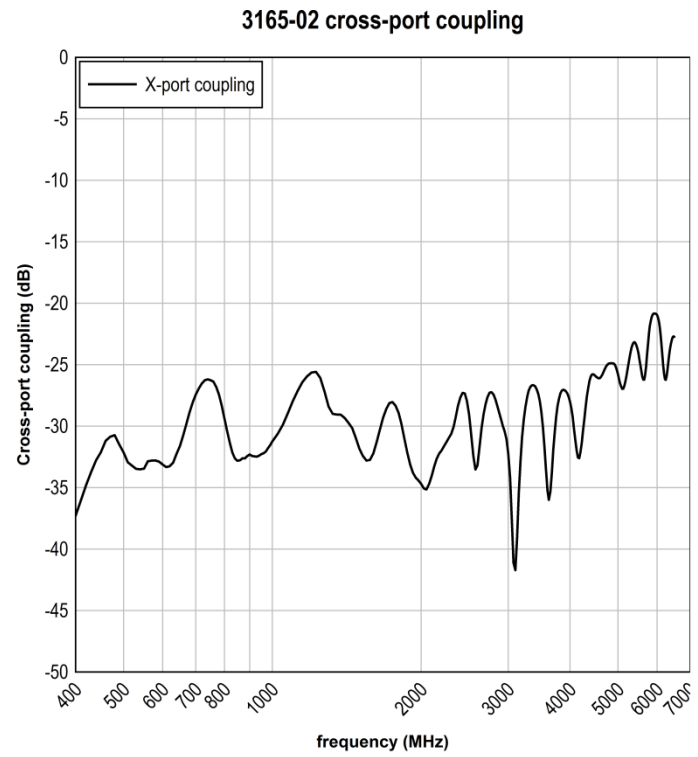

3165-02 Typical Radiation Patterns

3165-02 AT 400 MHz AND 500MHz

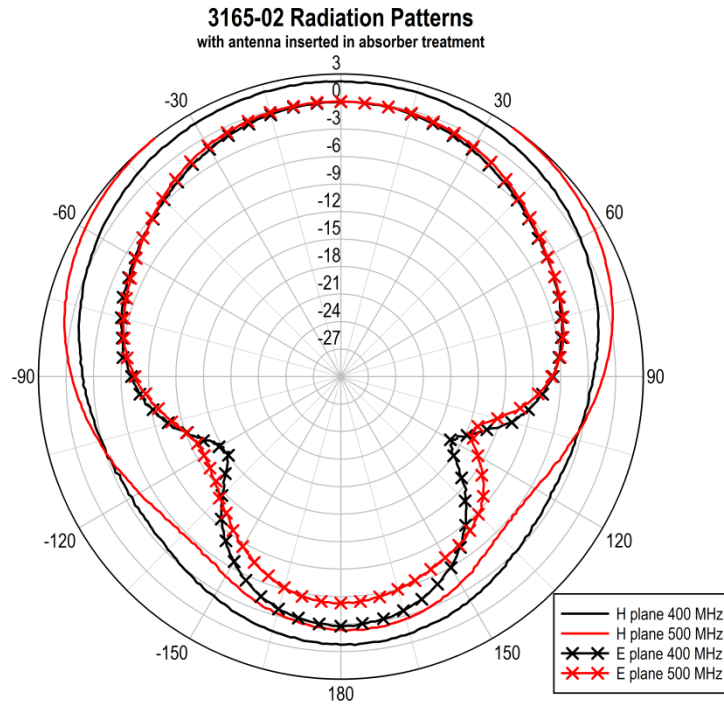

3165-02 AT 600 MHZ AND 700 MHZ

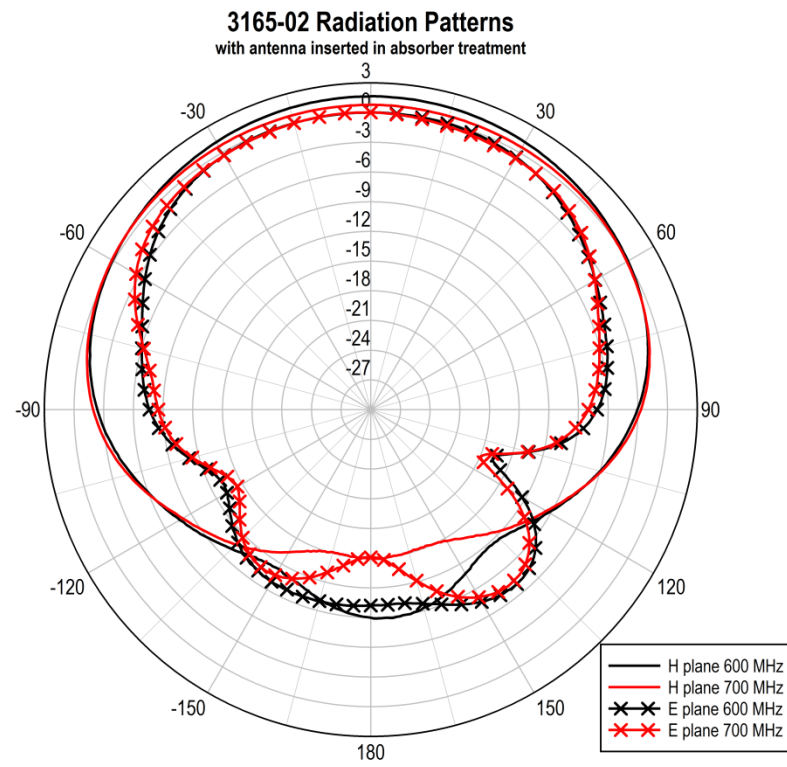

3165-02 AT 800 MHz AND 900 MHz

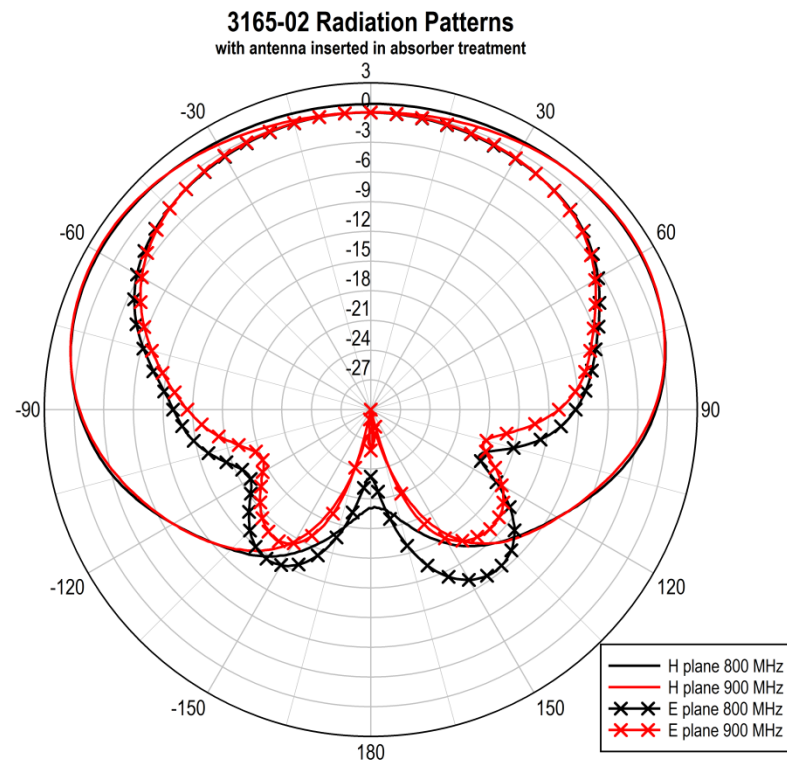

3165-02 AT 1000 MHZ AND 1250 MHZ

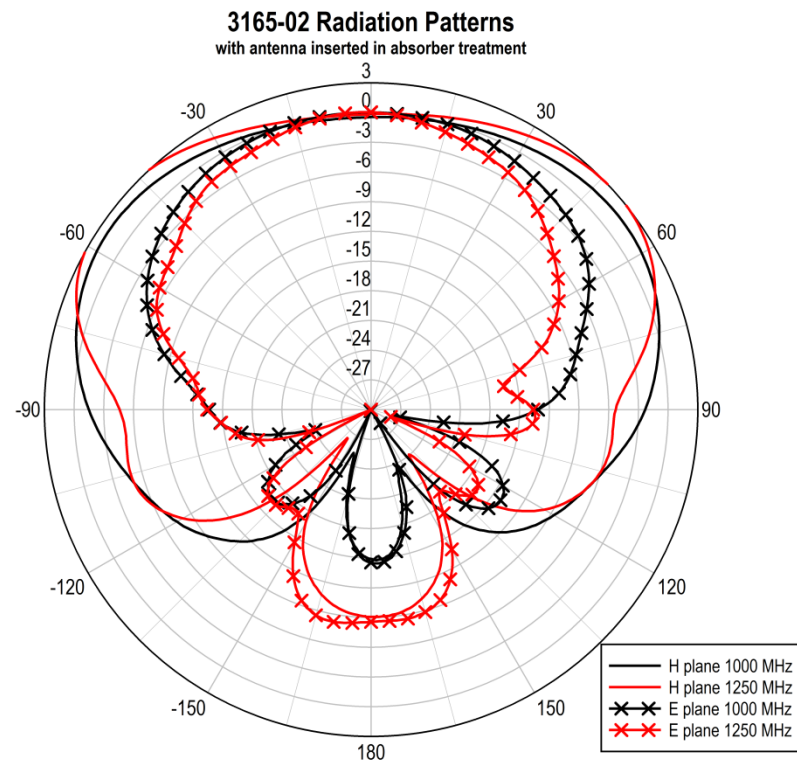

3165-02 AT 1500 MHZ AND 1750 MHZ

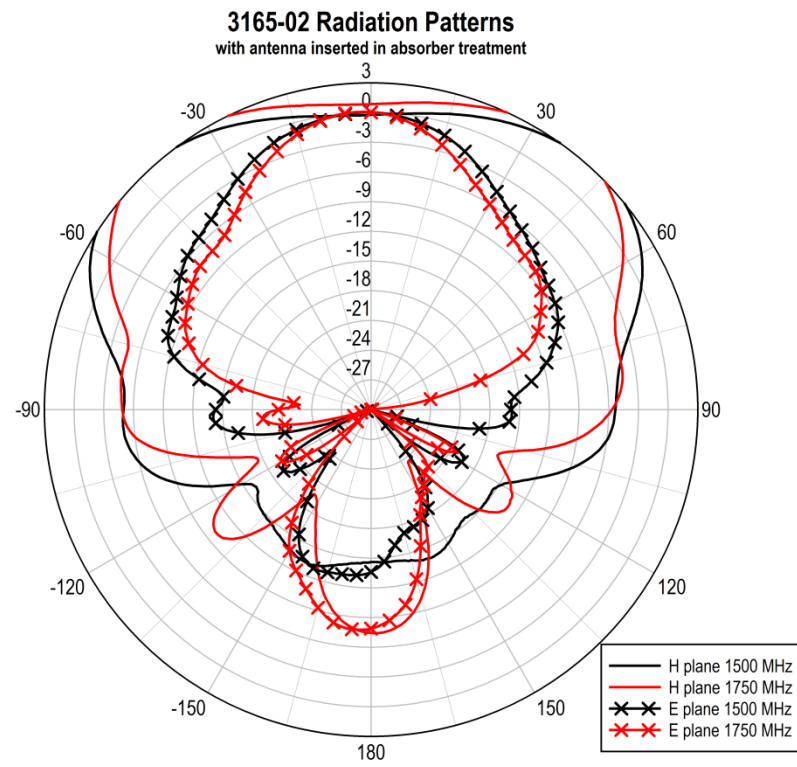

3165-02 AT 2000 MHZ AND 2500 MHZ

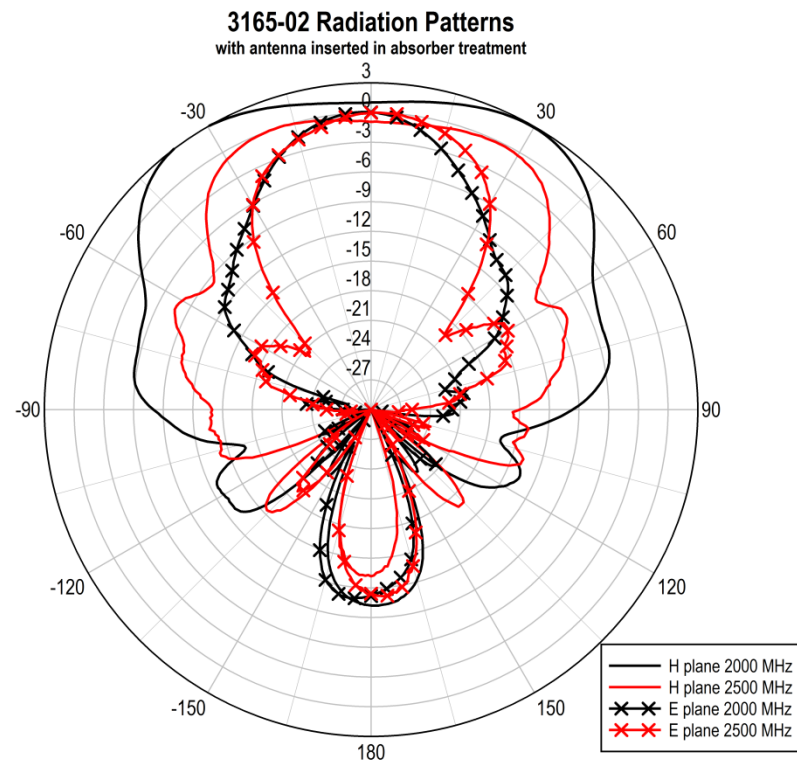

3165-02 AT 3000 MHZ AND 3500 MHZ

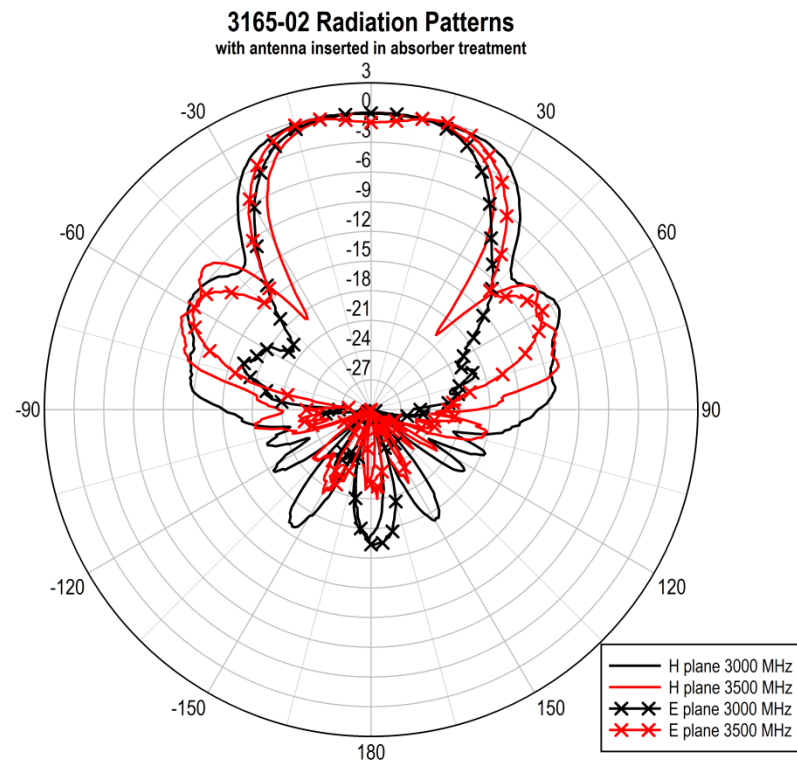

3165-02 AT 4000 MHZ AND 4500 MHZ

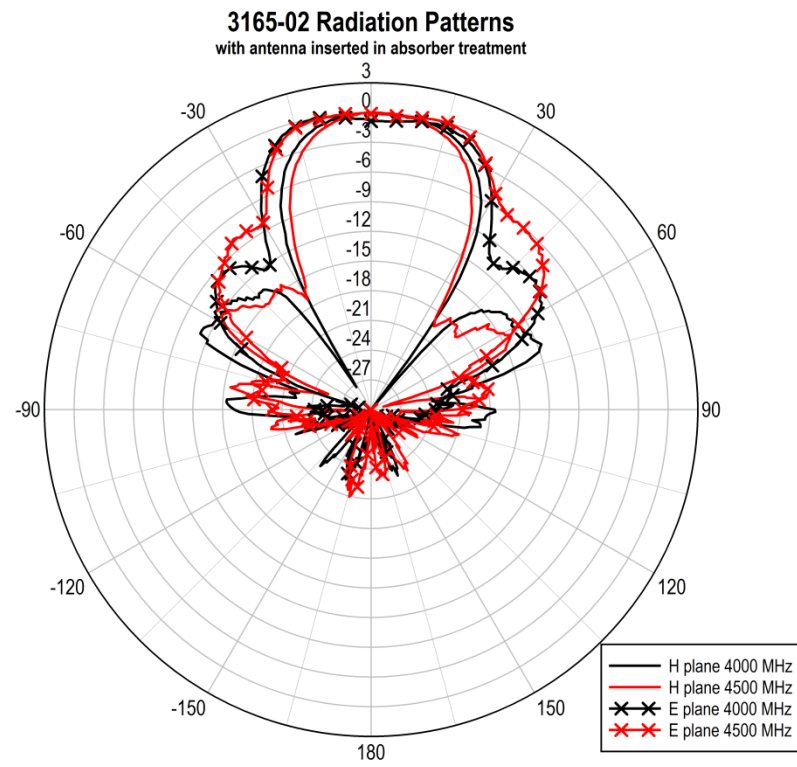

3165-02 AT 5000 MHZ AND 6000 MHZ

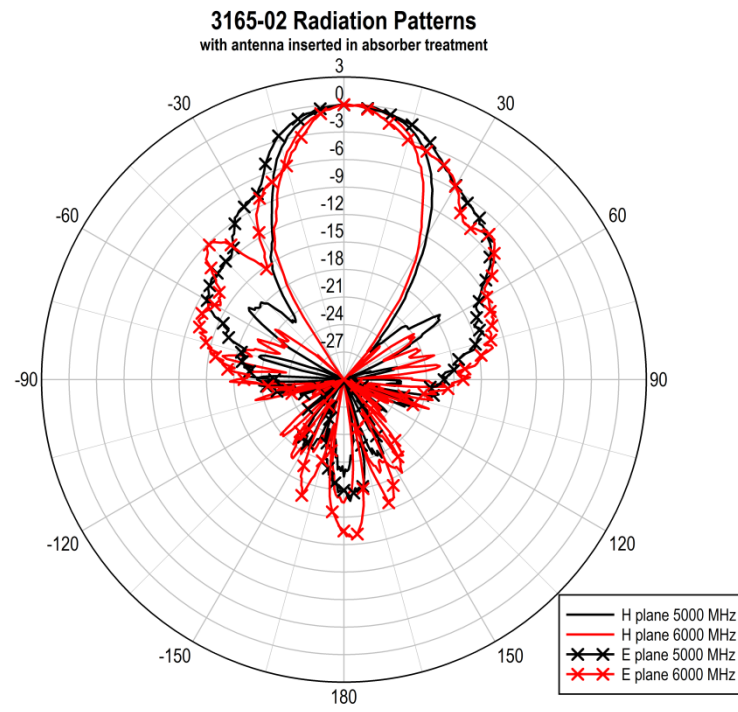

6.0 3165-04 Typical Data

3165-04 Typical Gain

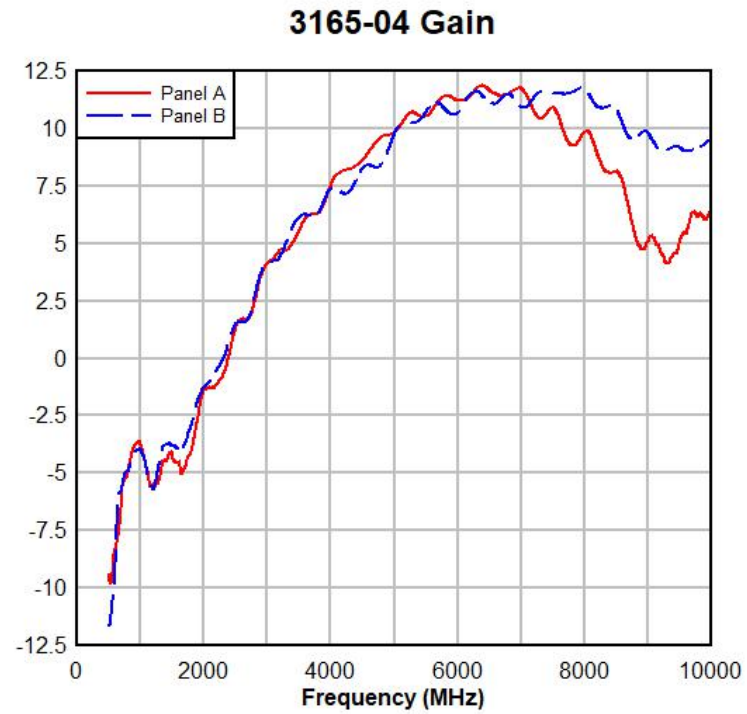

3165-04 Typical VSWR

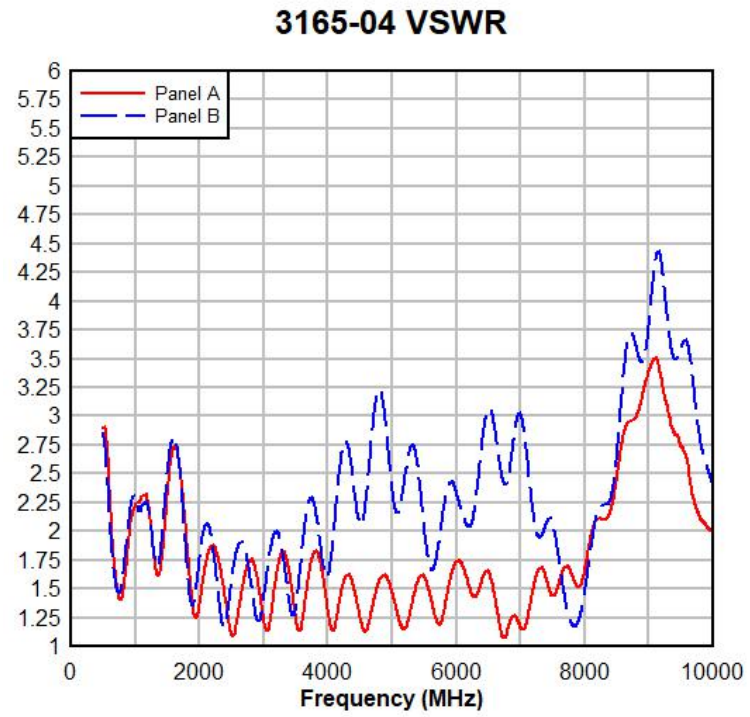

3165-04 Cross Pol

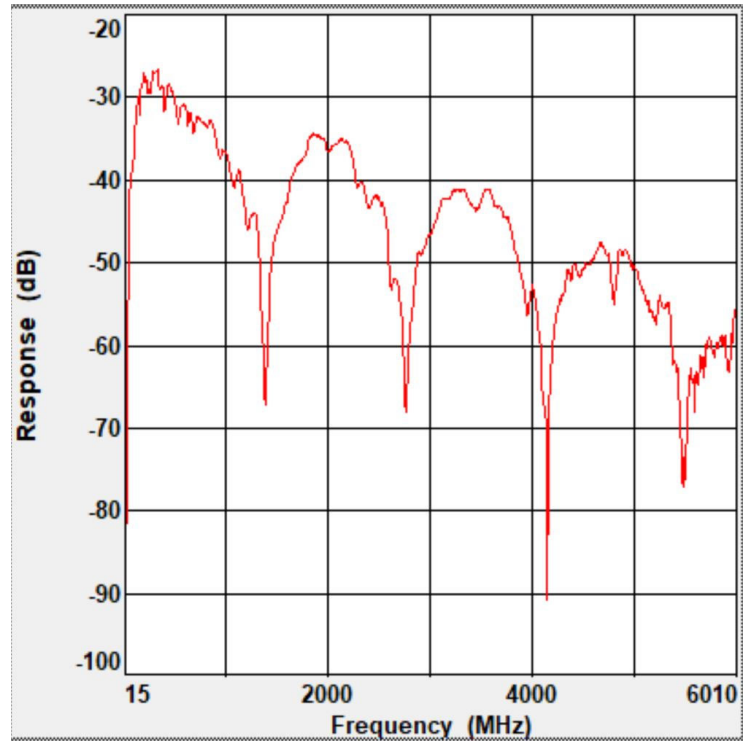

3165-04 Typical Radiation Patterns

3165-04 AT 600 MHz AND 1000MHz

3165-04 Radiation Patterns

with antenna inserted in absorber treatment

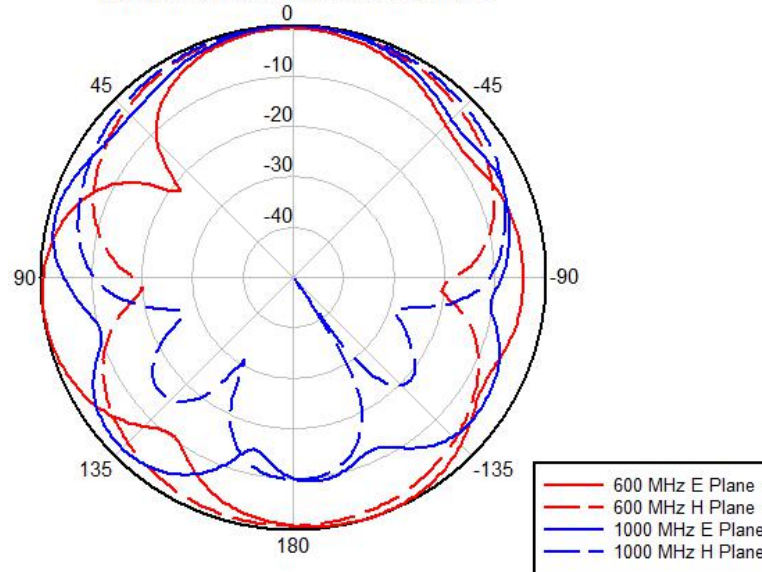

3165-04 AT 1500 MHZ AND 2000MHZ

3165-04 Radiation Patterns

with antenna inserted in absorber treatment

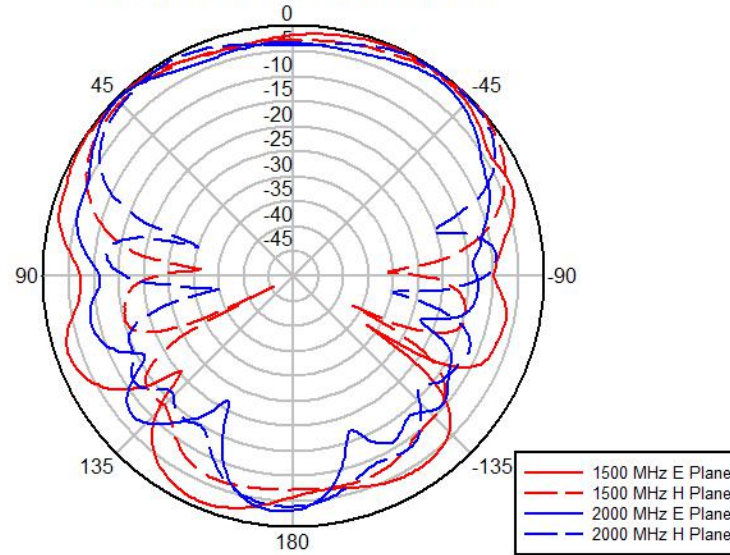

3165-04 AT 2500 MHZ AND 3000MHZ

3165-04 Radiation Patterns

with antenna inserted in absorber treatment

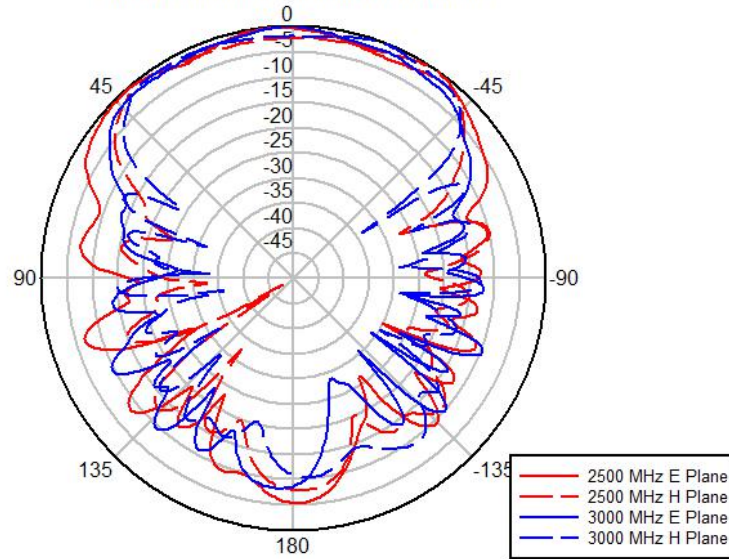

3165-04 AT 3500 MHZ AND 4000MHZ

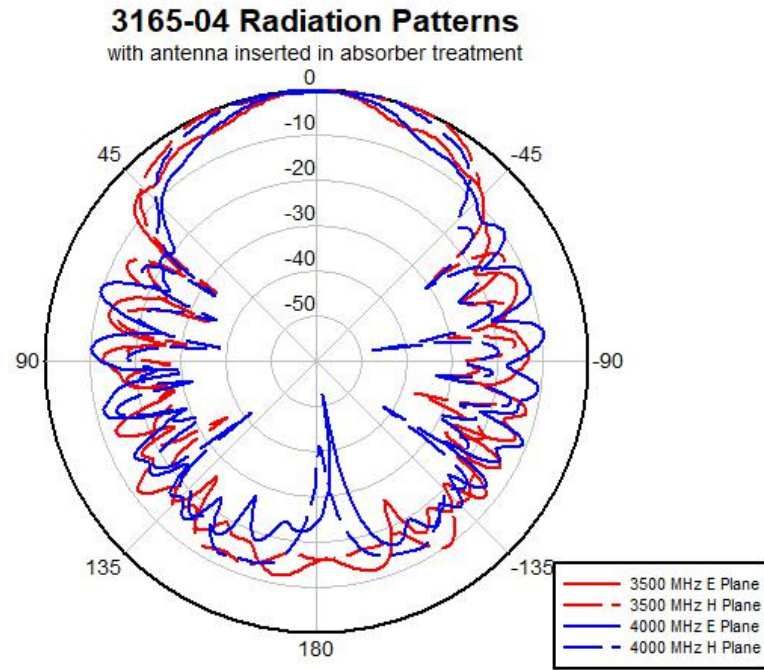

3165-04 AT 4500 MHZ AND 5000MHZ

3165-04 Radiation Patterns

with antenna inserted in absorber treatment

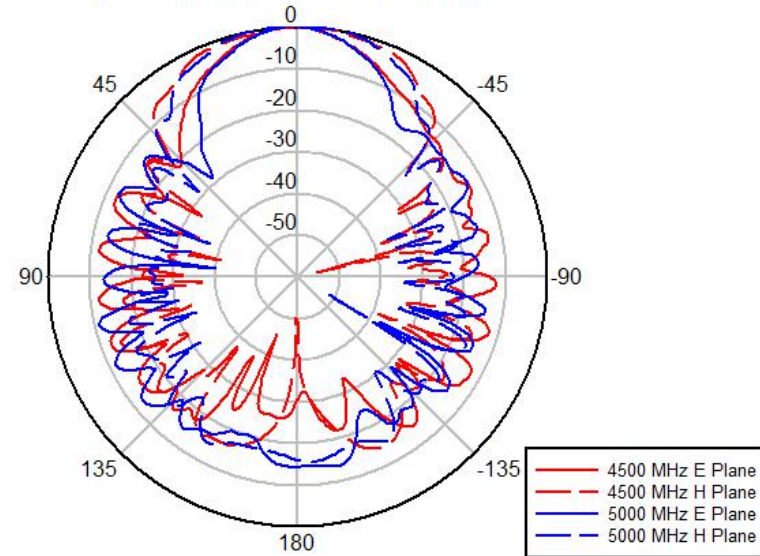

3165-04 AT 5500 MHZ AND 6000MHZ

3165-04 Radiation Patterns

with antenna inserted in absorber treatment

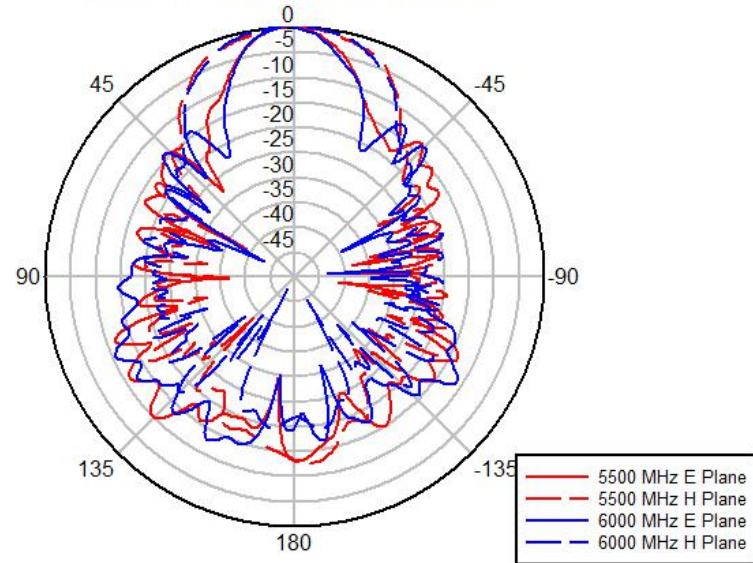

3165-04 AT 6500 MHZ AND 7000MHZ

3165-04 Radiation Patterns

with antenna inserted in absorber treatment

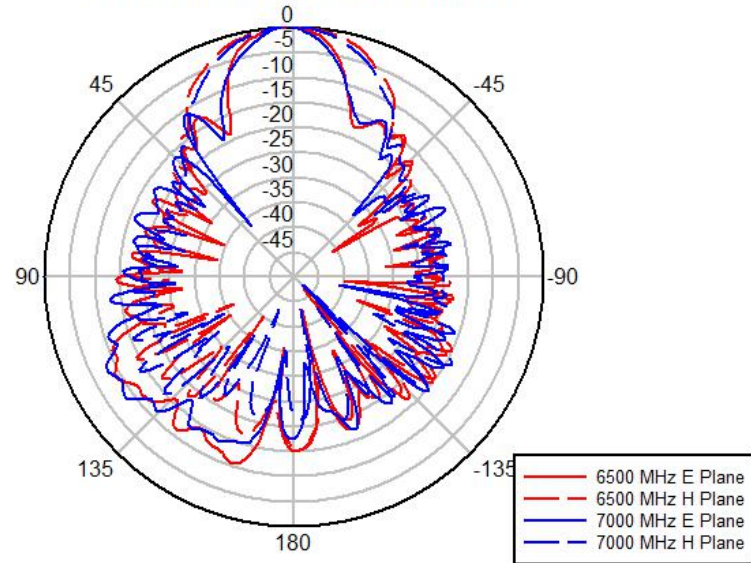

3165-04 AT 7500 MHZ AND 8000MHZ

3165-04 Radiation Patterns

with antenna inserted in absorber treatment

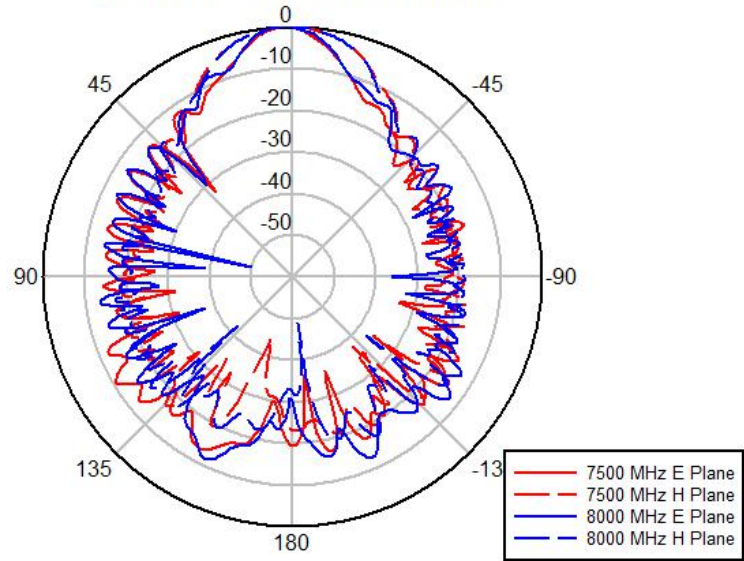

3165-04 AT 8500 MHZ AND 9000MHZ

3165-04 Radiation Patterns

with antenna inserted in absorber treatment

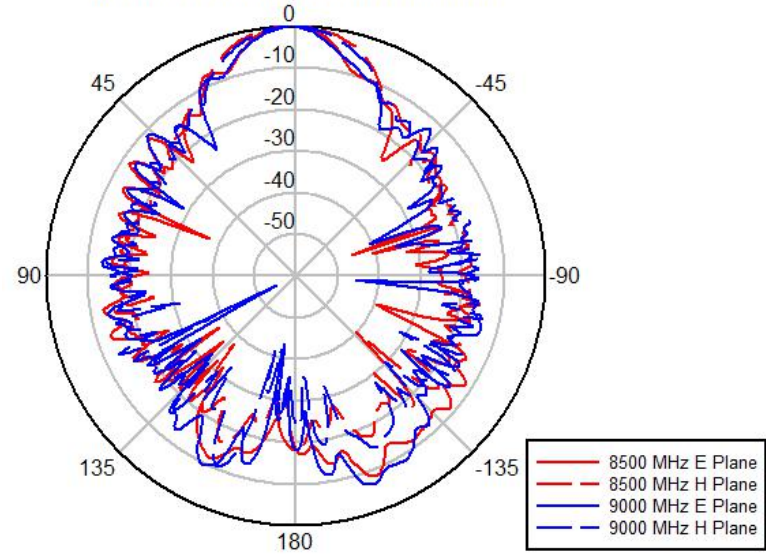

3165-04 AT 9500 MHZ AND 10000MHZ

3165-04 Radiation Patterns

with antenna inserted in absorber treatment

