

*Model 3158*

# High Power Biconical Antenna

User Manual



*Model 3158 shown with optional pedestal Model 113870 (sold separately)*

 **ETS-LINDGREN**<sup>®</sup>  
An ESCO Technologies Company

ETS-Lindgren Inc. reserves the right to make changes to any products herein to improve functioning or design. Although the information in this document has been carefully reviewed and is believed to be reliable, ETS-Lindgren does not assume any liability arising out of the application or use of any product or circuit described herein; nor does it convey any license under its patent rights nor the rights of others. All trademarks are the property of their respective owners.

© Copyright 2000–2021 by ETS-Lindgren Inc. All Rights Reserved. No part of this document may be copied by any means without written permission from ETS-Lindgren Inc.

Trademarks used in this document: The *ETS-Lindgren* logo and *FACT* are trademarks of ETS-Lindgren Inc.

**Revision Record**  
**MANUAL, MODEL 3158 HIGH POWER BICON | Part #399262, Rev. G**

<b>Revision</b>	<b>Description</b>	<b>Date</b>
A	Initial Release	December, 2000
B	Updates / edits	March, 2002
C	Updated <i>Assembly and Mounting Instructions</i> ; Rebrand	February, 2009
D	Updated data; updated photos	May, 2009
E	Updated pedestal information	March, 2016
F	Added weight to specifications	August, 2016
G	Corrected list of supplied items	June, 2021

# Table of Contents

<b>Notes, Cautions, and Warnings</b> .....	<b>v</b>
<b>Safety Information</b> .....	<b>v</b>
<b>1.0 Introduction</b> .....	<b>7</b>
ETS-Lindgren Product Information Bulletin .....	8
<b>2.0 Maintenance</b> .....	<b>9</b>
Annual Calibration .....	9
Maintenance of Fiber Optics .....	9
Service Procedures .....	10
<b>3.0 Specifications</b> .....	<b>11</b>
Electrical Specifications .....	11
Physical Specifications – Antenna Only .....	11
Physical Specifications – Pedestal (sold separately).....	11
<b>4.0 Assembly and Mounting Instructions</b> .....	<b>13</b>
<b>5.0 Typical Data</b> .....	<b>17</b>
Data from MIL-STD-461F/RTCA DO-160 Setup (No Bench) .....	17
MIL-STD-461F/RTCA DO-160 Setup (No Bench).....	18
Data from ISO 11451-2 Setup .....	19
ISO 11451-2 Setup .....	20
Data from ECE Regulation 10 Setup .....	21

This page intentionally left blank.

## Notes, Cautions, and Warnings

---



**Note:** Denotes helpful information intended to provide tips for better use of the product.



**Caution:** Denotes a hazard. Failure to follow instructions could result in minor personal injury and/or property damage. Included text gives proper procedures.



**Warning:** Denotes a hazard. Failure to follow instructions could result in **SEVERE** personal injury and/or property damage. Included text gives proper procedures.



See the ETS-Lindgren *Product Information Bulletin* for safety, regulatory, and other product marking information.

## Safety Information

---



**Refer to Manual:** When product is marked with this symbol, see the instruction manual for additional information. If the instruction manual has been misplaced, download it from [www.ets-lindgren.com](http://www.ets-lindgren.com), or contact ETS-Lindgren Customer Service.



**High Voltage:** Indicates presence of hazardous voltage. Unsafe practice could result in severe personal injury or death.

This page intentionally left blank.

## 1.0 Introduction

---

The **ETS-Lindgren Model 3158 High Field Biconical Antenna** is specifically designed for Immunity testing.

This linearly-polarized transmit antenna is optimized to generate high levels of electromagnetic fields in the range of 20 MHz to 120 MHz.



*Model 3158  
shown with optional pedestal  
Model 113870 (sold separately)*

The ability of the Model 3158 to handle high power levels over a broadband makes it excellent for use in Radiated Susceptibility testing.

The biconical elements are made from welded aluminum tubing. The 4-to-1 ratio balun network is fabricated from G10 fiberglass and specially machined brass and aluminum support and contact parts. The bifilar inductors of the balun are wound in precision-machined cuts to provide high barrier insulation between windings while simultaneously giving good coupling between bifilar windings.

During manufacturing each Model 3158 is individually calibrated using the three antenna method of calibration. The results of the calibration are tabulated and included with the antenna.

## **ETS-Lindgren Product Information Bulletin**

---

See the ETS-Lindgren *Product Information Bulletin* included with your shipment for the following:

- Safety, regulatory, and other product marking information
- Steps to receive your shipment
- Steps to return a component for service
- ETS-Lindgren calibration service
- ETS-Lindgren contact information



## 2.0 Maintenance

---



Before performing any maintenance, follow the safety information in the ETS-Lindgren *Product Information Bulletin* included with your shipment.



Maintenance of the Model 3158 is limited to external components such as cables or connectors.

If you have any questions concerning maintenance, contact ETS-Lindgren Customer Service.

### Annual Calibration

---

See the *Product Information Bulletin* included with your shipment for information on ETS-Lindgren calibration services.

### Maintenance of Fiber Optics

---

Fiber optic connectors and cables can be damaged from airborne particles, humidity and moisture, oils from the human body, and debris from the connectors they plug into. Always handle connectors and cables with care, using the following guidelines.



**Before performing any maintenance, disconnect the fiber optic cables from the unit and turn off power.**

**When disconnecting fiber optic cables, apply dust caps to the ends to maintain their integrity.**

**Before connecting fiber optic cables, clean the connector tips.**

**Before attaching connectors, clean them with moisture-free compressed air.**

**Failure to perform these tasks may result in damage to the fiber optic connectors or cables.**

## **Service Procedures**

---

For the steps to return a system or system component to ETS-Lindgren for service, see the *Product Information Bulletin* included with your shipment.

### 3.0 Specifications

---

#### Electrical Specifications

---

Frequency Range:	20 MHz to 120 MHz
VSWR Ratio:	<ul style="list-style-type: none"><li>• Typical—2:1</li><li>• Maximum—5:1</li></ul>
Maximum Input Power:	5 kW
Input Impedance:	50 $\Omega$
Connector:	7/16 DIN female

#### Physical Specifications – Antenna Only

---

Length:	1.14 m (3.74 ft)
Width:	3.00 m (9.84 ft)
Height:	1.14 m (3.74 ft)
Weight:	16.33 kg (36 lbs)

#### Physical Specifications – Pedestal (sold separately)

---

Length:	1.73 m (5.68 ft)
Width:	1.52 m (5.00 ft)
Height:	2.51 m (8.23 ft)
Tilt Range:	0° to 45°

This page intentionally left blank.

## 4.0 Assembly and Mounting Instructions



Before connecting any components, follow the safety information in the ETS-Lindgren *Product Information Bulletin* included with your shipment.

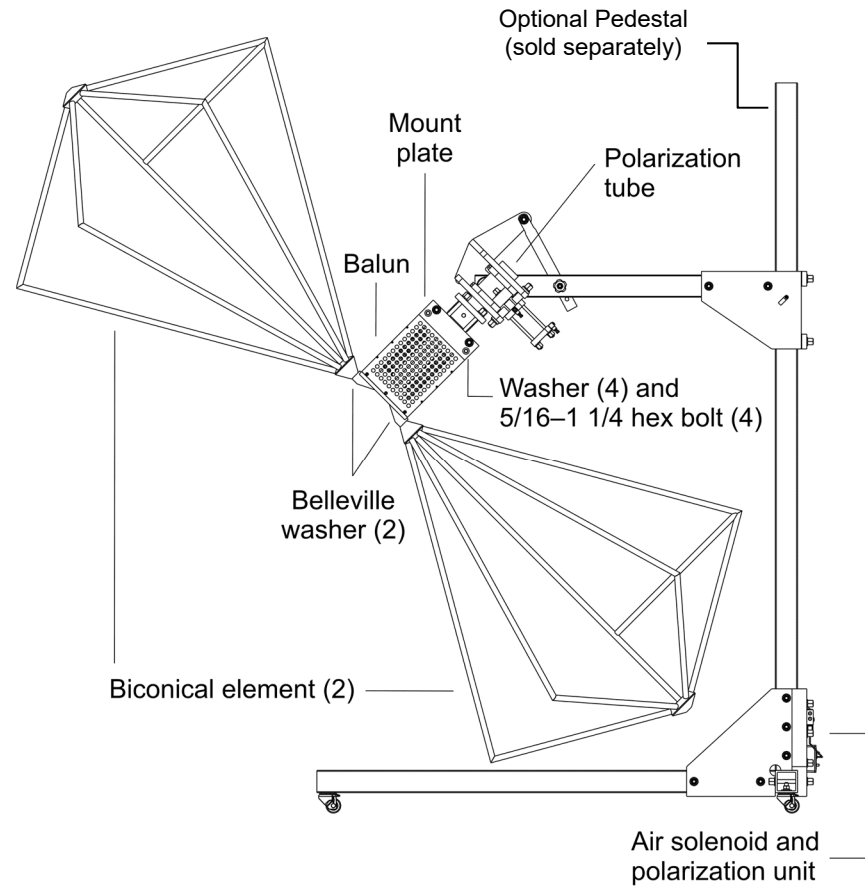

Illustration features optional components (sold separately).

The Model 3158 High Power Biconical Antenna is shipped unassembled, and includes these parts:

- Balun
- Biconical element (2)
- Belleville washer (2)



An optional pedestal, Model 113870, is sold separately



Due to the size of the antenna, you must mount the balun onto the pedestal before you attach the elements.

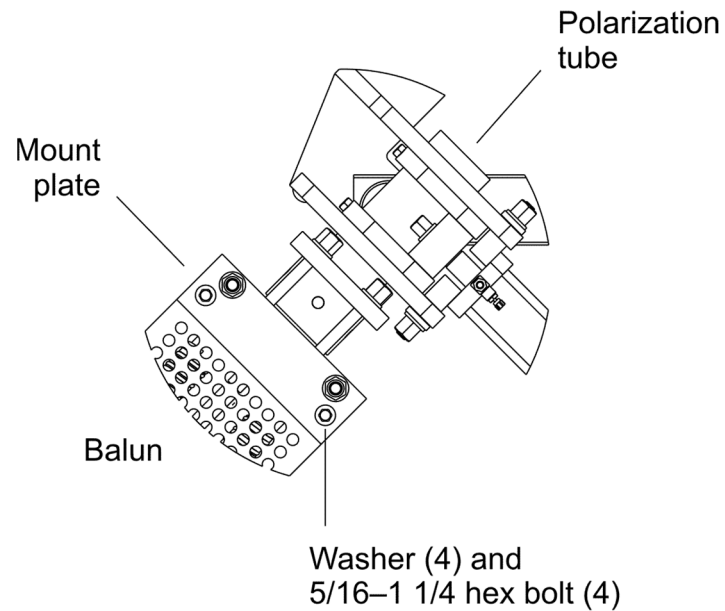

1. Run your antenna cable through the polarization tube and attach it to the connector on the bottom of the balun.



Illustration features optional components (sold separately).

2. Place the bottom of the balun in the mount plate. Insert two washers and two hex bolts on both sides of the mount plate to firmly secure the balun in place.



**Do not cross thread any connections or permanent damage could occur.**

3. Slide a belleville washer onto the threaded screw end of one of the biconical elements.
4. Line up the screw threads on the element with the receptacle hole on the balun and turn the element until it is firmly secured in the balun.
5. Repeat step 3 and step 4 for the remaining biconical element.



**Damage to the pneumatic system may occur if the air supply exceeds the maximum 50 psi–70 psi.**

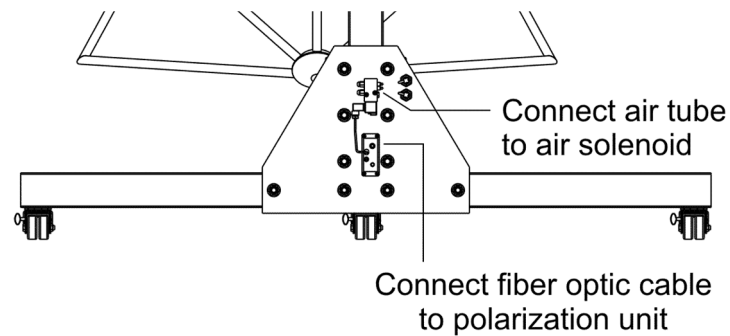

6. Connect the air solenoid tube to the air solenoid located on the back of the pedestal. Connect the other end to your air supply.



The Model 2090 (or next generation ETS-Lindgren controller, if applicable) is a separate component required for operation.

7. Connect the fiber optic polarization cable to the polarization unit located on the back of the pedestal. Connect the other end to the Model 2090 Multi-Device Controller.





## 5.0 Typical Data



All data was measured in an ETS-Lindgren FACT™ 3 chamber; field for a 5-kW input.

### Data from MIL-STD-461F/RTCA DO-160 Setup (No Bench)

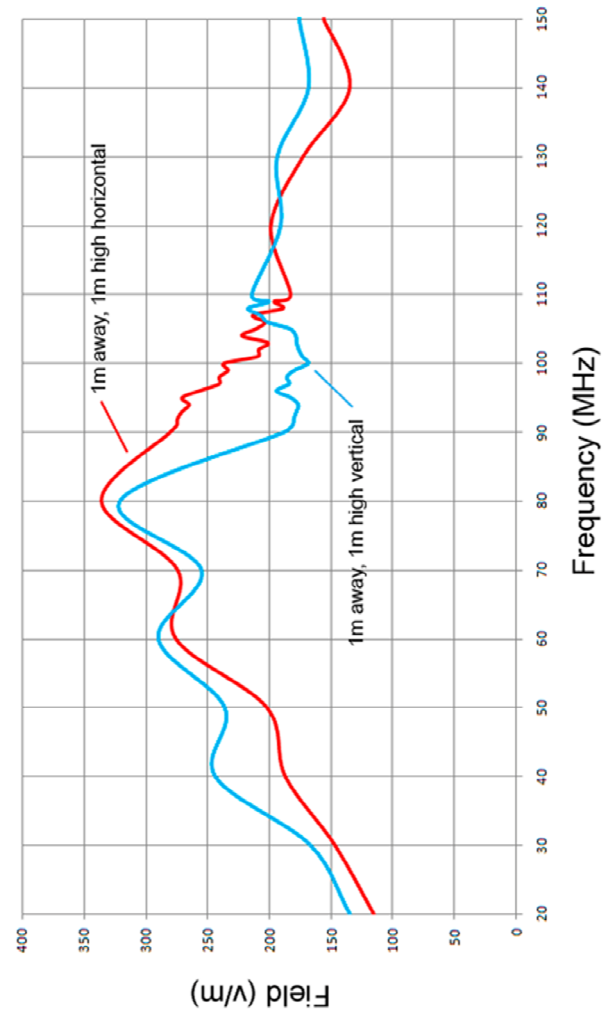

## MIL-STD-461F/RTCA DO-160 SETUP (NO BENCH)

Shown with optional pedestal Model 113870 (sold separately).

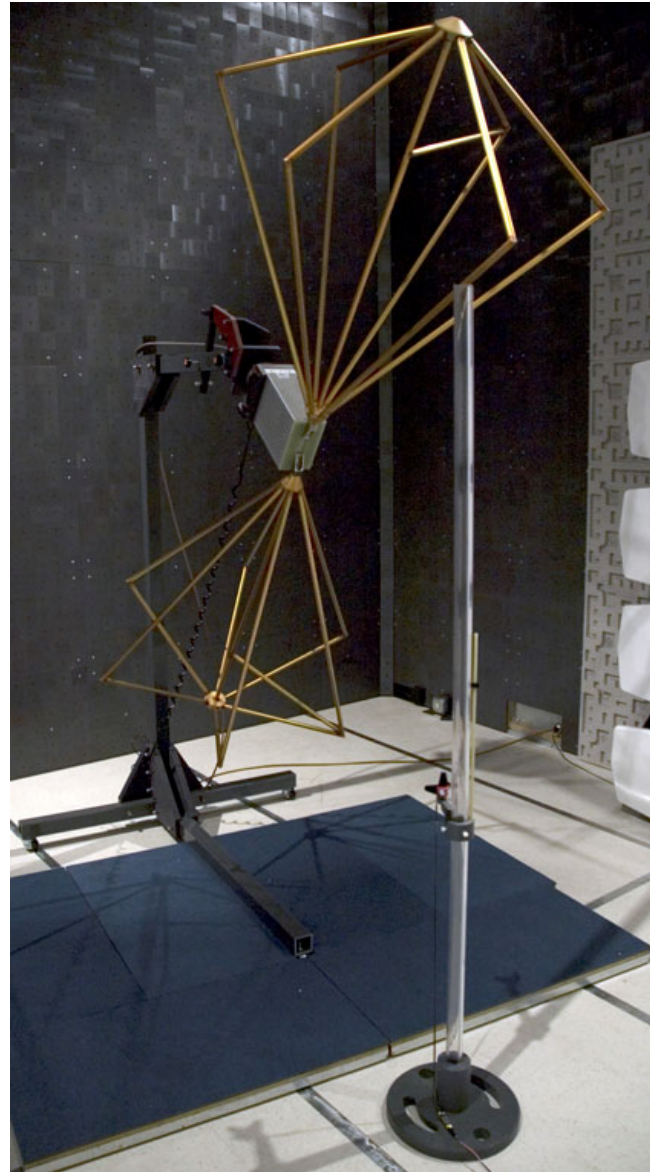

Data from ISO 11451-2 Setup

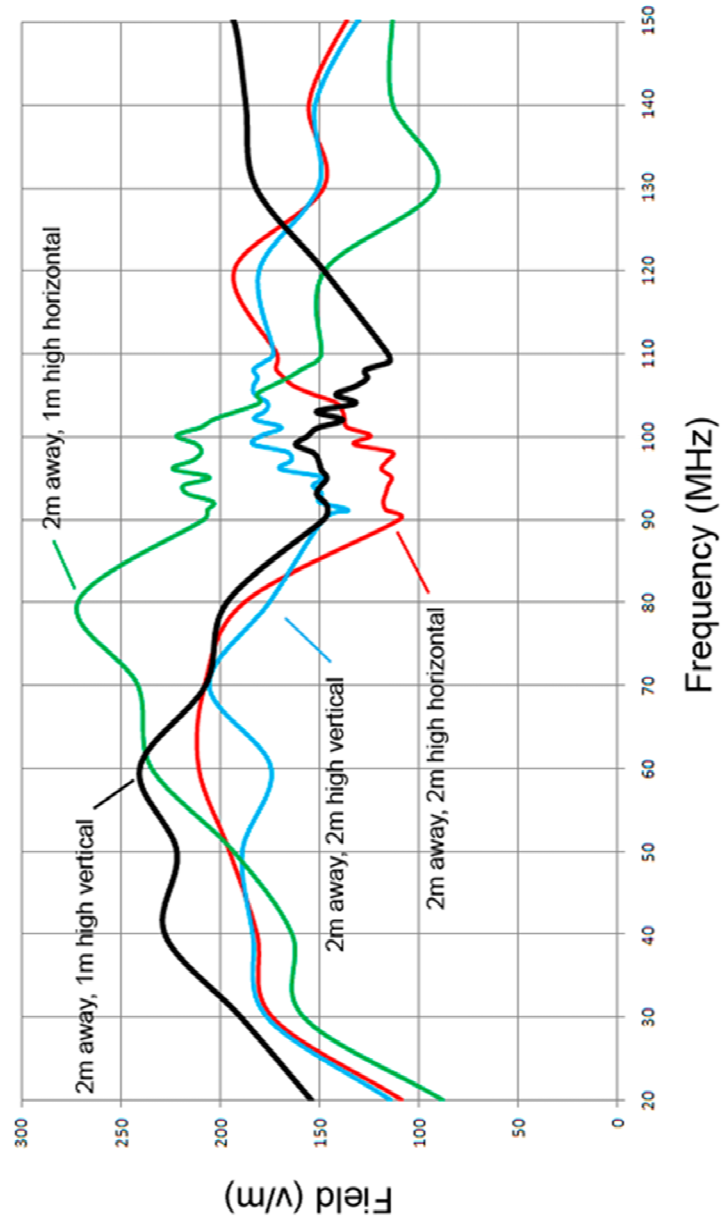

## ISO 11451-2 SETUP

Shown with optional pedestal Model 113870 (sold separately).

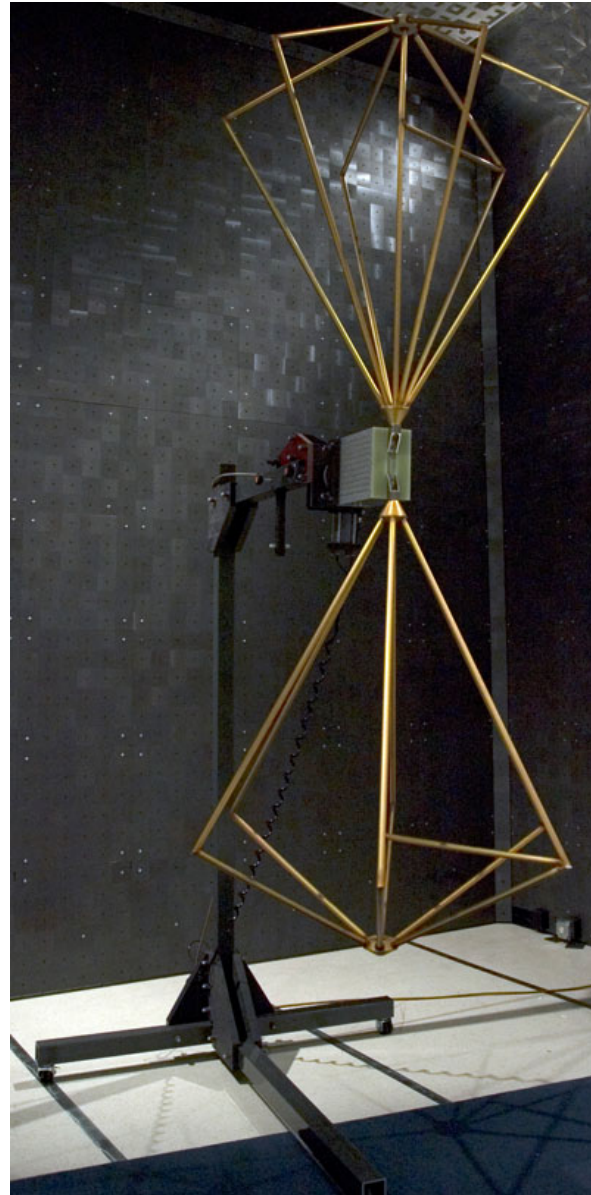

## Data from ECE Regulation 10 Setup



Power input for 30V/m at 2 meters from the antenna and 1 meter over the ground.

