

3119B Double-Ridged Waveguide Horn Antenna

User Manual

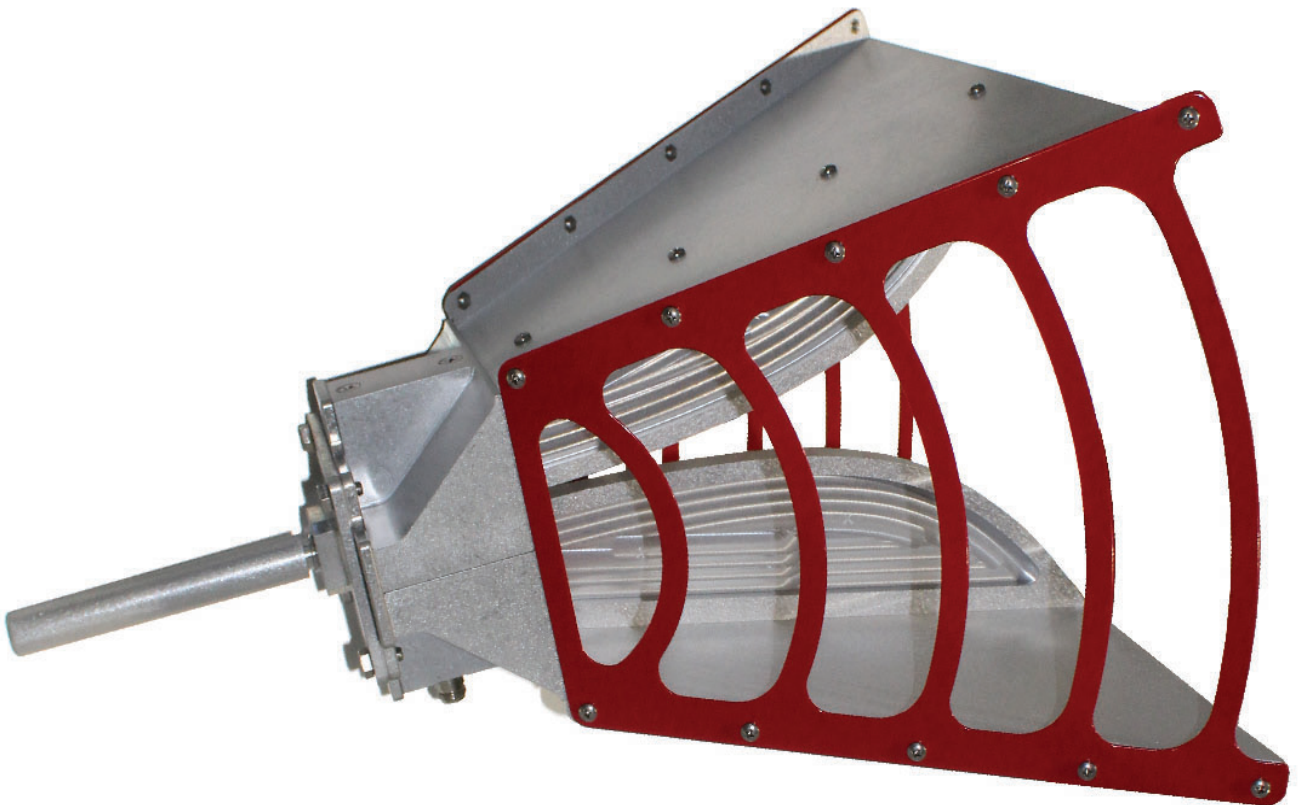

ETS-Lindgren Inc. reserves the right to make changes to any products herein to improve functioning or design. Although the information in this document has been carefully reviewed and is believed to be reliable, ETS-Lindgren does not assume any liability arising out of the application or use of any product or circuit described herein; nor does it convey any license under its patent rights nor the rights of others. All trademarks are the property of their respective owners.

© Copyright 2018-2021 by ETS-Lindgren Inc. All Rights Reserved. No part of this document may be copied by any means without written permission from ETS-Lindgren Inc.

Trademarks used in this document: The ETS-Lindgren logo is a registered trademark of ETS-Lindgren, Inc.

Revision Record
MANUAL, 3119B | Part # 1682076 Rev B

Revision	Description	Date
A	Initial Release	SEPTEMBER, 2018
B	Corrected weight	MARCH, 2021





TABLE OF CONTENTS

NOTES, CAUTIONS AND WARNINGS	7
SAFETY INFORMATION	7
GENERAL SAFETY CONSIDERATIONS	8
INTRODUCTION	9
Optional Items (Sold Separately)	10
7-TR Tripod.	10
7-TR Boom Options	10
ETS-Lindgren Product Information Bulletin	11
MAINTENANCE	12
Annual Calibration	12
Replacement and Optional Parts	12
SPECIFICATIONS	13
Electrical Specifications	13
Physical Specifications	13
MOUNTING INSTRUCTIONS	14
2x2 Boom Mounting Options	14
7-TR and Mast Mounting Options	14
Attach Mounting Bracket to Antenna	15
TYPICAL DATA	16
APPENDIX A: Typical Measured Radiated Patterns	19

NOTES, CAUTIONS AND WARNINGS

	<p>Note: Denotes helpful information intended to provide tips for better use of the product.</p>
<p>CAUTION</p>	<p>Caution: Denotes a hazard. Failure to follow instructions could result in minor personal injury and/or property damage. Included text gives proper procedures.</p>
<p>WARNING</p>	<p>Warning: Denotes a hazard. Failure to follow instructions could result in SEVERE personal injury and/or property damage. Included text gives proper procedures.</p>





SAFETY INFORMATION

	<p>Refer to Manual: When product is marked with this symbol, see the instruction manual for additional information. If the instruction manual has been misplaced, download it from www.ets-lindgren.com, or contact ETS Lindgren Customer Service.</p>
	<p>High Voltage: Indicates presence of hazardous voltage. Unsafe practice could result in severe personal injury or death.</p>
	<p>High Voltage: Indicates presence of hazardous voltage. Unsafe practice could result in severe personal injury or death.</p>
	<p>Protective Earth Ground (Safety Ground): Indicates protective earth terminal. You should provide uninterruptible safety earth ground from the main power source to the product input wiring terminals, power cord, or supplied power cord set.</p>



See the ETS-Lindgren *Product Information Bulletin* for safety, regulatory, and other product marking information.

GENERAL SAFETY CONSIDERATIONS

	<p>Before power is applied to this instrument, ground it properly through the protective conductor of the AC power cable to a power source provided with the protective earth contact. Any interruption of the protective (grounding) conductor, inside or outside the instrument, or disconnection of the protective earth terminal could result in personal injury.</p>
 	<p>Before servicing: contact ETS-Lindgren – servicing (or modifying) the unit by yourself may void your warranty. If you attempt to service the unit by yourself, disconnect all electrical power before starting. There are voltages at many points in the instrument which could, if contacted, cause personal injury. Only trained service personnel should perform adjustments and/or service procedures upon this instrument. Capacitors inside this instrument may still be CHARGED even when instrument is disconnected from its power source.</p>
	<p>Only qualified personnel should operate (or service) this equipment.</p>

INTRODUCTION

The Model 3119B Double-Ridged Waveguide Horn is a linearly polarized broadband antenna covering the frequency range of 400 MHz to 6 GHz.

The Model 3119B is ideally suited for immunity over 1 GHz and as a reference antenna for wireless testing. In addition, the 3119B is useful for antenna pattern measurement as a source antenna.

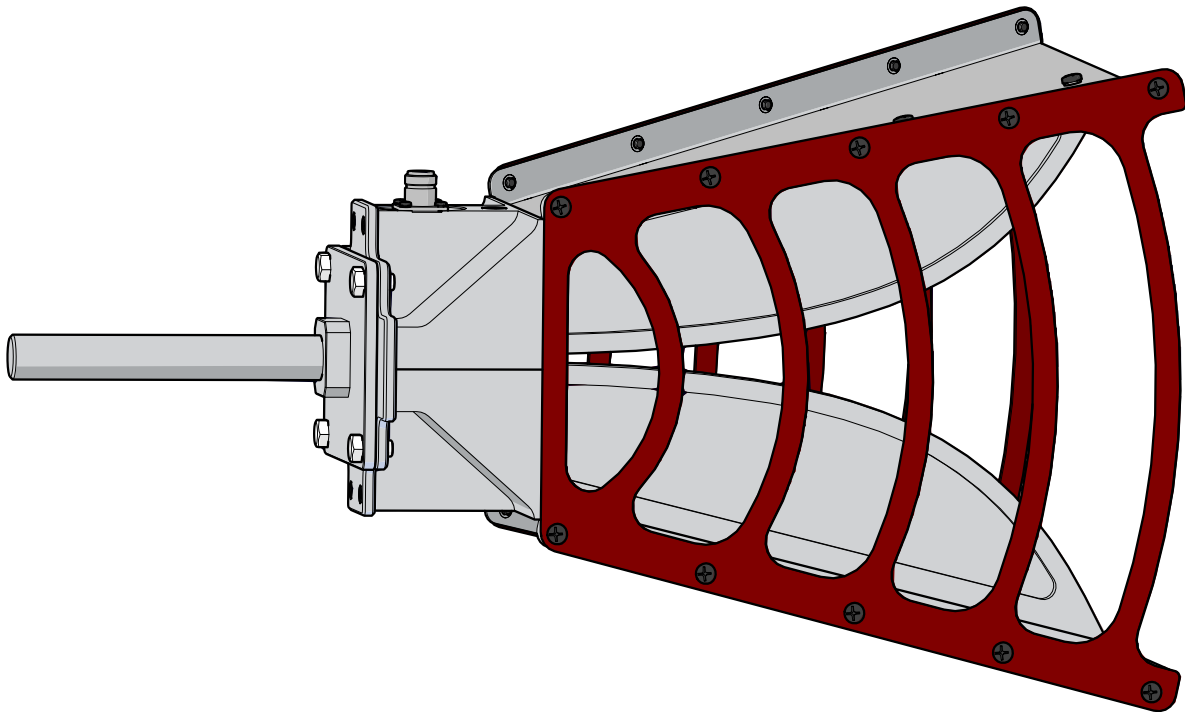

Optional Items (Sold Separately)

7-TR Tripod

7-TR Tripod - Constructed of PVC and fiberglass components, providing increased stability for physically large antennas. The unique design allows for quick assembly, disassembly, and convenient storage. Allows several different configurations, including options for manual or pneumatic polarization. Quick height adjustment and locking wheels provide ease of use during testing.

Maximum Height	2.17 m (85.8 in)
Minimum Height	0.8 m (31.8 in)
Maximum Load	13.5 kg (30 lb)



7-TR with 108983 (includes 118947)



7-TR with 118947

7-TR Boom Options



Boom Type	Function
Straight (109042)	For general antenna mounting on a 7-TR.
Offset (108983)	For general antenna mounting on a 7-TR with pneumatic or manual polarization. Can also be used to mount stinger-type antennas.
Stinger Only (118947)	For stinger mount antennas only.

ETS-Lindgren Product Information Bulletin

See the ETS-Lindgren *Product Information Bulletin* included with your shipment for the following:

- Safety, regulatory, and other product marking information
- Steps to receive your shipment
- Steps to return a component for service
- ETS Lindgren calibration service
- ETS Lindgren contact information

MAINTENANCE

	<p>Before connecting any components or operating the Double-Ridged Waveguide Horn Antennas, follow the safety information in the ETS-Lindgren <i>Product Information Bulletin</i> included with your shipment.</p>
	<p>Maintenance of a Double-Ridged Waveguide Horn Antenna is limited to external components such as cables or connectors.</p>
	<p>If you have any questions concerning maintenance, contact ETS Lindgren Customer Service.</p>

Annual Calibration

See the *Product Information Bulletin* included with your shipment for information on ETS-Lindgren calibration services.

Replacement and Optional Parts

	<p>ETS-Lindgren may substitute a similar part or new part number with the same functionality for another part/part number. Contact ETS-Lindgren for questions about part numbers and ordering parts.</p>
---	--

SPECIFICATIONS

CAUTION

Before placing into operation, follow the safety information in the ETS-Lindgren *Product Information Bulletin* included with your shipment.

Electrical Specifications

Frequency Range	400 MHz—6 GHz
VSWR Ration (Average)	3.5:1
Maximum Continuous Power	- Type N 400 MHz: 1 kW 6 GHz: 250 W - Type 7/16 DIN 400 MHz: 1.5 kW 6 GHz: 400 W
Impedance (Nominal)	50 Ω
Connector	- Type N, female (standard connector) - 7/16 DIN (optional connector; must be specified at time of purchase)
Front-to-Back Ratio	20 dB
Cross Polarization	20 dB minimum

Physical Specifications

Width	48.84 cm (19.23 in)
Depth	40 cm (15.74 in)
Height	31.37 cm (12.35 in)
Approximate Weight	5.2 kg (11.5 lb)

MOUNTING INSTRUCTIONS

CAUTION	Before connecting any components or operating the Double-Ridged Waveguide Horn Antennas, follow the safety information in the ETS-Lindgren <i>Product Information Bulletin</i> included with your shipment.
CAUTION	The Double-Ridged Waveguide Horn Antennas are precision instruments. Handle with care.
	Make sure that no part of the antenna is in contact with the tripod or tower.

2x2 Boom Mounting Options

	2x2 boom refers to a typical 2-inch by 2-inch boom.
---	---

7-TR and Mast Mounting Options

	For a list of 7-TR boom options, see page 9. For 7-TR mounting instructions, see the 7-TR manual.
---	---

Following are options for mounting a Double-Ridged Waveguide Horn Antenna onto a 2x2 boom. Contact the ETS-Lindgren Sales Department for information on ordering optional mounting hardware.

This illustration provides an option for mounting a Double-Ridged Waveguide Horn Antenna onto an ETS-Lindgren 7-TR Tripod or mast. Contact the ETS-Lindgren Sales Department for information on ordering optional mounting hardware.

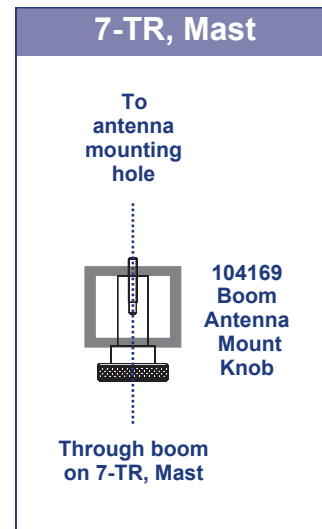
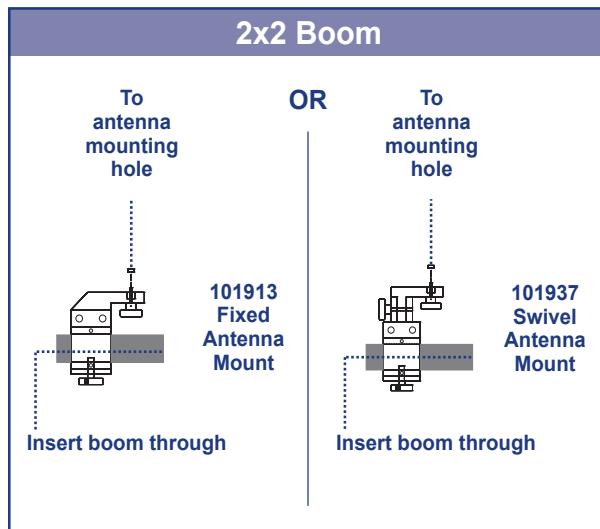

Attach Mounting Bracket to Antenna

The following illustration represents a typical assembly of the stinger mount to the antenna.

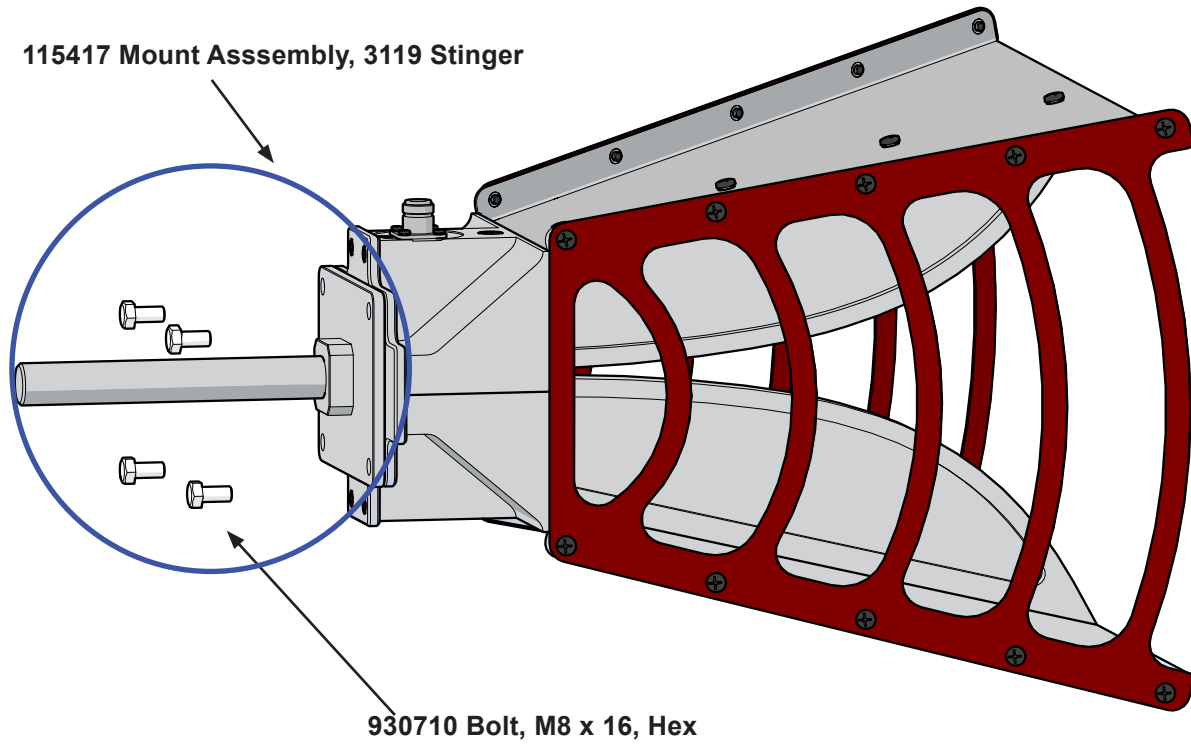

1. Align the holes on the back of the antenna with the ones on the bracket provided.
2. Select set of holes for horizontal or vertical polarization as desired.
3. Tighten hex metric bolts.

TYPICAL DATA

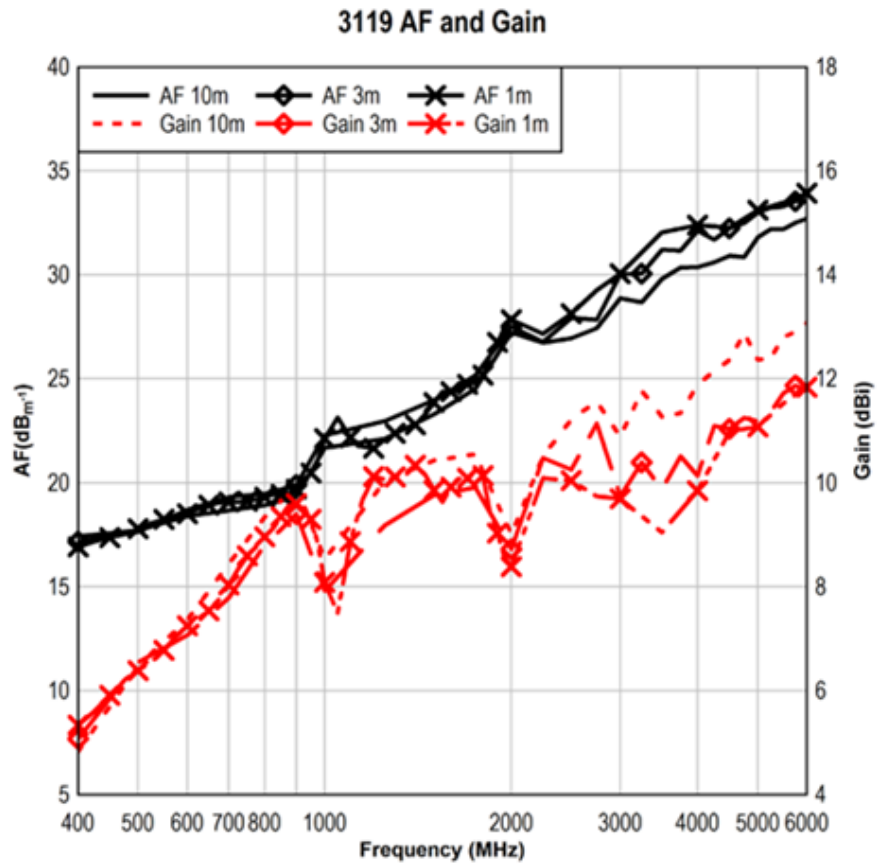

3119 Half Power Beamwidth

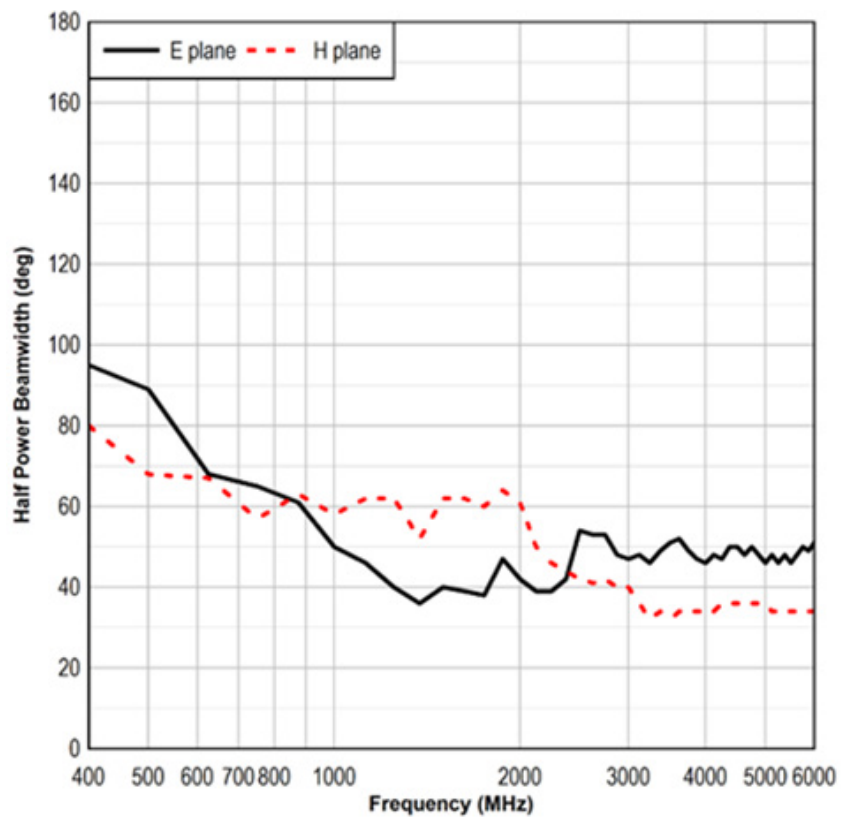

3119 VSWR

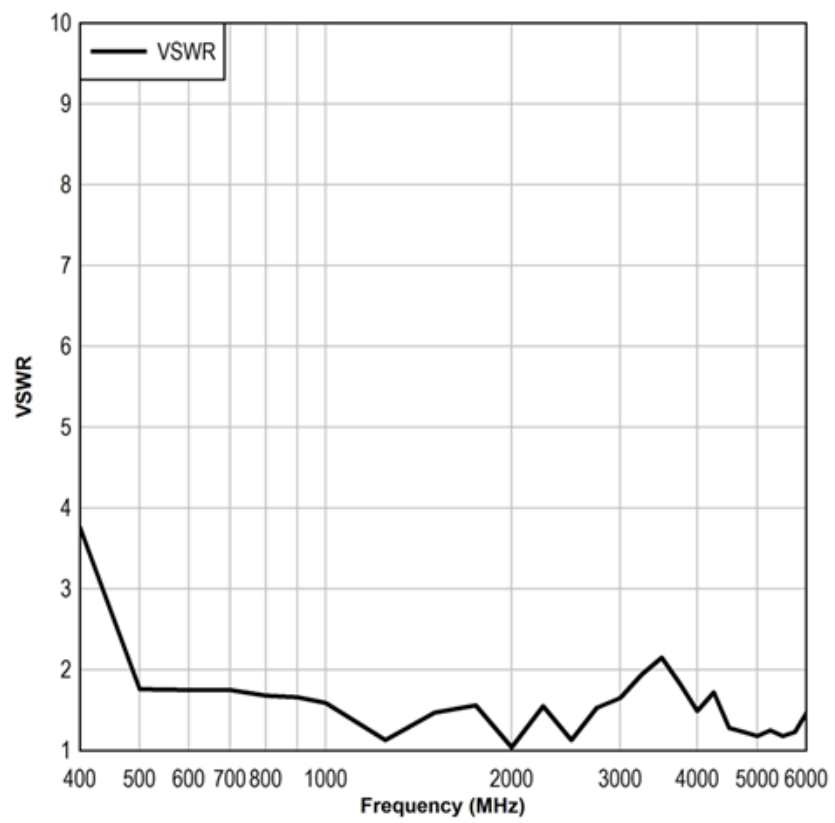

APPENDIX A: Typical Measured Radiated Patterns

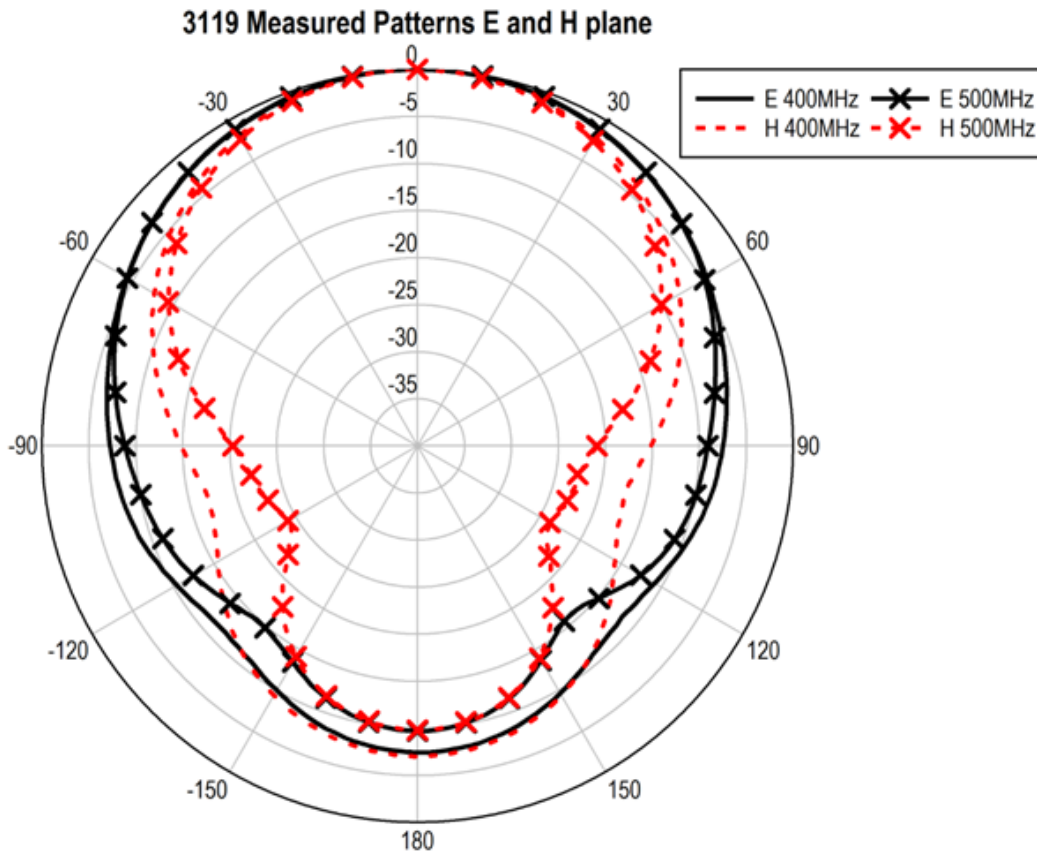

3119 Measured Patterns E and H plane

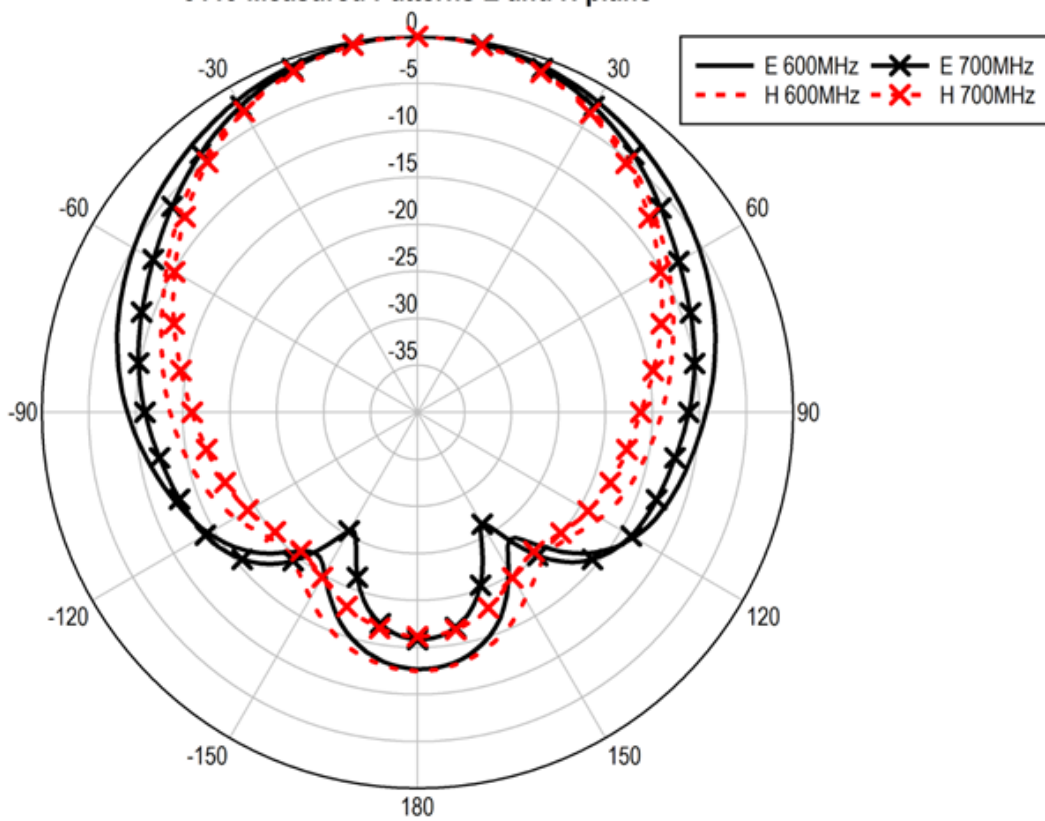

3119 Measured Patterns E and H plane

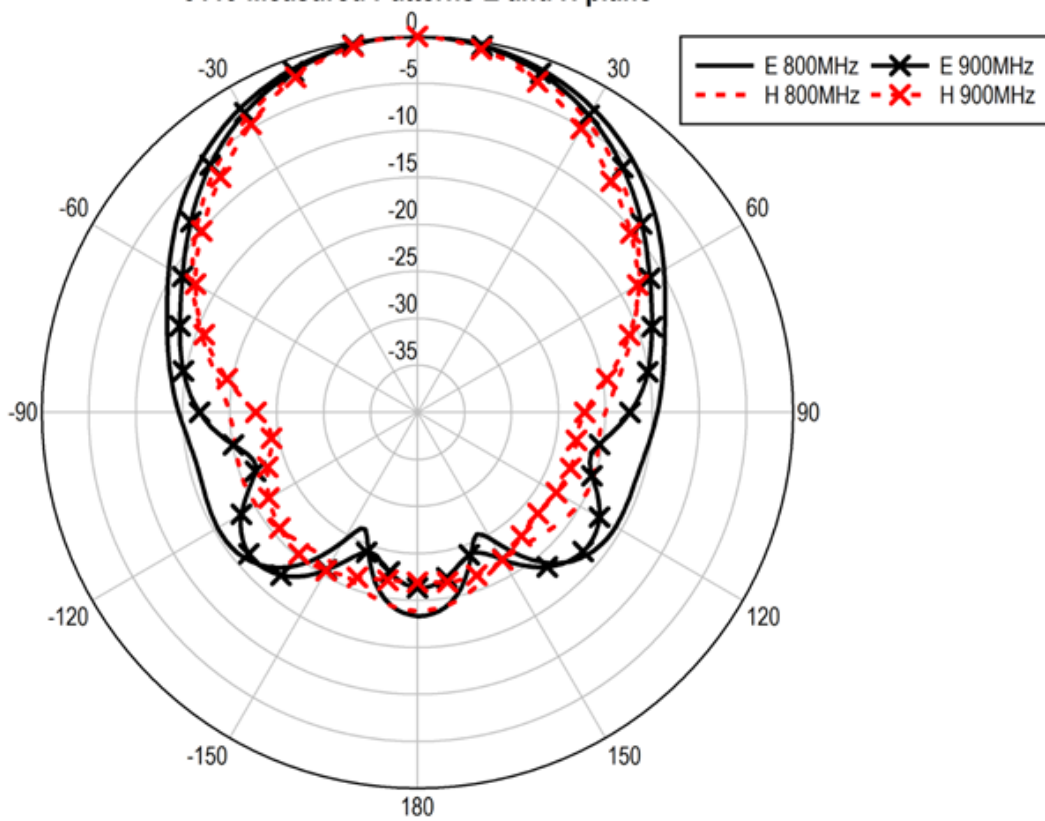

3119 Measured Patterns E and H plane

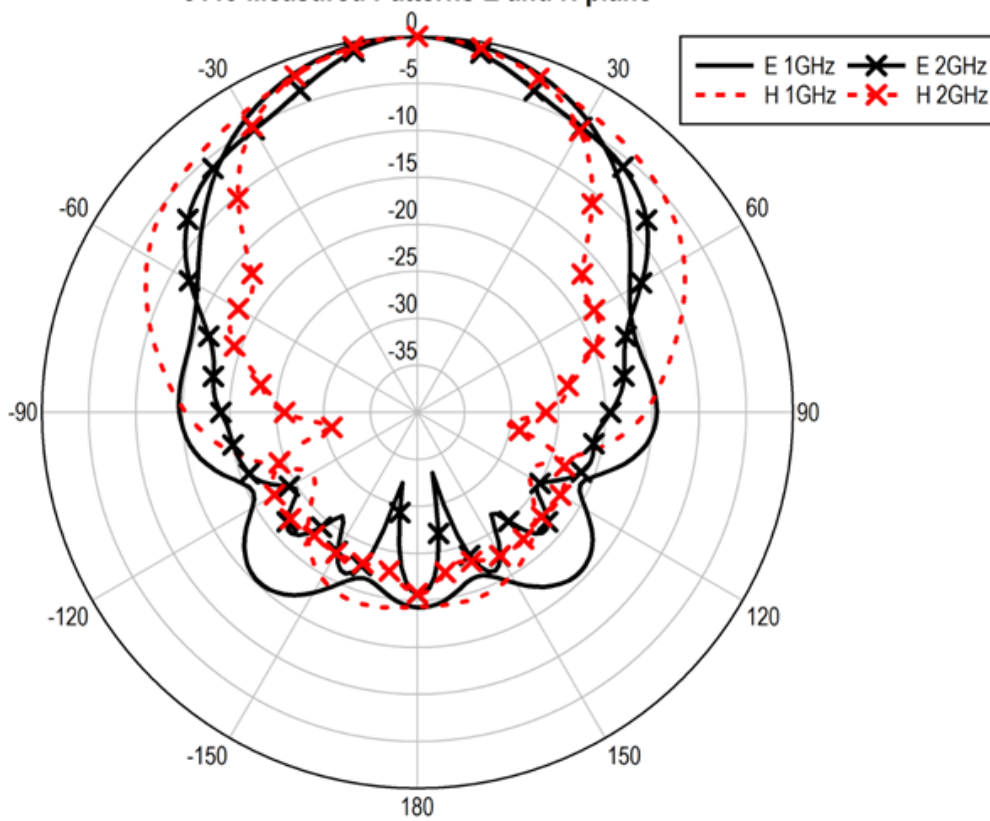

3119 Measured Patterns E and H plane

